



ADVANCING
ALTERNATIVES



2020 PRODUCT CATALOG



INNOVATE / GROW / ADVANCE

Let's grow together...

For over 20 years, we have been serving the North American commercial greenhouse and horticulture industries. As the needs of growers and farmers have grown and changed, so have we. Today, as always, our offerings are being developed, and expanded to new applications, so we remain exceedingly responsive to our valued customers. Our innovative natural ventilation curtain systems and associated products complement any horticultural/agricultural structure. Our specialties include: Touchscreen Environmental Controls, Low Voltage Drive Motors, and Natural Ventilation systems.

From our popular Roll Lock Curtain system to our Rack & Pinion Systems, we promote the use of nature's sunlight and breezes allowing our customers to realize healthier, and more energy-efficient, greenhouse operations. Whether you have a small high tunnel or an expansive range, let us help you create your perfect environment. We provide powerful touchscreen control systems, from our essential all-in-one Aegis TEC to our Aegis Pro TEC, our most comprehensive, multi-zone controller, that can control over 60 assets.

We invite you to explore our environmental control line starting on page 14. Pages 24-27 present our 24 V DC drive motors for ventilation curtains and rack & pinion vents. Advancing Alternatives' drive motors are built to withstand the rigors of commercial growing and are backed by a 4-year warranty. To help you achieve the highest crop quality, we have included on pages 46-51 our louvers, fans, and heaters. We understand that there is no single solution to every grower's need; however, our Technical Design Team is ready and prepared to help you determine the control system that best fits your operation and budget.

Thank you for choosing Advancing Alternatives for your greenhouse needs. Our customers are our top priority, and our goal is 100% customer satisfaction.

Table of Contents

Curtain Packages.....	pages 4-13
Controls	pages 14-23
Low Voltage Motors.....	pages 24-27
Manual Gear Cranks.....	pages 28-33
Steel & Aluminum.....	pages 34-41
Wire & Poly Products.....	pages 42-43
Wind Control	pages 44-45
Fans & Heaters	pages 46-47
Hardware Goods.....	pages 48-51







Curtain Packages

A Staple of Advancing Alternatives

Natural Greenhouse Curtain Ventilation

Advancing Alternatives' curtain ventilation systems allow for air movement across the width of your entire greenhouse. As the width is the shortest dimension, the new air will heat up less than air moving along the entire length of a greenhouse (as is common with mechanical systems).

The natural ventilation provided by our curtain systems serves four crucial horticultural functions: temperature control, improved air circulation, humidity control, and carbon dioxide (CO₂)/oxygen (O₂) exchange.

Greenhouses accept and trap solar radiation, thereby raising the temperature in the environment. High temperatures can be detrimental to plant growth and/or plant health. Our natural ventilation systems provide a means to exhaust excess heat from your greenhouse. Plants benefit from breezes in terms of transpiration and cell wall strengthening. Air moving and blending throughout a greenhouse balances temperatures, humidity, carbon dioxide, and oxygen, thus creating uniform conditions, which makes for healthier plants.

Without adequate ventilation, the humidity will build up in a greenhouse. The transpiration of plants naturally increases humidity levels, as does the inherent condensation occurring within a thermally dynamic structure. High humidity levels in a greenhouse invite pathogens, molds, and fungi that can interfere with plant growth. Humidity control can be automated by using a curtain ventilation system.

Lastly, fresh air provides the CO₂ that is critical for photosynthesis and the oxygen required for root growth. The introduction of fresh air and the exhaustion of stale air, achieved by a well-ventilated greenhouse, increase the health and quality of your greenhouse crop.

Freestanding Greenhouse Ventilation Curtains



Versatility of our system

- Our signature freestanding curtain package means energy savings to the grower.
- Roll Bar locking extrusion that seals the bottom of the curtain opening in the closed position.
- Add two-layer poly inflation of the curtain, two-layer end panels and create a thermal seal around the perimeter of the curtain.
- Automate for crop quality control. (See pages 14-27)
- Guide pipe extension (page 33) to reduce binding of the roll bar.

Note: for special projects or custom solutions please contact us at sales@advancingalternatives.com

ITEM CODE	TOP ATTACHMENT	ROLL BAR	END PANEL EXTRUSIONS	HARDWARE & TEK SCREWS	ZIG ZAG WIRE	ROLL LOCK
82-D-1.3-	Double Wire Lock	1.3 Galv.	Yes	Yes	Yes	No
82-D-SC-	Double Wire Lock	Side Clasp	Yes	Yes	Yes	No
82-DL-1.3-	Double Wire Lock	1.3 Galv.	Yes	Yes	Yes	Yes
82-DL-SC-	Double Wire Lock	Side Clasp	Yes	Yes	Yes	Yes

CURTAIN LENGTHS IN FEET

24	32	40	48	56	64	72	80	88	96	104	112	120	128	136	144	152	160	168	176	184	192	200
----	----	----	----	----	----	----	----	----	----	-----	-----	-----	-----	-----	-----	-----	-----	-----	-----	-----	-----	-----

Curtain Packages

Gutter-Connected Greenhouse Ventilation Curtains



Versatility of our system

- Our gutter-connect curtain means energy savings to you the grower.
- Includes our Roll Lock that seals the bottom of the curtain opening in the closed position.
- Add two-layer poly inflation of the curtain, two-layer end panels and create a thermal seal around the perimeter of the curtain.
- Automate for crop quality control (See pages 14-27)

Note: for special projects or custom solutions please contact us at sales@advancingalternatives.com

ITEM CODE	TOP ATTACHMENT	ROLL BAR	END PANEL EXTRUSIONS	HARDWARE & TEK SCREWS	ZIG ZAG WIRE	ROLL LOCK
82-S-1.3-	Single Wire Lock	1.3 Galv.	Yes	Yes	Yes	No
82-S-SC-	Single Wire Lock	Side Clasp	Yes	Yes	Yes	No
82-SL-1.3-	Single Wire Lock	1.3 Galv.	Yes	Yes	Yes	Yes
82-SL-SC-	Single Wire Lock	Side Clasp	Yes	Yes	Yes	Yes

CURTAIN LENGTHS IN FEET

24	32	40	48	56	64	72	80	88	96	104	112	120	128	136	144	152	160	168	176	184	192	200
----	----	----	----	----	----	----	----	----	----	-----	-----	-----	-----	-----	-----	-----	-----	-----	-----	-----	-----	-----

Curtain Wall Packages



Curtain Wall System Provides:

A full opening curtain for greater access and ventilation. Provides convenient through-ways for garden center customers, materials, and products.

The convertible partitioning of a multi-bay greenhouse from a single climate zone to multiple zones. Creates a scalable operation within the overall greenhouse footprint. Provides energy savings by isolating unused greenhouse space.

Package Features:

- Double bar systems with two style options.
- Bottom weight bar or chain threshold (best for uneven grade).
- Reinforced polyethylene or vinyl fabric options.
- Wind control at posts and end walls.
- Operator enclosure panels available.
- Manual or motorized operation. (See pages 24-31)



**Keder curtain wall shown above*

ITEM CODE	TOP ATTACHMENT	ROLL BAR	BOTTOM BAR	CHAIN THRESHOLD	ZIG ZAG WIRE
82-CWK-1.3-	Keder	Keder	1.3 Galv.	No	No
82-CWK-1.3T-	Keder	Keder	1.3 Galv.	Yes	No
82-CWK-K-	Keder	Keder	Keder	No	No
82-CWSC-SC-	Single Wire Lock	Side Clasp	Side Clasp	No	Yes
82-CWSC-SCT-	Single Wire Lock	Side Clasp	Side Clasp	Yes	Yes

CURTAIN LENGTHS IN FEET

24	32	40	48	56	64	72	80	88	96	104	112	120	128	136	144	152	160	168	176	184	192	200
----	----	----	----	----	----	----	----	----	----	-----	-----	-----	-----	-----	-----	-----	-----	-----	-----	-----	-----	-----

Curtain Packages

Evaporative Pad Curtain



Evaporative Pad Curtain:

Maximize the efficiency of your system by creating an unobstructed flow of air through evaporative pads. Can easily interface with existing environmental controls. Use blackout fabric in the system for a light deprivation greenhouse.

Note: All evaporative cooling packages utilize our side clasp roll bar and roll lock.

ITEM CODE	TOP ATTACHMENT	ROLL BAR	BRUSH SEALS	HARDWARE & TEK SCREWS	ZIG ZAG WIRE	ROLL LOCK
82-ECCP-	Single Wire Lock	Side Clasp	Yes	Yes	Yes	Yes

ITEM CODE	LENGTH IN FEET													
82-ECCP-	16	20	24	28	32	36	40	48	52	56	60	64	68	72



Rack & Pinion Roof Vent System

With sidewall ventilation, create the highest level of natural ventilation efficiency. All driven by our rugged low voltage motors and controlled by one of our Aegis controllers.

A hinged style roof vent for poly-covered greenhouses. Includes framing, vent arms, poly-locking extrusion and wire, inflation relief valve, drive shaft, hangers, racks and pinions.



Curtain Packages

Rack & Pinion Vent System



Rack & Pinion System Features

- Vent arms
- Vent sash framing and sill members
- Poly-locking extrusions and wire
- 4' or 6' bow spacing packages
- Racks, pinions, drive shaft and shaft hangers
- Hardware
- Inflation relief valve



**Note: Fabric is custom order per project, motors and controls must also be purchased separately and sized per project.*

ITEM CODE	ALUMINUM FRAME	VENT ARMS	SHAFT HANGERS	SPACING	HARDWARE	LENGTH IN FEET								
82-RP4-	Yes	Yes	Yes	4' O.C.	Yes	48	60	72	84	96	108	120	132	144
82-RP6-	Yes	Yes	Yes	6' O.C.	Yes	48	60	72	84	96	108	120	132	144



Light Deprivation Roll-to-Peak System

Control your crop's flowering schedule with the system that offers the best value and reliability. Completely automated light deprivation for the exterior of the greenhouse, which gives you more interior room for lighting systems and your crop. Our perimeter seal design provides wind control and prevents light leakage as well as two innovative roll bar options that reduce deflection and add strength.



Curtain Packages

Light Deprivation

Light Deprivation Systems

Light dep package includes the following hardware and components:

- Aluminum extrusions for fastening curtain fabric to the peak.
- Double wire lock with back bolt channel for easy strap attachment to bows.
- Internally spliced Side Clasp Roll Bar distributes torque evenly over long curtain lengths.
- Wind control, including lashing winches, that allow for adjustment of high-test webbing.
- Light seal system that inflates two layers of poly (poly or fabric ordered separately) that puts pressure on the curtain's perimeter.
- Self-tapping fasteners and Zig Zag Wire inserts.

**Note: Fabric is custom order and non-returnable per project. Motors and controls must also be purchased separately and sized per project.*

ITEM CODE	LENGTH IN FEET													
83-HDLLD-	48	56	64	72	80	88	96	104	112	120	128	136	144	

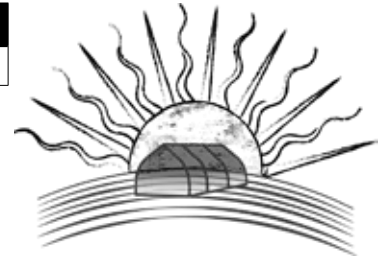

42-CLD-2MO

The CLD-2MO is designed to control two low voltage motors on a roll to peak light deprivation system. This controller features a digital timer which can run multiple timed cycles per day. There is also a manual override function on the controller for motors and for the timer.

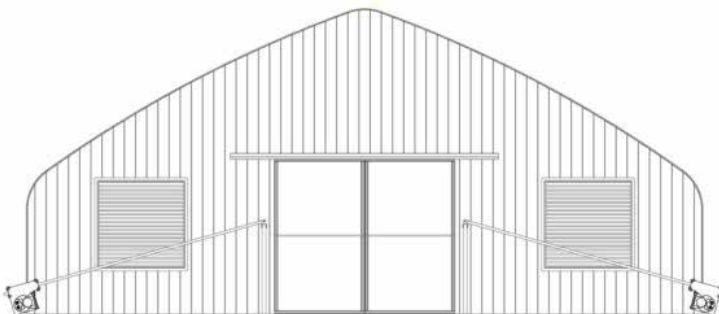

69-GPSBA

Guide pipe swivel bracket assembly.

71-GPSA

Guide pipe swing arm assembly.

71-GPT8

Telescoping arm for motors.

Controls

Our climate and timed controls effectively support and protect your crops. Wind, rain, and humidity manual overrides are incorporated so you can personally control your greenhouse system as desired. Stage, coordinate, override, and time (DIF) your cooling, heating, and light deprivation operations with our touchscreen controllers!

Want to expand your cooling capabilities? Upgrade to our 24V DC ventilation motors and controller interface boxes! They're designed to work with existing thermostatic controls.

SIMPLE TO USE GREENHOUSE AUTOMATION

Whether you're controlling by a simple manual switch or full automation, we make managing your greenhouse environment straightforward and uncomplicated.

Power by plugging into a standard receptacle or a solar power system. Enjoy the convenience of a touch-screen interface with easy-to-understand parameter settings. Rest assured that your Advancing Alternatives' ventilation drives are properly fused and supplied with the 24 VDC power they need.



Touchscreen Controls.....pgs 16-18
LED Controlspg 19
Manual Controlspg 20
Sensors.....pg 21
Solar Powerpgs 22-23

Aegis TEC Controller

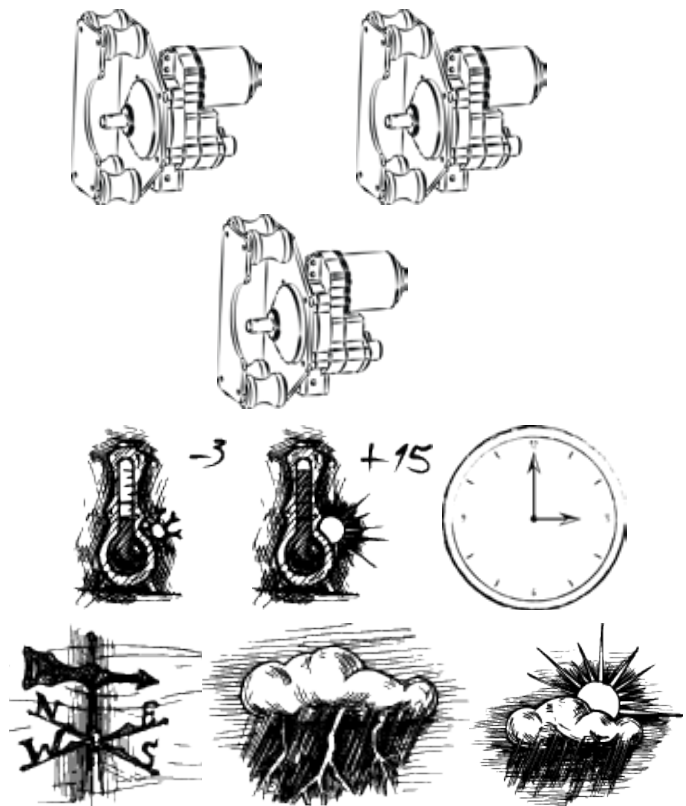

Controller Features:

- User-friendly touchscreen interface.
- Manual Override.
- Single-growing zone design.
- Easy set-up for various heating and cooling schemes.
- Simple to program set points, vent drive run times, and sensor reading intervals.
- Provides power for up to three (3) 100Nm - 24V DC vent motors.
- Controls motors, fans, heaters, HAF's, CO2 generators, dehumidifiers, pad pumps, etc.
- Wind, rain, and humidity override sensors available.
- DIF growing and light deprivation ready.
- Ability to run 2 temperature sensors.
- 2-year limited warranty.
- 100' temperature sensor included.
- Easy integration into your existing 110/220 V AC system.

ITEM CODE	SCREEN	SUPPLY POWER	MOTORS	OUTPUT POWER	WATT	CIRCUIT PROTECTION
41-AEGISTEC	LED	110AC 220AC	3*	24V DC	300	Resettable

*Up to 3 motors, depending on how many other assets are being utilized. For more information please contact us. sales@advancingalternatives.com

Controllers

Aegis TEC+ Controller

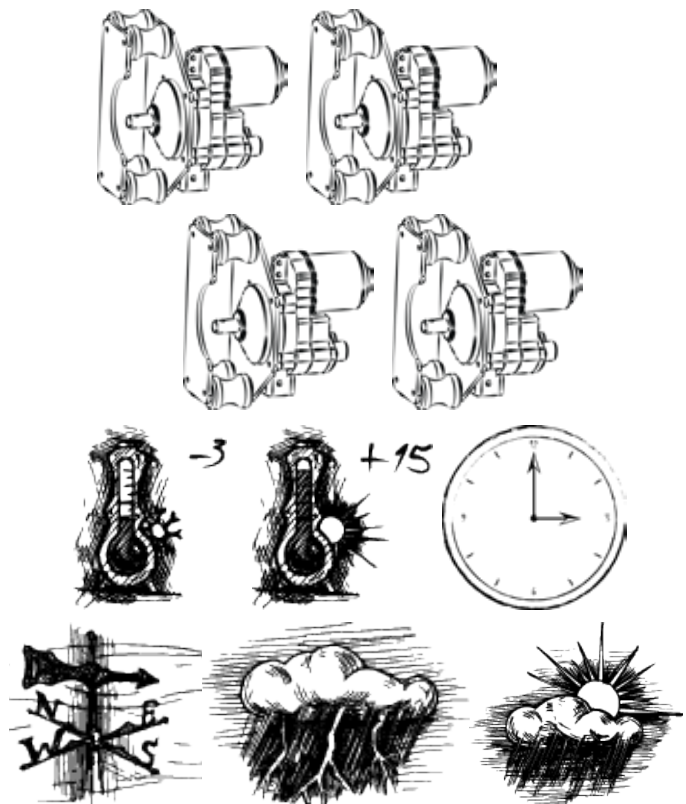

Controller Features:

- User-friendly touchscreen interface.
- Manual override.
- Single or dual-growing zone design.
- Easy set-up for various heating and cooling schemes.
- Simple to program set points, vent drive run times, and sensor reading intervals.
- Provides power for up to four (4) 24V DC vent motors*.
- Controls motors, fans, heaters, HAF's, CO2 generators, dehumidifiers, pad pumps, etc.
- Wind, rain, and humidity override sensors available.
- DIF growing and light deprivation ready.
- 2-year limited warranty.
- 100' temperature sensor included.
- Ability to run 2 temperature sensors.
- Easy integration into your existing 110/220 V AC system.

ITEM CODE	SCREEN	SUPPLY POWER	MOTORS	OUTPUT POWER	WATT	CIRCUIT PROTECTION
41-AEGISTECP	LED	110AC 220AC	4*	24V DC	600	Resettable

*Up to 4 motors, depending on how many other assets are being utilized. For more information please contact us. sales@advancingalternatives.com

Aegis Pro TEC

Aegis ProTEC



Pro TEC Features:

Custom designed for up to 8 individual zones with multiple assets!

The Aegis Pro TEC places centralized monitoring and individual zone control at your fingertips. Environmental automation made simple with the user-friendly touchscreen interface, custom designed to fit your needs. The Aegis Pro TEC is ready to grow with your business. Use in a single zone or expand up to eight individual zones. Stage, coordinate, time, and override your cooling, heating, and light deprivation assets. The hierarchy program structure places the parameter settings you need most at the top of the list.

- Automation control of up to 32 low voltage motors* and 64 additional assets*.
- Manual override for every asset in each zone.
- 8 parameter settings per asset.
- Indoor temperature and humidity sensor included.
- Outdoor temperature, rain, and wind sensors available.
- Temperature, humidity, wind, rain, and time overrides.

ITEM CODE	SCREEN	SUPPLY POWER		MOTORS	OUTPUT POWER	WATT	CIRCUIT PROTECTION
41-AEGISPT	Touch	110AC	220AC	up to 32*	24V DC	Custom	Resettable

*Up to 4 motors & 8 additional assets per zone control box

For more information please contact us. sales@advancingalternatives.com

Controllers

VCU 2-24

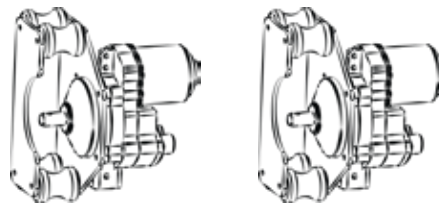

Controller Features:

- LED display.
- Controls up to 2 motors* and 2 dry contact devices.
- Holds programming in power outage.
- Variable vent motor run time (incremental opening).
- Variable pause interval between vent opening.
- Optional humidity sensor override.
- Quick & easy programming.
- Manual override feature.
- 2-year limited warranty.
- 100' temperature sensor included.

ITEM CODE	SCREEN	SUPPLY POWER	MOTORS	OUTPUT POWER	WATT	CIRCUIT PROTECTION	
41-VCU2-24	LED	110AC	220AC	2*	24V DC	300	Resettable

*Up to 2 motors, depending on how many other assets are being utilized. For more information please contact us. sales@advancingalternatives.com.

Other Controller Options



Switch Relay Transformer Boxes

Our manually operated SRTB's provide all the power you need to operate a single or dual 60 or 100 Nm operator system. Built-in motor protection from power surges and overloads. You are also protected with our industry-leading 2-year limited warranty.

ITEM CODE	MOTORS	OUTPUT POWER	CIRCUIT PROTECTION
43-SRTB1-24	1(60 or 100Nm)	24V DC	Fuses
43-SRTB1-24-LM	1(60 or 100Nm)	24V DC	Fuses
43-SRTB2-24	2(60 or 100Nm)	24V DC	Fuses



Controller Interface Boxes

We've made it easy for you to upgrade your greenhouse cooling with our LVM (24V DC) ventilation drive motors. Our CIB's are designed for a smooth transition to 24V DC power for ventilation curtains or rack and pinion vents. Your existing environmental controller sends the open/close signal and the CIB does the rest.

ITEM CODE	MANUAL OVERRIDE	MOTORS	OUTPUT POWER	CIRCUIT PROTECTION
42-CIB1-24	No	1(60 or 100Nm)	24V DC	Fuses
42-CIB1-24MO	Yes	1(60 or 100Nm)	24V DC	Fuses
42-CIB2-24	No	2(60 or 100Nm)	24V DC	Resettable
42-CIB2-24MO	Yes	2(60-180Nm)	24V DC	Resettable



CIBAC 2F2L

Our CIBAC boxes make it easy to incorporate your existing 120/240V AC fans and louvers into our 24V DC automation system.

With multiple instock CIBAC boxes and our ability to make custom boxes, rest assured that we have you covered when it comes to operating your assets with our environmental controls.

ITEM CODE	FANS	LOUVERS	HAF FANS	EVAP PAD	GROW LIGHTS
42-CIBAC-1F1L	1	1			
42-CIBAC-2F2L	2	2			
42-CIBAC-6F220V	3	3			
42-CIBAC-MASTER	2	2	2	1	5

Visit www.advancingalternatives.com for pricing information.

Controllers

Automation Upgrades



46-HUMID
Humidity Sensor

Used with:
Aegis TEC Plus, Aegis TEC, VCU 2/24

46-RS
Rain Sensor

Used with:
Aegis TEC Plus, Aegis TEC



46-WIND
Wind Sensor

Used with:
Aegis TEC Plus, Aegis TEC

46-TS100
46-TS150
Temperature Sensor in either 100' or 150' lengths.

Used with:
Aegis TEC Plus, Aegis TEC, VCU 2/24



61-LSARL-LVM



Used with:
Low Voltage Motor 60, 100, 100-2D, 180, and 200 Nm vent drive motors.
*For best results use with Roll Lock extrusion (pg 37)

61-LSARL-LVM-RP

Used with:
Low Voltage Motor 100SRP and 200SRP rack and pinion vent drives.
*Note: This limit switch does come in Rack & Pinion packages.



Solar Kits



We have solar kits available for 2 or 4 motors!

Solar Kit Features

- 140 Watt Solar Panel
- 12V Battery.
- Controller for 2-4 motors.
- Charge controller.
- Manual override capability.
- Optional humidity control and rain override.
- Optional solar panel mounting kit.

Solar Powered

The same energy that warms your greenhouse can now cool your greenhouse. Harness the sun's rays to power your curtain or roof vent system. Intended for greenhouses that have no access to conventional electricity or for those wanting the highest level of energy efficiency.



Solar Power

Solar Controllers



ITEM CODE	SCREEN	SUPPLY POWER	MOTORS	OUTPUT POWER	CIRCUIT PROTECTION	STEP UP TRANSFORMER	CHARGE CONTROLLER
44-12VDC-ATEC	Touch	12V	3	24V DC	Resettable	Yes	No
44-12VDC-ATECP	Touch	12V	4	24V DC	Resettable	Yes	No
44-12VDC-VCU2	LED	12V	2	24V DC	Resettable	Yes	No
44-12VDC-CIB	N/A	12V	2	24V DC	Resettable	Yes	No
44-12VDC-CLD	N/A	12V	2	24V DC	Resettable	Yes	No
44-24VDC-ATEC	Touch	24V	3	24V DC	Resettable	No	No
44-24VDC-ATECP	Touch	24V	4	24V DC	Resettable	No	No
44-24VDC-CIB	N/A	24V	2	24V DC	Resettable	No	No
44-24VDC-VCU2	LED	24V	2	24V DC	Resettable	No	No
44-24VDC-CLD	N/A	24V	2	24V DC	Resettable	No	No
44-SVC-ATEC	Touch	12V	3	24V DC	Resettable	Yes	Yes
44-SVC-ATECP	Touch	12V	4	24V DC	Resettable	Yes	Yes
44-SVC-VCU2	LED	12V	2	24V DC	Resettable	Yes	Yes
44-SVC-CLD	N/A	12V	2	24V DC	Resettable	Yes	Yes
44-SVK-ATEC	Touch	12V	3	24V DC	Resettable	Yes	Yes
44-SVK-ATECP	Touch	12V	4	24V DC	Resettable	Yes	Yes
44-SVK-VCU2	LED	12V	2	24V DC	Resettable	Yes	Yes

Low Voltage Motors

Our line of low voltage motors have been specially designed to meet the unique demands of the greenhouse and high tunnel. They provide all the torque needed to drive ventilation, shade and light deprivation systems. They're specific lightweight construction is designed to minimize structural forces and make for easier installation.

Single shaft motors are available in 60 Nm, 100 Nm, and 180 Nm. Dual-shaft motors are available in 100 Nm and 200 Nm. We offer a four-year limited warranty on low voltage motors when used in conjunction with one of our greenhouse ventilation controllers. You can automate using one of our environmental controllers or integrate into your existing system with our controller interface box.

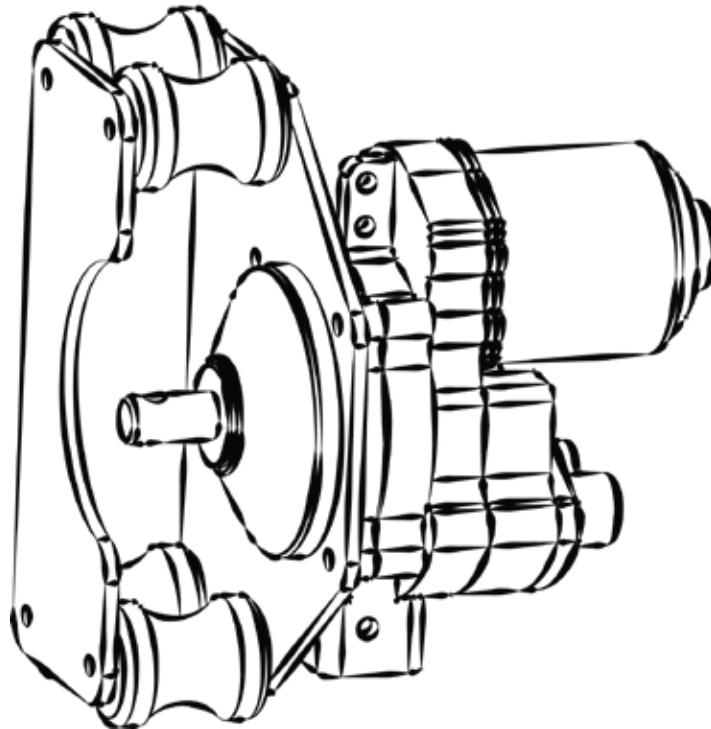



60Nm - 100 Nm

Curtain Drive Motors

- 24 Volt DC.
- 4-year limited warranty*.
- High torque output in a compact design.
- Easy access limit switches (directional limits).
- Guide wheel assembly for left or right output.
- Multiple roll bar diameter adapters available.
- Single and dual output shafts available.



*When used with an Advancing Alternative controller.

ITEM NUMBER	AMPS	WATT	OUTPUT TORQUE/SPEED	MOUNTING	OUTPUT	SHAFT	ADAPTERS
61-LVM60	3	72	60Nm / 2.7 RPM	None	Single	20mm	Various
61-LVM60-GW	3	72	60Nm / 2.7 RPM	Guidewheel	Single	20mm	Various
61-LVM100	4.2	100	100Nm / 3 RPM	None	Single	20mm	Various
61-LVM100-GW	4.2	100	100Nm / 3 RPM	Guidewheel	Single	20mm	Various
61-LVM1002D	4.2	100	100Nm / 3 RPM	None	Dual	20mm	Various
61-LVM1002D-GW	4.2	100	100Nm / 3 RPM	Guidewheel	Dual	20mm	Various

20mm Roll Bar Adapters for Motors

ITEM NUMBER	ROLL BAR STYLE	MOTOR SHAFT
65-RBA20M-1.3	1.315" OD Roll Bar	20mm
65-RBA20M-1.5	1.5" OD Aluminum Bar	20mm
65-RBA20M-1.6	1.66" OD Roll Bar	20mm
65-RBA20M-K	2" Keder Aluminum Bar	20mm
65-RBA20M-SC	2" Aluminum Side Clasp Roll Bar	20mm



Motors & Adapters

180Nm - 200Nm

Adjustable and stationary mounting brackets are available for our motors.

Large Curtain Motors

- 24 Volt DC.
- 4-year limited warranty*.
- High torque output in a compact design.
- Easy access limit switches (directional limits).
- Multiple roll bar diameter adapters available.



**When used with an Advancing Alternative controller.*

ITEM NUMBER	AMPS	WATT	OUTPUT TORQUE/SPEED	MOUNTING	OUTPUT	SHAFT	ADAPTERS
61-LVM180	8.3	200	180Nm 4.5 RPM	None	Single	22mm	Various
61-LVM180-GW	8.3	200	180Nm 4.5 RPM	Guidewheel	Single	22mm	Various
61-LVM200	10.2	250	200Nm 4.5 RPM	None	Dual	22mm	Various
61-LVM200-GW	10.2	250	200Nm 4.5 RPM	Guidewheel	Dual	22mm	Various

Rack & Pinion Motors

- 24 Volt DC.
- 4-year limited warranty*.
- Easy access limit switches (directional limits).
- Multiple roll bar diameter adapters available.



**When used with an Advancing Alternative controller.*

ITEM NUMBER	AMPS	WATT	OUTPUT TORQUE/SPEED	MOUNTING	OUTPUT	SHAFT	ADAPTERS
61-LVM100-SRP	4.2	100	100Nm 3 RPM	Stationary	Dual	20mm	Various
61-LVM200-SRP	10.2	250	200Nm 4.5 RPM	Stationary	Dual	22mm	Various

22mm Roll Bar Adapters for Motors

ITEM NUMBER	ROLL BAR STYLE	MOTOR SHAFT
65-RBA22M-1.3	1.315" OD Roll Bar	22mm
65-RBA22M-1.5	1.5" OD Aluminum Bar	22mm
65-RBA22M-1.6	1.66" OD Roll Bar	22mm
65-RBA22M-K	2" Keder Aluminum Bar	22mm
65-RBA22M-SC	2" Aluminum Side Clasp Roll Bar	22mm

Manual Gear Cranks

Operating your manual ventilation system requires the right gear ratio and mounting method.

Whether you require guide wheels for a curtain operation or mounting plates for a stationary, drive shaft operation, we have the right manual operator for you.

Gears	pg 30
Adapters.....	pg 31
Chain Wheels.....	pg 32
Guide Pipe.....	pg 33
Crank Handles	pg 32





Gear Cranks



Manual Gear Crank with Handle Brake, Single Output

These gears DO NOT have an internal brake. The handle slides to create a locking mechanism. (As seen on pg 31)

*Note: These gears take a 5/8" adapter (see top of page 31)

*Left output gear shown

ITEM NUMBER	RATIO	OUTPUT	MOUNTING	CURTAIN LIFT
63-GC5-1L	5:1	Left	Guidewheel	750 sqft
63-GC5-1R	5:1	Right	Guidewheel	750 sqft
63-GC10-1L	10:1	Left	Guidewheel	1200 sqft
63-GC10-1R	10:1	Right	Guidewheel	1200 sqft

Manual Gear Crank with Internal Brake, Single and Dual Output

These gears have an internal brake. *Note: These gears take a 1/2" adapter (see bottom of page 31)

ITEM NUMBER	RATIO	MOUNTING	OUTPUT	CURTAIN LIFT
63-GC7-1	7:1	Guidewheel	Single	500 sqft
63-GC7-1S	7:1	Stationary	Single	500 sqft
63-GC7:1SH (Short Handle)	7:1	Guidewheel	Single	500 sqft
63-GC13-1	13:1	Guidewheel	Single	1200 sqft
63-GC13-1S	13:1	Stationary	Single	1200 sqft
63-GC13-1SH (Short Handle)	13:1	Guidewheel	Single	1200 sqft
63-GC13-12D	13:1	Guidewheel	Dual	1200 sqft
63-GC13-12DSH (Short Handle)	13:1	Guidewheel	Dual	1200 sqft
63-GC15-12D	15:1	Guidewheel	Single/Dual	1500 sqft
63-GC15:1S	15:1	Stationary	Single/Dual	1500 sqft
63-GC15-1SH (Short Handle)	15:1	Guidewheel	Single/Dual	1500 sqft
63-GC30-12D	30:1	Guidewheel	Single/Dual	2000 sqft
63-GC30-1S	30:1	Stationary	Single/Dual	2000 sqft



7:1 Manual gear crank.



13:1 Manual gear crank with roll bar adapter and short crank handle.



15:1 Dual output manual gear crank shown with dual roll bar adapter.

*Right output gear shown above

*Left output gear shown above

Gear Cranks & Adapters

Roll Bar Adapters

ITEM NUMBER	ROLL BAR STYLE	GEAR SHAFT	INSIDE DIAMETER
65-RBA58R-1	1" OD Roll Bar	5/8"	.9" round
65-RBA58R-1.3	1.315" OD Roll Bar	5/8"	1.158" round
65-RBA58R-1.6	1.66" OD Roll Bar	5/8"	1.482" round
65-RBA58R-K	2" Keder Aluminum Bar	5/8"	N/A
65-RBA58R-SC	2" Aluminum Side Clasp Roll Bar	5/8"	1.25" square



ITEM NUMBER	SHAFT	ROLL BAR STYLE	GEAR SHAFT	INSIDE DIAMETER
65-RBA12-1	Single	1" OD Roll Bar	1/2"	.9" round
65-RBA12-1.3	Single	1.315" OD Roll Bar	1/2"	1.158" round
65-RBA12-1.6	Single	1.66" OD Roll Bar	1/2"	1.482" round
65-RBA12-K	Single	2" Keder Aluminum Bar	1/2"	N/A
65-RBA12-SC	Single	2" Aluminum Side Clasp Roll Bar	1/2"	1.25" square
65-RBA12D-1	Dual	1" OD Roll Bar	1/2"	.9" round
65-RBA12D-1.3	Dual	1.315" OD Roll Bar**	1/2"	1.158" round
65-RBA12D-1.6	Dual	1.66" OD Roll Bar	1/2"	1.482" round
65-RBA12D-K	Dual	2" Keder Aluminum Bar	1/2"	N/A
65-RBA12D-SC	Dual	2" Aluminum Side Clasp Roll Bar	1/2"	1.25" square

Visit www.advancingalternatives.com for pricing information.

Gears & Handles



Chain Wheel Operators

Available in 10:1 and 15:1 gear ratios with single or dual output shafts. Can be configured with roller guide wheels or stationary mounting assemblies. All configurations include 26' of chain and the chain keeper.

ITEM NUMBER	GEAR	CHAIN LENGTH	MOUNTING	OUTPUT	MAX CURTAIN LIFT	ADAPTERS
63-GCW10-1	10:1	26'	Guidewheel	Single/Dual	1200 sqft	Various, use 5/8" adapters (pg 31)
63-GCW10-1S	10:1	26'	Stationary	Single/Dual	1200 sq ft	Various, use 5/8" adapters (pg 31)
63-CGW15-1	15:1	26'	Guidewheel	Single/Dual	1500 sqft	Various, use 1/2" adapters (pg 31)
63-CGW15-1S	15:1	26'	Stationary	Single/Dual	1500 sq ft	Various, use 1/2" adapters (pg 31)

Long Handled Gear Cranks

For harder to reach applications. These single output, 7:1 gears can be used with all our single output adapters. (bottom pg 31)



ITEM NUMBER	HANDLE LENGTH	MAX CURTAIN LIFT	ADAPTERS
63-GCLH4	4'	500sqft	Various
63-GCLH8	8'	500sqft	Various

Crank Handles

ITEM CODE	2'	4'	6'	8'	10'
64-CH					



Drill Crank Handles

ITEM CODE	2'	4'	6'	8'	10'
64-DC					

Gear Cranks & Accessories

Guide Pipe & Accessories

ID NO.	PIPE DIAMETER	PIPE LENGTH	HANGING HARDWARE INCLUDED
71-GP7	1.315" Outside Diameter	7'	No
71-GP7A	1.315" Outside Diameter	7'	Yes
71-GP8-9	1.315" Outside Diameter	8'9"	No
71-GP8-9A	1.315" Outside Diameter	8'9"	Yes
71-GP10	1.315" Outside Diameter	10'	No
71-GP10A	1.315" Outside Diameter	10'	Yes
71-GP12	1.315" Outside Diameter	12'	No
71-GP12A	1.315" Outside Diameter	12'	Yes



71-GPHO

All the hardware needed to hang your guide pipe from your greenhouse.

71-GPE4

A 4 foot aluminum extender to make hanging your guide pipe easier.



Visit www.advancingalternatives.com for pricing information.





QUALITY

Greenhouse

Extrusions & Tubing

Ventilation, poly-locking, glazing and framing components for upgrades and repairs.

Wire Lock.....	pg 36
Side Clasp Roll Bar.....	pg 37
Roll Lock.....	pg 37
Roll Pipe & Cap	pg 38
H-cap/channel	pg 38
Steel Tube	pg 39
Flare Tube	pg 40
Keder.....	pg 41

Wire Lock Extrusions

72-WL



Single channel extrusion for locking poly with zig zag wire.

SIZES	
8'	12'
SOLD	QTY PER BUNDLE
Each or Bundles	20

72-DWL



Double channel extrusion for locking poly with zig zag wire. Includes splice plate and four tek screws.

SIZES	
8'	12'
SOLD	QTY PER BUNDLE
Each or Bundles	12

72-EBWL



End bow wire lock joins poly roof with polycarbonate end walls. Max bend is a 2 foot radius per piece.

SIZES	
8'	12'
SOLD	QTY PER BUNDLE
Each or Bundle	20



Ventilation Extrusions

Roll Lock System

When used with Side Clasp Roll Bar, Roll Lock creates a snug lock when the curtain is closed. Incorporate our thermal-seal system (22-IF60-SW on pg 42) and you'll greatly reduce heat loss and cold air infiltration.



Roll Lock System

72-SCRB



2" Diameter Side Clasp Roll Bar is the all-in-one aluminum solution for single or double bar curtains.

SIZES		
8'	12'	12HD
SOLD		QTY PER BUNDLE
Each or Bundle		8

72-RL



Roll Lock extrusion includes splice plate and four tek screws.

SIZES	
8'	12'
SOLD	
Each or Bundle	4

72-RLR



Roof Roll Lock extrusion includes splice plate and four tek screws and two bolts and nuts.

SIZES	
8'	12'
SOLD	
Each	

Visit www.advancingalternatives.com for pricing information.

Roll Pipe / Polycarbonate Glazing

71-RP



ID NO.	PIPE DIAMETER	PIPE LENGTH	SWEGED	GAUGE	SOLD
71-RP8-1.3-16	1.315" Outside Diameter	8'	Yes	16	Each
71-RP12-1.3-16	1.315" Outside Diameter	12'	Yes	16	Each
71-RP12-1.3-16B	1.315" Outside Diameter	12'	Yes	16	Bundle (91pcs)
71-RP21-1.3-16	1.315" Outside Diameter	21'	Yes	16	Each
71-RP21-1.3-16B	1.315" Outside Diameter	21'	Yes	16	Bundle (91pcs)
71-RP24-1.3-16	1.315" Outside Diameter	24'	Yes	16	Each
71-RP24-13-16B	1.315" Outside Diameter	24'	Yes	16	Bundle (91pcs)

72-RBC



Pre-drilled every 12"

71-ERB



72-HC



72-HCAP



SIZES	
8'	12'
SOLD	
Each	
QTY PER BUNDLE	
24	

SIZES	
8'	12'
SOLD	
Each	
QTY PER BUNDLE	
8	

SIZES	
8'	12'
SOLD	
Each	
QTY PER BUNDLE	
20	

SIZES	
8'	12'
SOLD	
Each	
QTY PER BUNDLE	
20	

Installation Accessories



Roll Bar Hangers & Accessories

- 9 hangers per pack.
- 48 LF of pipe supported per every 9 hangers.
- Options for every roll bar type.
- Holds roll bar for poly attachment.

ID NO.	ROLL BAR SIZE	DESCRIPTION
23-RPH2X	1.315"	Hangers fit over baseboard to support roll bar installation.
23-RPHJ	1.315"	J shape hangers for center curtain bar support during installation.
23-RPHRL	1.315"	Hangers fit over roll lock extrusion for installation of roll bar.
23-SCH2X	Side Clasp Roll Bar 2"	Hangers fit over baseboard to support roll bar installation.
23-SCHJ	Side Clasp Roll Bar 2"	J shape hangers for center curtain bar support during installation.
23-SCHJLD	Side Clasp Roll Bar 2"	18" J shape hangers for light dep installation.
23-SCHRL	Side Clasp Roll Bar 2"	Hangers fit over roll lock extrusion for installation of roll bar.
23-RPBD	Any	45 degree angle to deflect roll bar over and down the baseboard face.
23-SC-CW	Side Clasp Roll Bar 2"	Counter weight for short curtains to maintain even roll up.
23-SC-TUBE	Side Clasp Roll Bar 2"	Tube for roll to peak light dep system to maintain straight roll up.



Steel Tube

ID NO.	TUBE DIAMETER	TUBE LENGTH	SWEGED	GAUGE
73-ST1.25-144-16	1.25"	12'	No	16
73-ST1.5-144-16	1.5"	12'	No	16
73-ST1.5-147-16S	1.5"	12'	Yes	16
73-ST1.5-96-16S	1.5"	8'	Yes	16
73-ST2-147-16S	2"	12'	Yes	16

Flare Tube & Flare Angle

72-FT



Flare Tube 1.5" x 1.75" rectangular tube made from special aluminum alloy. Will not rust, crack, warp, or peel.

SIZES				
8'	10'	12'	14'	16'
SOLD				
Each				

72-FTA



1.5" x 1.75" Flare Angle.

SIZES	
8'	12'
SOLD	
Each	

25-FT2



The Flare Tool cuts and shapes the angle you need for creative framing.

Flare Tube End Wall:

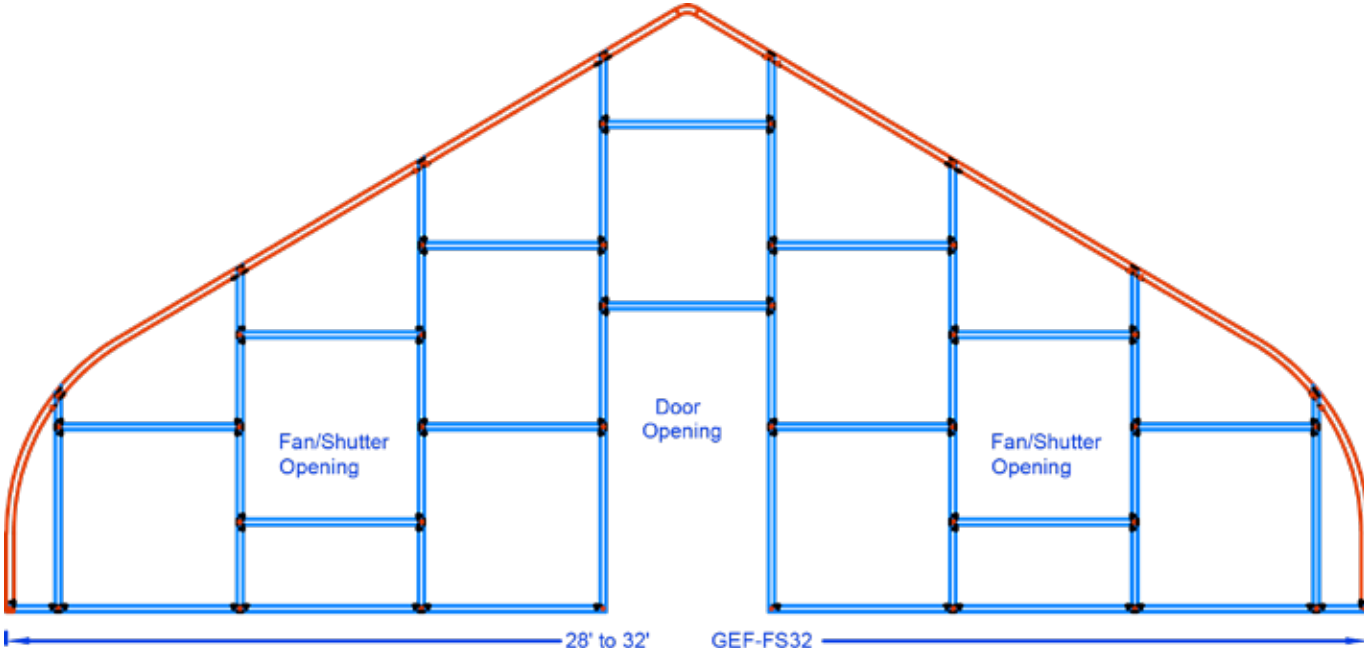

Keder

KEDER Curtain System

For a flat and flush curtain that is easy to install and maintain.

- Fabric cable hem slides into Keder groove
- No wire and wire lock channel
- Ideal for curtain wall applications

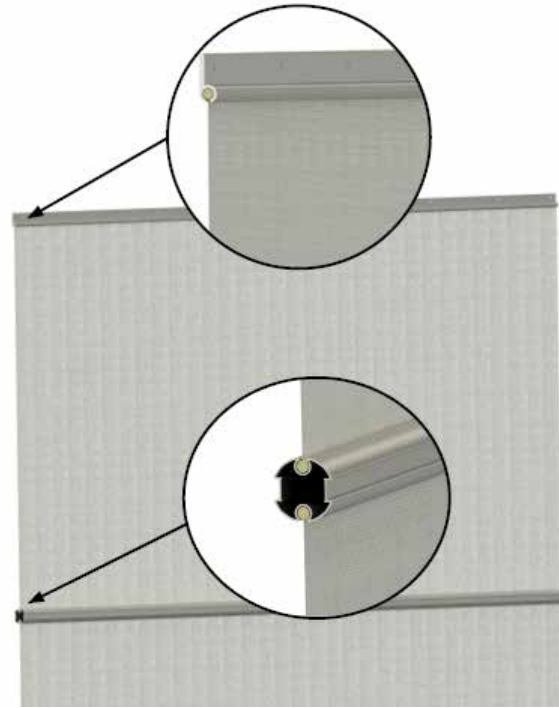

72-KEDER-TC



Keder Top Clasp. 12' long aluminum with .25" holes punched every 12" on center.

72-KEDER12



Keder Double bar. 2" outside diameter. 12' long with double Keder rope grooves. Includes splice and four tek screws.

72-KEDER-S



Keder Single bar. 1.375" outside diameter. 12' long with single Keder rope groove. Includes splice and four tek screws.

Fabrics and Inflation components



Solarside lightweight, diffusing, woven curtain poly

ITEM CODE	TYPE	OZ SQ/YD	MIL	WIDTH
24-FRSS6	Curtain Fabric	4.1	9	6'
24-FRSS8	Curtain Fabric	4.1	9	8'
24-FRSS13	Curtain Fabric	4.1	9	13'

Frosted durable, semi-transparent, diffusing vinyl

ITEM CODE	TYPE	OZ SQ/YD	MIL	WIDTH
24-FRFV9.5	Frosted	9.5	12	Custom
24-FRFV9.5-6	Frosted	9.5	12	6'
24-FRFV13	Frosted	13	17	Custom
24-FRFV18	Frosted	18	20	Custom
24-FRWW9.5	White	9.5	12	Custom
24-FRWW18	White	18	20	Custom

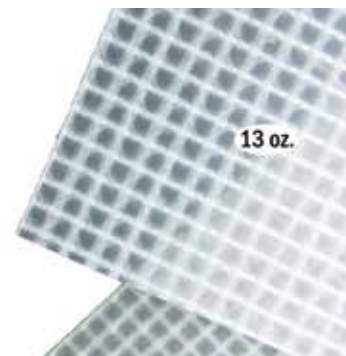

Blackout vinyl

ITEM CODE	TYPE	OZ SQ/YD	MIL	WIDTH
24-BOV9.5	Blackout	9.5	9	Custom
24-BOV9.5-6	Blackout	9.5	9	6'
24-BOV16	Blackout	16	12	Custom

Inflation Components & Kits



ITEM CODE	CFM	KIT	POWER
22-IF60	60	No	120V
22-IF60-A	60	Yes	120V
22-IF60-SW	60	Yes	120V
22-IF60-MB	Mounting bracket		
22-IF148	148	No	120V
22-IF148-A	148	Yes	120V
22-IF148-MB	Mounting bracket		
22-IF80-R-12V	80	Yes	Solar
22-IF80-SW-12V	80	Yes	Solar

Jumper Hoses		
22-IFJH		
SIZES		
24"	48"	72"

Visit www.advancingalternatives.com for pricing information.

Wire Products

21-ZZW

Our Zig Zag Wire is made from .085" diameter, heavy-duty, stainless steel spring wire, double-tempered to allow for a better return to original shape.



ITEM CODE	THICKNESS	LENGTH	QTY
21-ZZW4	.085 SS	4'	Ea
21-ZZW4-20	.085 SS	4'	20
21-ZZW4-50	.085 SS	4'	50
21-ZZW6	.085 SS	6'	Ea
21-ZZW6-50	.085 SS	6'	50

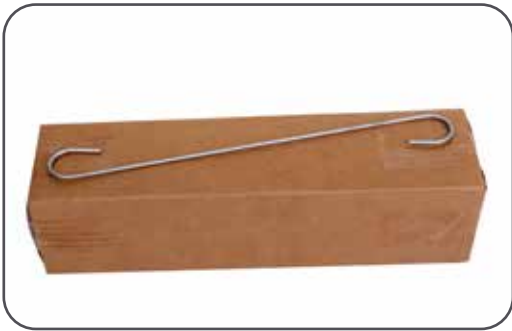

21-SH

S-Hooks made from galvanized 10 gauge heavy steel wire.

S HOOK LENGTH (INCHES)								
6	12	15	18	24	30	36	42	48
SOLD					QTY PER BOX			
Box					100			

Sod Staples

ITEM CODE	GAUGE	LENGTH	WIDTH	BOX QTY.
21-SS-10PK	11	6"	1"	10
21-SS-25PK	11	6"	1"	25
21-SS100PK	11	6"	1"	100
21-SS-6-1-11	11	6"	1"	1000
21-SS-6-1-8	8	6"	1"	500
21-SS-8-1-11	11	8"	1"	1000
21-SS-8-1-8	8	8"	1"	500



Row Cover Hoops

ITEM CODE	DIAMETER	RADIUS*	TENSILE	PRE-BENT	BOX QTY.
21-RCH64	.177"	17"	150,000	64"	100
21-RCH64B	.177"	17"	150,000	64"	3000
21-RCH76	.177"	17"	150,000	76"	100

*Radius before ground installation



Visit www.advancingalternatives.com for pricing information.

Wind Control

We will package your wind control based on your ventilation opening.

- Light Wind (LW) inverted V pattern
- Heavy Duty (HD) continuous X pattern
- From 24' to 300'



ITEM CODE	MAX HEIGHT	ROPE PATTERN	EZ SNAP	EYE BOLTS
85-LW-EZEB6-	8'	V	Yes	6"
85-LW-EZEB8-	8'	V	Yes	8"
85-HD-EZEB6-	8'	X	Yes	6"
85-HD-EZEB8-	8'	X	Yes	8"

LENGTH IN FEET																						
24	32	40	48	56	64	72	80	88	96	104	112	120	128	136	144	152	160	168	176	184	192	200

Wind Rope

- Polyester
- 1/4" knitted cord
- Convenient spool sizes

ITEM CODE	SPOOL LENGTH
85-WR.25-125	125'
85-WR.25-250	250'
85-WR.25-500	500'
85-WR.25-1000	1000'



Webbing Material

Various widths and lengths for your wind control needs.

ITEM CODE	WIDTH	LENGTH	COLOR	STRENGTH
85-WP-2	2"	Per FT	Dark	5200
85-WP-2-300	2"	300'	Dark	5200
85-WP-2.2W	2.25"	LF	White	1750
85-WP-2.2W1100	2.25"	1100'	White	1750
85-WP-2B	1.75"	LF	Black	2000
85-WP-2B300	1.75"	300'	Black	2000
85-WP-2W	2"	LF	White	5000
85-WP-2W300	2"	300'	White	5200



Visit www.advancingalternatives.com for pricing information.

Wind Control Components

EZ Snaps



EZ Snap Hooks

- Aluminum.
- Fits into your wire lock extrusions without being fastened in.

ITEM CODE	QTY PER PACK
85-EZSNAP	Ea.
85-EZSNAP25	25ct
85-EZSNAP500	500ct

EYE BOLTS

ITEM CODE	LENGTH	INCLUDES NUTS (2) AND WASHERS (2)	DIAMETER	THREADS PER INCH	OPEN EYE
36-EB2	2"	No	1/4"	20	No
36-EB2A	2"	Yes	1/4"	20	No
36-EB4	4"	No	5/16"	18	No
36-EB4A	4"	Yes	5/16"	18	No
36-EB4O	4"	No	5/16"	18	Yes
36-EB4OA	4"	Yes	5/16"	18	Yes
36-EB6	6"	No	3/8"	16	No
36-EB6A	6"	Yes	3/8"	16	No
36-EB6O	6"	No	3/8"	16	Yes
36-EB6OA	6"	Yes	3/8"	16	Yes
36-EB8	8"	No	3/8"	16	No
36-EB8A	8"	Yes	3/8"	16	No

Lashing Winch

85-LWA

Used with our 5000lb test webbing, this lashing winch creates a wind control system unlike most rope systems on the market. Most often used for wind control on external light dep systems, vertical curtain walls, and single layer poly houses.

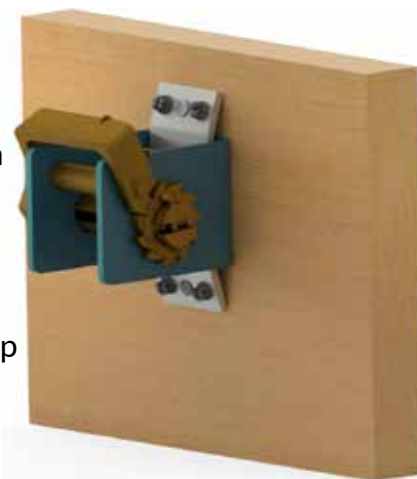

EYE SCREWS

ITEM CODE	LENGTH	OPEN EYE
36-ES.187-1.5	1.5"	No
36-ES.25-2.187	2 3/16"	No
36-ES.312-4	4"	No
36-ES.312-6	6"	No
36-ES.375-5	5"	No
36-ES.375-6	6"	No
36-ES.375-8	8"	No
36-ESH.25-3.5	3.5"	Yes
36-ESH.312-3.5	3.5"	Yes

Fans



Shutters

ITEM CODE	DESCRIPTION
86-S16	16" single panel shutter
86-S24	24" single panel shutter
86-S30	30" single panel shutter
86-S36	36" single panel shutter
86-S40	40" double panel shutter
86-S42	42" double panel shutter
86-S48	48" double panel shutter
86-S54	54" double panel shutter
86-S60	60" double panel shutter

Circulation Fans

ITEM CODE	DESCRIPTION
86-HAF-EB20	20" EZ-Breeze 1680 CFM single phase fan.
86-HAF-GB12	12" Green Breeze 970 CFM single phase fan.
86-HAF-GB20	20" Green Breeze 3650 CFM single phase fan.



These fans come with a 10' cord and are pre-wired for 115V.

Shutter & Slantwall Fans



ITEM CODE	DESCRIPTION
86-SF12	12" shutter fan. 970 CFM 1625RPM
86-SF16	16" shutter fan. 1440 CFM 1625 RPM
86-SF20	20" shutter fan. 3140 CFM 1725 RPM
86-SF24	24" shutter fan. 4640 CFM 1725 RPM
86-SF30	30" shutter fan. 6770 CFM 825 RPM
86-SWF30	30" slant wall fan. 7100 CFM 825 RPM
86-SWF36	36" slant wall fan. 9700 CFM 825 RPM
86-SWF50	50" slant wall fan. 21600 CFM 588 RPM

Shutter Motor Kit

86-SMK Our shutter motor kit works with our single or double panel shutters. Kit includes motor, lever arm, chain, s hooks, tension springs, mounting bracket and assembly hardware.



Fans & Heaters

Heaters

Modine Model PTP

Stainless steel heat exchangers for longer life. 80% efficiency. Modine's horizontal power vented PTP unit heater line. Electronic ignition with 100% shutoff and continuous retry. Power vent does not require vertical vent pipe.



ITEM CODE	BTU/HR INPUT/OUTPUT	CFM	VENT SIZE	WEIGHT	FUEL SOURCE
86-MPTP150	150,000/120,000	2140	4"	165lbs	Propane OR Natural Gas
86-MPTP175	175,000/140,000	2725	4"	210lbs	Propane OR Natural Gas
86-MPTP200	200,000/160,000	2870	4"	220lbs	Propane OR Natural Gas
86-MPTP250	250,000/200,000	3995	6"	265lbs	Propane OR Natural Gas
86-MTPT300	300,000/240,000	4545	6"	270lbs	Propane OR Natural Gas

Modine Model PDP

80% efficiency. Modine's vertical power vented PDP unit heater line. Electronic ignition with 100% shutoff and continuous retry. Power vent does not require vertical vent pipe.



ITEM CODE	BTU/HR INPUT/OUTPUT	CFM	VENT SIZE	WEIGHT	FUEL SOURCE
86-MPDP150	150,000/120,000	2180	5"	168lbs	Propane OR Natural Gas
86-MPDP175	175,000/140,000	2550	5"	175lbs	Propane OR Natural Gas
86-MPDP200	200,000/160,000	2870	5"	239lbs	Propane OR Natural Gas
86-MPDP250	250,000/200,000	3700	6"	239lbs	Propane OR Natural Gas

Modine Efinity93

Modine model PTC. With stainless steel heat exchangers for longer life. At 93% efficiency, this is Modine's most efficient condensing unit heater in North America. Direct spark ignition. Power exhaust. High efficiency separated combustion.



ITEM CODE	BTU/HR INPUT/OUTPUT	CFM	VENT SIZE	WEIGHT	FUEL SOURCE
86-MPDP150	150,000/120,000	2180	5"	168lbs	Propane OR Natural Gas
86-MPDP175	175,000/140,000	2550	5"	175lbs	Propane OR Natural Gas
86-MPDP200	200,000/160,000	2870	5"	239lbs	Propane OR Natural Gas
86-MPDP250	250,000/200,000	3700	6"	239lbs	Propane OR Natural Gas

Modine Hot Dawg

Electric ignition with 100% shutoff and continuous retry. Power vent does not require vertical vent. 80% efficiency.



ITEM CODE	BTU/HR INPUT/OUTPUT	CFM	VENT SIZE	WEIGHT	FUEL SOURCE
86-MHD45	45,000/36,000	720	3"	60lbs	Propane OR Natural Gas
86-MHD75	75,000/60,000	1160	3"	85lbs	Propane OR Natural Gas
86-MHD100	100,000/80,000	1490	4"	125lbs	Propane OR Natural Gas
86-MHD125	125,000/100,000	1980	4"	128lbs	Propane OR Natural Gas

Visit www.advancingalternatives.com for pricing information.

Fasteners

TEK SCREWS

ITEM CODE	#	LENGTH	WASHER	QTY PER PACK
34-TS12-.75-110	12	.75"	Washer Head	110
34-TS12-.75-1000	12	.75"	Washer Head	1000
34-TS12-1-110	12	1"	Washer Head	110
34-TS12-1-1000	12	1"	Washer Head	1000
34-TS12-1.5-110	12	1.5"	Washer Head	110
34-TS12-1.5-1000	12	1.5"	Washer Head	1000
34-TS14-1-110	14	1"	Washer Head	110
34-TS14-1-1000	14	1"	Washer Head	1000
34-TS14-1.5-110	14	1.5"	Washer Head	110
34-TS14-1.5-1000	14	1.5"	Washer Head	1000
34-TS14-2-110	14	2"	Washer Head	110
34-TS14-2-1000	14	2"	Washer Head	1000
34-TS14-2.5-110	14	2.5"	Washer Head	110
34-TS14-2.5-1000	14	2.5"	Washer Head	1000
34-TSNB12-1.5	12	1.5"	Neo Bonded	100
34-TSNB12-2	12	2"	Neo Bonded	100
34-TSNB14-1.5	14	1.5"	Neo Bonded	100
34-TSNB14-1.75	14	1.75"	Neo Bonded	100
34-TSNB14-2	14	2"	Neo Bonded	100

WOOD GRIP TEK SCREWS

34-WG12-1.5-110	12	1.5"	Washer Head	110
34-WG12-1.5-1000	12	1.5"	Washer Head	1000
34-WG14-1.75-65	14	1.75"	Washer Head	65
34-WG14-1.75-110	14	1.75"	Washer Head	110
34-WG14-1.75-1000	14	1.75"	Washer Head	1000



U-CLAMPS

ITEM CODE	USED ON
35-UC1.25-1ST	1.25" Square Tube
35-UC2-1	1.05" O.D.
35-UC2-1.3	1.315" O.D.
35-UC2-1.3HD	1.315" O.D. Heavy Duty
35-UC2-1.5ST	1.5" Square Tube
35-UC2-1.6	1.66" O.D.
35-UC2-1.6-HD	1.66" O.D. Heavy Duty
35-UC2-1.9	1.9" O.D.
35-UC2-1.9-HD	1.9" O.D. Heavy Duty
35-UC2-2.3	2.36" O.D.
35-UC2-2.3-HD	2.36" O.D. Heavy Duty
35-UC2-2.8-HD	2.875" O.D. Heavy Duty
35-UC2H-2.3EB	2.36" O.D.
35-UC4H-2.3BB	2.36" O.D.



STRAPPING CLAMPS

ID NO.	CONNECTS 1.315" PIPE TO
35-SC1.3-1.3	1.315"
35-SC1.3-1.6	1.66"
35-SC1.3-2	2"
35-SC1.3-2.3	2.3"



LAG SCREWS

ITEM CODE	LENGTH
34-LS.312-1.75	1.75"
34-LS.375-1.25	1.25"
34-LS.375-1.75	1.75"
34-LS.375-3	3"



NEO BONDED WASHERS

ITEM CODE	NUMBER	SIZE
33-WNB12-.625	12	.625" OD
33-WNB12-1.125	12	1.125" OD
33-WNB14-.625	14	.625" OD
33-WNB14-1.125	14	1.125" OD



Hardware Goods

Pruners & Hand Tools



10-K0050

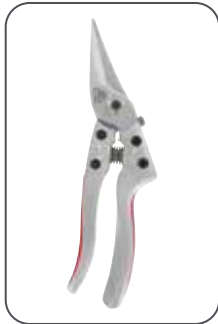

10-K0060



10-K0400



10-K0500



10-K0600



10-959145

ITEM CODE	DESCRIPTION	MAX JAW CAPACITY	SOLD	QTY PER CASE
10-K0035	Harvesting Pruners, Light Duty	.5"	Ea./Case	20
10-K0040	Trimmer, Light Duty	.5"	Ea./Case	20
10-K0050	Silver Line Inox Spring Pruner	.75"	Ea./Case	6
10-K0060	Silver Line Inox Spring Trimmer	.75"	Ea./Case	6
10-K0400	Medium Ergonomic Pruner	.75"	Ea./Case	6
10-K0500	Traditional Style Pruner	1"	Ea./Case	6
10-K0550	Anvil Pruner	1"	Ea./Case	6
10-K0600	Large Ergonomic Pruner	1"	Ea./Case	6
10-K0650	Revolving Handle Pruner	1"	Ea./Case	6
10-K0700	Left Hand Ergonomic Pruner	1"	Ea./Case	6
10-959145	Fitted leather holster with belt clip	N/A	Ea./Case	6



Metallo Pruners

Metallo is a company from the Netherlands providing quality hand pruners and other horticulture tools.

Their pruners are made with high-carbon chrome-plated blades to hold their edge and sharpness. Their lightweight aluminum bodies and comfortable grips in varying sizes will accommodate just about any size hand.



Folding Saws

High carbon chrome plated steel blade with hardened teeth. Blade length 7", folded length 9.5", opened length 16.4".

STRAIGHT BLADE	CURVED BLADE
10-K6025	10-K6045



Loppers

Various sizes of loppers will mean you can find the right size for your job. From 15.6" in length up to 27.6", we have what you need!

Visit us online at www.advancingalternatives.com to see our full-line of pruners, saws, loppers, trimmers, gloves, sprayers, and more!

*All Metallo tools have replacement blades available
Visit www.advancingalternatives.com for pricing information.

Sprayers



Kwazar®

Kwazar delivers the quality you've come to expect from Europe's horticulture sector. From your home garden to your greenhouse business, Kwazar sprayers have you covered. From .5L to 15L backpack sprayers they have the size you need.



ITEM CODE	MODEL	LITERS	STYLE
12-KSM.5	Mercury	.5	Trigger Sprayer
12-KSM1	Mercury	1	Trigger Sprayer
12-KSV1	Venus	1	Hand Pump
12-KSV1.5	Venus	1.5	Hand Pump
12-KSV2	Venus	2	Hand Pump
12-KSO3	Orion	3	Knapsack
12-KSO6	Orion	6	Knapsack
12-KSO9	Orion	9	Knapsack
12-KSO12	Orion	12	Knapsack
12-KSN15	Neptune	15	Backpack
12-KSN15E	Neptune	15	Electric Backpack



Kwazar offers a variety of wand attachments for Orion and Neptune models. To learn more contact us at: sales@advancingalternatives.com

Hardware Goods

Gloves



*Luminus style shown above



A hand protection solution for all your gardening and outdoor work needs. Our line of MICROFINISH® coated gloves include styles appropriate for durable work, a sensitive touch, and even tiny, backyard helpers! Plus, the gloves come in a variety of colors and designs.



STYLE	COLORS	MATERIAL	SIZES	GUAGE	SOLD
Flora	Pink, Aqua, Yellow, Orange	Latex	S - M	13	Ea / Case
Garden	Burgundy, Navy, Green, Violet	Nitrile	S - L	13	Ea / Case
Active Grip	Black, Orange, Neon	Nitrile	XS - XXL	13	Ea / Case
Luminus	Rose, Herb	Nitrile	S - L	13	Ea / Case
Kids	Pink, Aqua, Burgundy, Navy, Green	Latex	XXXS - XS	13	Ea / Case
Landscape	Green, Brown, Gray	Nitrile	XS - XXL	10	Ea / Case
Thermal	Black, Orange, Grey, Neon	Latex	XS - XXL	10	Ea / Case



Visit www.advancingalternatives.com for pricing information.



ADVANCING
ALTERNATIVES

Advancing Alternatives
501 Richardson Drive,
Suite 600
Lancaster Pennsylvania, 17603
Phone: 877-546-2257
E-mail: sales@advancingalternatives.com
Website: www.advancingalternatives.com