

PROVIDING QUALITY, VALUE & INNOVATION SINCE 1967

PANACEA®

PATIO & GARDEN



URBAN
GARDENER®

Introducing our
ECO-FRIENDLY EUCALYPTUS
RAISED GARDEN PLANTER – pg. 4

FULL LINE CATALOG
2023/2024

**2023 / 2024 Lawn & Garden
Full-Line Catalog**

Panacea Products Corporation is a leading manufacturer of wire products in the Lawn & Garden, Fireplace, Floral & Craft and Home Organization categories.

Our products are available wholesale only to order through multiple distributors, resellers, growers or by contacting your Panacea representative. If you are in the Columbus, Ohio or Antioch, IL area we would like to extend a warm invitation for you to visit our facility (by appointment please) to see our manufacturing, assembly and distribution operations, as well as see our private showroom. Please see contact details on the back of this catalog.

Whether you are a large or small reseller, your business is important to us. While our business has grown, our staff has remained relatively small and we remain committed to servicing your needs with personal attention that shows how much we appreciate your business. Thank you for over fifty wonderful years together!



New Product Highlights!

Scan here with your smartphone camera to view our 2022 / 2023 L&G New Product Video. You may also find this by navigating to the web address below:

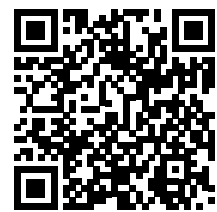

**PanaceaProducts.com
/NewGarden22**

TABLE OF CONTENTS

<i>Category</i>	<i>Page #</i>
Raised Bed Gardening	4-17
Outdoor Entertaining & Décor	18-19
Planters – Metal	20-25
Planters – Metal Wall	26-29
Planters – Novelty / Retro / Industrial	30-31
Planters – Modern Farmhouse Metal & Wire	32-33
Hanging Baskets	34-38
Hanging Basket Stands	39
Planters – Floor, Window & Deck	40-45
Terrariums & Succulent Planters	46-48
Pot Toppers & Natural Accents	49
Coco Liners	50-51
Grow Bags	52-53
Plant Stands & Accessory Furniture	54-65
Plant Caddies	66-69
Shepherd Hooks	70-75
Deck Hooks & Flower Box Brackets	76-77
Brackets	78-80
Wall Decor	81
Birding	82-85
Arbors	86-87
Fence - Border, Sectionsl, Roll, & Folding	88-101
Trellises – Metal	102 -112
Pot Trellises – Metal	113
Trellises - Specialty Metal	114-115
Trellises - Wood	116-117
Garden Obelisks	118-119
Hose Storage	120-121
Watering Cans	122-123
Green Houses	124-125
Plant Supports - Rustic & Modern	126-127
Plant Supports - Accessories	128-131
Plant Support – Stakes & Gathering Rings	132-133
Plant Supports – Tower Plant Supports	134
Plant Supports – A Frames & Inverted Cages	135
Plant Support – Tomato Cages	136-139
Displays	140-147



Deluxe Cedar Elevated Garden Planter, pg. 7

**URBAN
GARDENER**



Modern Farmhouse Plant Supports pg. 127

**MODERN
FARMHOUSE
Gardener**



Modern Farmhouse Plant Stands pg. 60

**MODERN FARMHOUSE
HOME & GARDEN**



Modern Farmhouse Contemporary Wood Trellis pg. 117



Modern Farmhouse Border Edge Fence pg. 94



Modern Farmhouse Planters pg. 33
Watering Can & Mister pg. 123



Includes Retractable Workspace!

Ultimate
RENEWABLE
— EUCALYPTUS —

4-Panel Expandable Plant Support
Kit | 83830
(and other raised bed
supports on pg. 11)



Why Is Eucalyptus Sustainable?

Eucalyptus is an extremely sustainable and renewable resource. Eucalyptus is a plantation-grown hardwood that is sustainably harvested and in plentiful supply. Some plantations can produce up to 30 times more volume per year than your average carpentry wood bearing trees.



This high-quality, kiln-dried timber is incredibly solid with great durability and strength and has beautiful grain and a smooth finish that requires minimal maintenance. Eucalyptus is extremely dense, rot- and decay-resistant with a high oil content that repels water and moisture making it ideal for outdoor furniture and planters. It also weathers to a soft gray if left untreated, however, it can be stained to maintain its rich tones.

Eco-friendly Eucalyptus
Raised Garden

With retractable workspace and casters.

81485 / 1 per case

Product Dimensions:
47 in. W x 21 in. D (29" with work shelf) x 36 in. H

Planting Area:
45.5 in. W x 20 in. D x 12 in. H

Holds 3 cu. ft. of soil

- Locking, heavy duty casters provide flexibility to move planter to sunny locations.
- Great for small spaces - townhouses, condos & apartments
- 36" gardening height reduces back fatigue
- No Rust aluminum frame
- Includes soil liner



Looks Like High Quality Teak Wood But Less Expensive & Retains Color Longer!



Galvanized & Cedar

Great for small spaces - townhouses, condos, apartments, balcony or backyard gardening

Fashionable, rustic galvanized steel

Durable, insect-resistant cedar

Includes soil liner

Galvanized & Cedar Elevated Garden Planter

With soil liner.

81478 / 1 per case

Product Dimensions:
48 in. W x 32.73 in. H x 23 in. D

Planting Area:
45.75 in. W x 8.25 in. H x 19.75 in. D

Holds approx. 5 cu. ft. of soil

Cedar & Aluminum

Integrated metal grid trellis for plant support

No rust aluminum frame

Durable, insect-resistant cedar

Includes shelf for convenient storage

Locking wheels provide flexibility to move planter to sunny locations

Includes soil liner

Deluxe Cedar Elevated Garden Planter

With steel trellis, rust-proof frame and soil liner.

81483 / 1 per case

Product Dimensions:
40.125 in. W x 33.5 in. H x 18 in. D (Trellis height 62.73 in.)

Planting Area:
37.5 in. W x 12.5 in. H x 15.25 in. D

Holds approx. 3.25 cu. ft. of soil



No Rust Aluminum Frames



Galvanized & Cedar Ground Garden Planter

With soil liner.

81738 / 1 per case

Product Dimensions:
39.75 in W x 30 in H x 18.2 in D

Planting Area:
37.25 in W x 12.5 in H x 15.5 in D

Holds approx. 4 cu. ft. of soil



Combines privacy, vertical gardening and a trellis for vining plants!

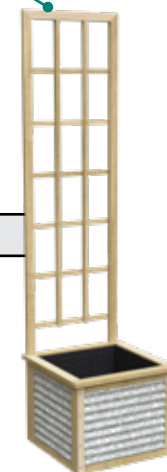

Galvanized & Cedar Square Planter Box

With trellis and soil liner.

81469 / 1 per case

Product Dimensions:
19.5 in W x 76 in H x 20 in D

Planting Area:
16.25 in W x 14.75 in H x 16.5 in D

Holds approx. 2.25 cu. ft. of soil



Great for small spaces!

Townhouses, condos, & apartments

Cedar & Aluminum Floor Planter

With trellis, casters & soil liner.

81457 / 1 per case

Product Dimensions:
39.5 in. W x 20.5 in. H x 13.5 in. D (Trellis height 62.73 in.)

Planting Area:
38 in. W x 17.5 in. H x 12.25 in. D

Holds approx. 4.5 cu. ft. of soil

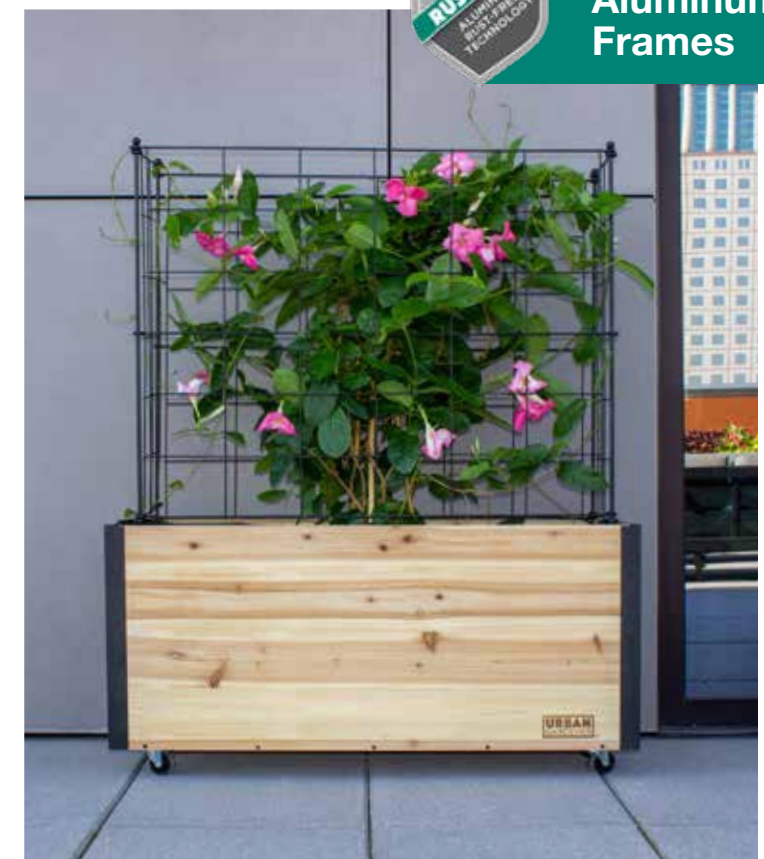



Premium, Furniture-Quality Cedar Garden Accessories

With Partially Assembled
Panels For Easy Assembly.



Distinctive
Hardware & Details



Mission Cedar Over-the-Rail Planter

With adaptable spacer and soil liner.

81722 / 1 per case

Product Dimensions:

30 in. W x 12 in. H x 12.75 in. D

Planting Area:

25.3 in. W x 8.7 in. H x 8.25 in. D

Over-the-rail planter
adapts to a 4" or
6" wide railing with
removable spacer

WOODLINK®

GARDEN COLLECTION

Our Woodlink brand uses the finest cedar and state-of-the-art equipment to create products that surpass the quality of any similar wood items in the industry. Careful attention is given to each piece with additional sanding and inspection to ensure they meet our rigid standards. Unlike other wood products, we never glue or staple, each piece is predrilled and assembled using rugged zinc screws.

We are pleased to introduce this new, premium collection of garden décor with impeccable quality. Additionally, we've taken the most popular trend in new homebuilding, Craftsman or Mission-styling, and added details to create this furniture-quality collection of outdoor products as part of our new Mission Collection product line.

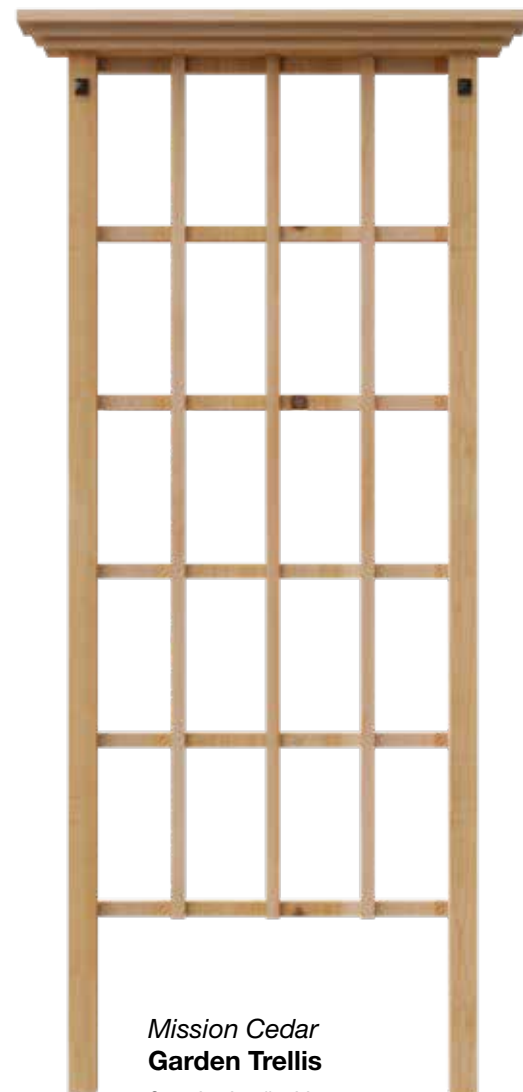

Mission Cedar Garden Trellis

Oversized 36" wide.

81724 / 2 per case

Product Dimensions:

36 in. W x 84 in. H

Promotional Cedar Stand-Up Raised Garden Planter

A Rugged, Cedar Elevated Garden Planter That's Promotionally Priced!



Holds 8 cubic
feet of soil

Convenient
storage shelf

Counter Sunk Holes for
easy assembly and clean
appearance

Promotional Cedar Stand-Up Planter

Includes soil liner.

83356 / Natural Cedar / 1 per case

Product Dimensions:

47.5 in. W x 33 in. H x 22 in. D

Planting Area:

46 in. W x 9.5 in. H x 20 in. D

Holds 8 cu. ft. of soil

- Includes quality virgin cedar wood
- Pre-drilled for easy set-up
- Rugged, zinc-coated hardware
- Generous planting capacity



Colorful Packaging

Featuring
benefits & simple
instructions with
soil volume.



Includes Soil Liner



RAISED GARDEN BED ACCESSORIES

Raised Garden 4-Panel Expandable Plant Support Kit

Folds compactly for seasonal storage. Includes 2 plant supports, 20" H 83830 - Black, 12 per case



Both the 83830 & 83831 include full-color labels for impactful merchandising

Raised Garden A-Frame Trellis

12" W x 39.5" H 83831 - Black / 6 per case



Perfect for Cucumbers! Folds compactly for seasonal storage!



Cedar 3-Tiered Stair Step Garden Bed

Natural cedar.

82203 / 1 per case

Product Dimensions:

48 in. W x 22 in. H x 48 in. D

Planting Area:

37.5 in. W x 12.5 in. H x 15.25 in. D

Holds 18.3 cu. ft. of soil

- Terrace design for both shallow and deep root systems
- Generous, yet compact - over four square feet of planting space
- Ideal for balcony or backyard gardening
- Durable, insect-resistant cedar



Raised Bed Brackets

Heavy-duty, powder coated steel raised garden brackets. Set of 4 brackets boxed in an attractive color box. Great option for those who need custom shapes & sizes!



Heavy Duty Steel Raised Bed Brackets

4-piece boxed set.

89584 / Black / 4 per case

Product Dimensions: 6.5 in. W x 12 in. H x 6.5 in. D

EASILY CREATE A RAISED BED USING STANDARD LUMBER

Customize the shape & size of your raised bed!

L-SHAPE



RECTANGLE



MULTI-TIER





Introducing the Best Metal, Raised Garden Planters *Ever!*



Available in Ground or Stand-Up Version

BOTH VERSIONS INCLUDE:

- **Fast & Easy Set-Up - No Tools!**
- **Generous Yet Compact Planting Area**
Perfect for small patios (apartments, condos, and townhouses)
- **Compact Storage**
Stores flat for seasonal storage
- **Rugged Steel Construction**
Pre-galvanized & powder coated to prevent rust.



Pre-Galvanized Powder-Coated Steel



No Tools Assembly for Quick Set-Up

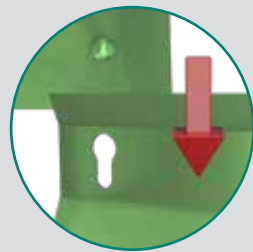

Patent-Pending Key-Hole Locking Mechanism



Includes Soil Liner

No Tools Raised Garden Planters

Includes Patent Pending No-Tools Easy Assembly



1 Ground Version

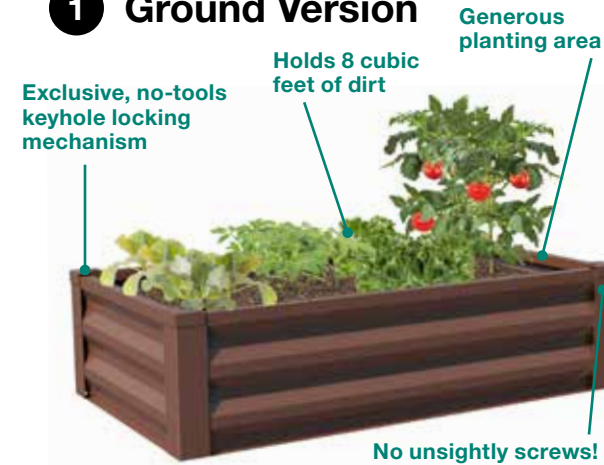

COLORFUL PACKAGING!

Full color box featuring planting benefits and simple instructions.



Urban Gardener Raised Garden Planter

Includes soil liner.

83393 / Timber Brown / 2 per case

83394 / Forest Green / 2 per case

83395 / Eggplant / 2 per case

83396 / Antique Iron / 2 per case

Product Dimensions:
47 in. W x 12 in. H x 26 in.

Holds 8 cu. ft. of soil

Planting Area:
46.8 in. W x 11.8 in. H x 25.8 in. D

2 Stand-Up Version

Comfortable 30.5" gardening height reduces back fatigue

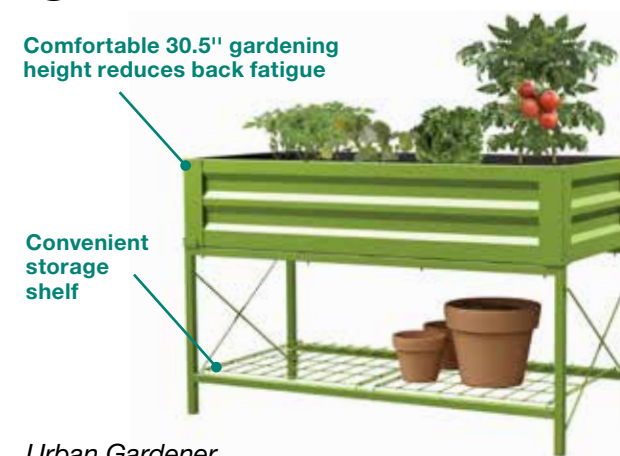

Urban Gardener Stand-Up Raised Garden Planter

Includes soil liner.

83360 / Moss Green / 1 per case

83361 / Timber Brown / 1 per case

Product Dimensions:
47 in. W x 30 in. H x 24 in. D

Holds 6 cu. ft. of soil

Planting Area:
46.8 in. W x 9.8 in. H x 23.8 in. D

Promotional Options:

Two Sizes, Colors Lower Price Points!

We've cut some material costs (No Liner) & weight to offer an alternative size & lower promotional price point for our popular "No Tools" raised metal gardens. Other custom colors/sizes available in high volume.

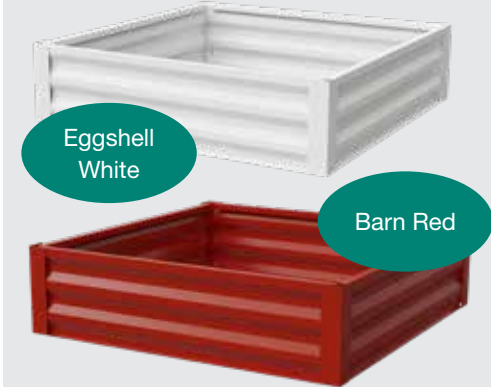

Urban Gardener PROMOTIONAL Raised Garden Planter

83362 / Eggshell White / 1 per case

Product Dimensions:
36 in. W x 10 in. H x 36 in. D

Planting Area:
35.8 in. W x 9.8 in. H x 35.8 in. D

83363 / Barn Red / 1 per case

Product Dimensions:
48 in. W x 10 in. H x 48 in. D

Planting Area:
47.2 in. W x 9.8 in. H x 47.8 in. D

FLEXIBLE MERCHANDISING PROGRAM

Urban Gardener Metal Raised Garden Display

Includes soil liner.

90-90323EM / EMPTY

Display Dimensions:
48 in. W x 12 in. H x 27 in. D

Holds up to 16 selling units and takes only minutes to set-up. No tools needed! Mix & match colors and/or ground & stand-up versions.

Rack available to support raised bed accessories upon request. (see 83830 & 83831 on pg. 11)





Vintage Raised Garden Planters

The look is fashionable and the construction is rugged. All you need is a pair of pliers and a screwdriver to connect the trendy, aged galvanized panels together!

These good looking, raised bed planters look like popular, galvanized animal watering troughs, but they are actually flat embossed sheet metal panels that easily bolt together or store flat for seasonal storage.



Attractive packaging fits easily into a car.

Compact Planters

Great For Small Spaces - Townhouses, Condos And Apartments.

Modern Farmhouse Elevated Garden Planter

With casters & storage shelf.

81439 / Matte Black
1 per case

81487 / Milkhouse White
1 per case

Product Dimensions:
30 in W x 36 in H x 16 in D

Planting Area:
30 in W x 12 in H x 15 in D

Holds 3.1 cu. ft. of soil

36" Height reduces back fatigue

Holds 3.1 cubic feet of soil

Includes storage shelf for potting tools

Wheels provide flexibility to move planter to sunny locations.



MODERN FARMHOUSE
HOME & GARDEN

Packaged in individual Urban Gardener® brand color boxes



Vintage Stand Up Garden Planter with Stand

With rust finish stand.

83479 / 1 per case

Product Dimensions:
41.5 in W x 36 in H x 23.25 in D

Planting Area:
41 in W x 22 in H x 23 in D

Holds 7 cu. ft. of soil

Vintage Square Raised Garden Planter

Taller, 18 inch height for deeper planting.

83476 / 1 per case

Product Dimensions:
22 in W x 18 in H x 22 in D

Holds 5 cu. ft. of soil



Vintage Rectangle Raised Garden Planter

Taller, 18 inch height for deeper planting.

83475 / 1 per case

Product Dimensions:
40 in W x 18 in H x 22 in D

Holds 9 cu. ft. of soil



Mini Garden-in-a-Tub Planters

Our Mini Rectangle "Garden-In-A-Tub" Are Now Available In 3 Finishes:



Galvanized

Milkhouse White

Matte black with copper handles

Mini Rectangle Planter

With removable drain plugs.

81607 / Galvanized / 4 per case

81639 / Milkhouse White / 4 per case

81442 / Matte Black / 4 per case

Product Dimensions:
24 in W x 10 in H x 16 in D

Holds 1.82 cu. ft. of soil



Shipped in colorful display 4 pack tray



Raised Garden - Metal | 15

Dual Purpose Compact Elevated Planters...

...Or Beverage Tubs For Outdoor Entertaining!

Fun *and* Functional!



Holds Cold Drinks Or Use As A Planter!



Enamelware Inspired Beverage Tub & Planter

With matching metal stand.

82630 / White Enamel Finish / 1 per case

Product Dimensions:
18 in W x 33 in H x 18 in D

Planting Area:
18 in W x 12 in H x 18 in D

Holds 2.25 cu. ft. of soil

Nostalgic Washtubs are the inspiration for these dual-purpose garden planters and beverage tubs. Each includes removable drain plug and contrasting handles. Galvanized version includes bottle opener, and vintage graphics.



Includes built-in Bottle Opener



Packaged in an attractive color box

Vintage Galvanized Washtub / Beverage Stand

With bottle opener.

86796 / 1 per case

Product Dimensions:
18 in W x 32 in H x 18 in D

Planting Area:
17.5 in W x 11.8 in H x 17.5 in D

Holds 2.09 cu. ft. of soil



MATCHING VINTAGE ICE BUCKET PLANTER AVAILABLE

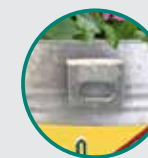

Includes built-in bottle opener

Vintage Ice Bucket Planter

With bottle opener.

83290 / 6 per case

Product Dimensions:
12 in. Dia. x 9.5 in H

Holds 0.79 cu. ft. of soil



Use it as an ice bucket...

or planter!

**A TOP
SELLER!**



**Fits Cans,
Koozies &
Bottles!**
Great for the
Beach, Picnics,
Camping & More!



4 Assorted Colors:

Red Green Blue Yellow

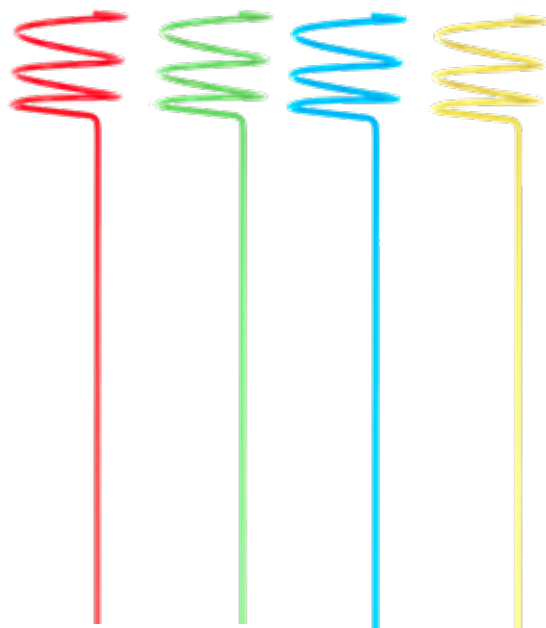

24-PC Beverage Stakes Display

Assorted colors of red, green, blue, and yellow.

87995 / Assorted Colors / 24 per case

Product Dimensions:
4.5 in. W x 36 in. H x 3.25 in. D

Display Dimensions:
17.5 in. W x 36.8 in. H x 7.5 in. D

Shipped in attractive 24 piece display. Six each of the four colors included.

Vintage 3-Tier Serving Tray Planter



Top tray
12" dia.

Middle tray
16" dia.

Bottom tray
20" dia.

Vintage 3-Tier Serving Tray Planter

With wooden handle accent. Packaged in individual Rustic Farmhouse™ brand color boxes.

87915 / Aged Galvanized / 1 per case

Product Dimensions:
20 in. W x 36 in. H x 20 in. D



**Use as a Planter or
Beverage Holder!**

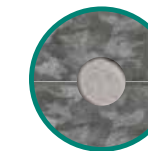

Includes reusable
drain plugs



Dual-Purpose Outdoor Entertaining Planters



**16" W Serving Tray
& Succulents Planter**

83236 / Aged Galvanized / 4 per case

83237 / Brushed Copper Finish / 4 per case

Product Dimensions: 18 in. W x 2.5 in. H x 15.5 in. D



Great for
Miniature
Gardens
or Serving
Beverages!

**Rustic
Wine Bottle
Caddy Planter**

With burlap liner.

83239
Aged Galvanized
2 per case

Product Dims:
7 in. W x 12.5 in. H x 11 in. D



Use As A Planter Or Wine Caddy



Holds 2
Wine Bottles

Or 2 Small 3.5
Poinsettias

Does Double-Duty

As rustic silverware and napkin
caddy or remove the divider
and use it as a planter!



Removable
Dividers



Silverware & Planter Caddy

83243 / Aged Galvanized / 4 per case

Product Dims: 10 in. W x 5.5 in. H x 7 in. D



Herbs Basket
Rust finish.
84270-6 / 6 per case
84270 / 840 per pallet



14" Rustic Hanging Basket with S-hook
84278 / Rust Finish / 6 per case



Egg Gathering Basket / Planter with Burlap Liner
83270 / Rust Finish
10 in. Dia. x 8 in. H
6 per case



Rustic 18" Urn Planter
Poly-lined with drain hole
84272 / 4 per case
Product Dimensions: 18 in. Dia. x 10.5 in. H

Rustic Farmhouse

by PANACEA™

The Rustic Farmhouse Collection of outdoor baskets with rust finish and coated burlap liners are available in a chicken wire or woven wire option.

Chicken Wire

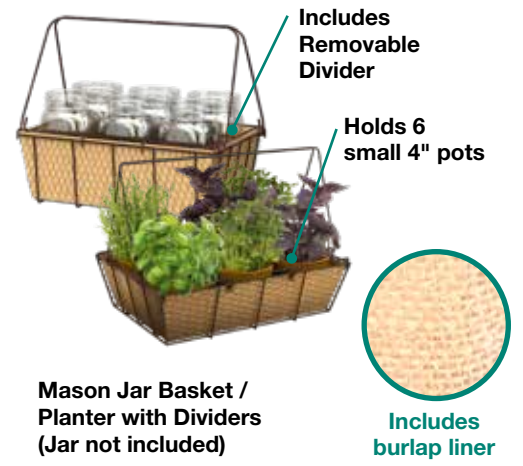

Mason Jar Basket / Planter with Dividers (Jar not included)

Also Use This Item With Small Potted Plants Or Picnic Accessories

14" Rustic Mason Jar Basket Planter
84294 / Rust Finish / 6 per case

Product Dims:
14 in. W x 4.1 in. H x 10.2 in. D

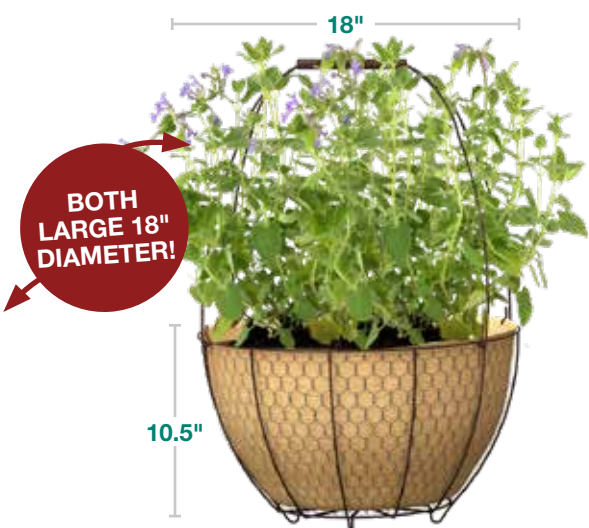

18" Rustic Urn Basket Planter
84288 / Rust Finish / 4 per case

Product Dims:
18 in. Dia x 10.5 in. H

Rustic Wire Planters Woven Wire

14" Rustic Welcome Basket with Handle
83335 / Rust Finish / 6 per case



14" Rustic Narrow Herb Woven Wire Basket with Burlap Liner
83272 / 14 in. W x 5in. D
Rust Finish / 6 per case



24" Rustic Woven Wire Window Box
83330 / Rust Finish / 6 per case



Woven Wire Utility Bushel Baskets

Great for many sizes of potted annuals, perennials, flowers and herbs.
Bring them indoors after the season & they make great utility baskets for utensils, firewood, and numerous other household uses.



Rustic Woven Wire Bushel Baskets with Burlap Liner
83342 / 11 in. W x 6.3 in. H x 11 in. D
Rust Finish / 6 per case
83343 / 14 in. W x 9.3 in. H x 14 in. D
Rust Finish / 6 per case



Also Available In Bulk Quantities & Custom Sizes Upon Request

Rustic Wash Bucket Planters & Tins



16" Farmers Market Oval Planter
83265 / Aged Galvanized / 6 per case
 Holds 3 standard 3 in. plastic herb containers



Galvanized Washtub Planters
83250 / 8 in. dia. / 6 per case
83251 / 10 in. dia. / 6 per case
83232 / 14 in. dia. / 6 per case

Copper Finish Washtub Planters
83215 / 8 in. dia. / 6 per case
83216 / 10 in. dia. / 6 per case



All washtub planters include subtle, upscale Rustic Farmhouse embossed logo.



16" Oval Washtub Planter
83252 / Galvanized / 6 per case
Product Dims:
 16 in. W x 7 in. H x 9.5 in. D

Round Ring Hanging Orb Modern Planter



Compact Merchandising!



Includes drain hole with rubber plug.

Modern Farmhouse Round Ring Hanging Orb Metal Planter

81017 / Matte Black / 6 per case

Product Dims: 17" Dia. Ring, 9" Dia. Planter



Corrugated Steel Silo Planters

Available in 3 sizes:



Corrugated Steel Silo Planters

Aged galvanized finish. All 6 per case.

83326 / 8 in. H
83327 / 10 in. H
83328 / 12 in. H



Capitalize On The Edibles Trend!



These tin herb caddies feature retro graphics and include a trendy aged galvanized finish, as well as hunter green and fire engine red paint colors. A folding handle stays upright or folds back for shelf display.

Holds 4 standard 3 inch plastic herb containers.



Aged Galvanized *Fire Engine Red* *Hunter Green*

Tin Herb Caddies with Handles

Each case includes 2 of each color.

83255 / Assorted Colors / 6 per case

Product Dimensions: 10 in. W x 10 in. H

Features Rope Handles

10" dia. Rustic Olive Bucket

With rope handles.

83242 / Aged Galvanized
 6 per case

Product Dims:
 10.5 in. W x 8 in. H x 10 in. D

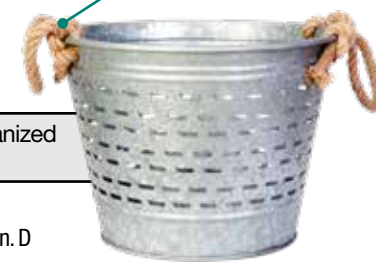

9" Fresh Cut Flower Table Vase

With rope handles.

83234 / Aged Galvanized
 6 per case

83235 / Brushed Copper
 6 per case

Product Dims:
 8 in. W x 9 in. H x 5 in. D



Makes Great Novelty Planters!



14" Square Mini Washtub Planters

83218 / Copper Finish / 6 per case

83233 / Aged Galvanized / 6 per case

Product Dims: 14 in. W x 8 in. H x 14 in. D



Removable Lid

**Milkhouse
Milk Can Planter /
Plant Stand**

82618 / 1 per case

Product Dims:
8.9 in. W x 16 in. H x 9.3 in. D

**New Collection Of White
Enamel-Ware, Vintage Inspired Finish!**



**Milkhouse
Planter Buckets**

82610 / 8 in. H "No 1" / Milkhouse White / 6 per case

82611 / 10 in. H "No 2" / Milkhouse White / 6 per case

82612 / 14 in. H "No 3" / Milkhouse White / 6 per case



**Milkhouse
Canister Planters**

Includes marker, tray, and chalkboard ID tags. Multi-component items are shipped in attractive color box.

82623 / Milkhouse White
4 per case

Product Dims:
15.375 in. W x 6 in. H x 5.5 in. D



Holds 3 Standard 1 QT 4.75" Square Herb Containers



Milkhouse Farm Animal Bucket Planters

2 of each design per case (Rooster / Cow / Sheep / Horse / Pig)

82615 / 7.5 in. H / Assorted Designs / Milkhouse White / 10 per case



**Milkhouse
Vase Planter**

82614 / 9 in. H / 6 per case



**Serving tray makes
great outdoor
entertaining item!**

**Milkhouse
Farm Fresh Serving
Platter**

82628 / 4 per case

Product Dims:
14.2 in. W x 4.1 in. H x 16.7 in. D



**Milkhouse Collection
58 PC Display**

Includes 1 case each of: 82610, 82611, 82612, 82613, 82614 & 82617. Plus 2 cases (20) of 82615 and 4 cases of 82618

90-90385
Loaded 58 PC Display

90-90385EM
Empty Display

Display Dims:
40 in. W x 72 in. H x 18 in. D



**Milkhouse
Feed & Seed Oval Planter**

82613 / 6 per case

Product Dims:
16 in. W x 7 in. H x 9 in. D



**Milkhouse
Large Pitcher
Watering Can / Planter**

82617 / 12 in. H / 4 per case



**Holds
Up to 4
Herbs!**

**Milkhouse
Small Herbs Oval
Planter**

82622 / 6 per case

Product Dims:
16 in. W x 5.3 in. D





New! Flexible 3-in-1 System

Vertical Wall, Balcony & Over-the-Fence Hanging Garden Bar Kit

Vertical Hanging Milkhouse white enamelware tins kits - includes a boxed starter kit with round and oval tins. Hardware for multiple hanging and display configurations included.



Milkhouse 8" Hanging Buckets (2) Planter Kit

Includes two 8" dia. buckets and hardware.

82631 / White Enamel Finish / 4 per case



Milkhouse 16" Hanging Oval Planter Kit

Includes one 16" oval planter & hardware.

82632 / White Enamel Finish / 4 per case

Vertical Gardening & Wall Mount Planters

Create a Living Wall!



Integrated wall mounting plate

Embossed rim in planter holds support ring snugly in place

Milkhouse Vintage Series 8" Wall Planter

With integrated wall-mount planter.

81062 / White Enamel Finish / 6 per case

Planter Dimensions:
8 in. Dia. x 6 in. H



Removable rubber drain plug included.



Shipped in convenient display carton with inspiring vertical gardening color image.

Create a vertical wall garden with these enamelware-inspired tins



Over-the-Rail Planters

Add Flexibility to Planter Placement

These versatile hang-over-anything planters are a simple way to vertical garden on trellises, fences & railings. **Now available in 2 finishes & 2 sizes.**



8" Over-the-Rail Round Metal Planters

With hook hangers included.

81065 / Matte Black / 6 per case

83230 / Galvanized / 6 per case

Planter Dimensions:
8 in. Dia. x 10 in. H



16" Over-the-Rail Window Box Metal Planters

With hook hangers included.

81067 / Matte Black / 6 per case

83231 / Galvanized / 6 per case

Planter Dimensions:
16 in. W. x 10.5 in. H x 9.5 in. D



MOUNT THE HANGING PLANTERS THE FOLLOWING 3 WAYS

Holds Other Planters, Garden Tools, Wall Art And More!

Includes the following components:

- Expandable hanging bar
- (2) Over-the-fence brackets
- (2) Over-the-rail brackets
- (2) Surface mount wall brackets
- (2) S-Hooks - hold tins, baskets, garden tools, watering cans, wall art and more!



1 Over-the-Fence Adjustable Hooks (2)

2 Over A Railing Adjustable Hooks (2)

3 Mounted on Wall Mounting Plates (3)



Aged Galvanized Round Vertical Wall Planter

83227 / 14 in. Dia. / 4 per case

Includes hanger holes on back side



All Wall planters include removable drain plugs and colorful display cartons.



Wall or Tabletop!



Aged Galvanized Half Round Barrel Wall or Tabletop Planter

83228 / 15 in. Dia. / 6 per case

Planter Dims: 15 in. W x 9.5 in. H x 3.5 D (With stand)



Optional no tools, slide-in legs



Easy, key-hole wall attachment

Wall & Table Planter

Modern, Multi-Use Planter

Modern Farmhouse

Round Metal Wall & Table Planter

Has drain hole with rubber plug.

83266 / Matte Black / 4 per case

Planter Dims: 15.7 in. Dia. x 15.7 in. H x 5.1 in. D (16" height with stand)



Easy, key-hole mounting for wall attachment



Optional no-tools slide-in legs for tabletop use.



Compact Merchandising!



MODERN FARMHOUSE HOME & GARDEN

For use on a wall as a vertical garden...

or as a tabletop planter with optional feet included.



AGED GALVANIZED FINISH WITH WHIMSICAL FARM ANIMALS



MILK PAINT FINISH

Vintage Vertical Wall Half Bucket Rustic Planters

Create a vertical wall garden with these vintage half bucket planters in your choice of galvanized, milk paint finish, or whimsical farm motifs.



C AGED GALVANIZED FINISH

Vintage Half Bucket Rustic Wall Planters

A 83222 / Assorted Whimsical Farm Animals 12 per case - 3 each style

B 83221 / Asst. Milkpaint Finish (Teal, Butternut, Eggplant, & Robin Egg Blue) 12 per case - 3 each style

C 83220 / Aged Galvanized Finish 12 per case

Planter Dimensions: 10.25 in. W x 8.5 in. H x 5.375 in. D



SHIPPED IN DECORATIVE DISPLAY CARTONS!



Create a living wall garden with these rustic industrial file cabinet planters.

File Drawer Planters

In Beautiful Milk Paint Assorted Colors

Includes chalkboard ID marker plates for added customization!



Rustic Industrial File Drawer Planters

Mount them on a wall to create an "Industrial Chic" wall garden!

83224 / Asst. Milk Paint Colors / 12 per case - 3 each color

Planter Dimensions: 8 in. W x 8 in. H x 7 in. D



Dual Keyhole mounting holes for attaching to wall

SO MANY USES: (indoors or outdoors)

- Vertical Wall Garden
- Table Top Planter
- Mail Sorter
- Pantry, Kitchen, office or crafts organizer
- Plus more!

PANACEA™
INDUSTRIAL
COLLECTION

Novelty Metal Planters

Industrial Planter Bins

8"



8" H Industrial Planter Bins

86695 / Antique Red
4 per case

Product Dimensions:
8 in. W x 8 in. H x 8 in. D

12"



12" H Industrial Planter Bins

86694 / Antique Red
4 per case

Product Dimensions:
9 in. W x 12 in. H x 9 in. D

16"



16" H Industrial Planter Bins

86678 / Antique Red
4 per case

Product Dimensions:
10 in. W x 16 in. H x 10 in. D

See These Matching
14" Industrial Hanging
Baskets In Assorted
Vintage Color Pack
On Page 36

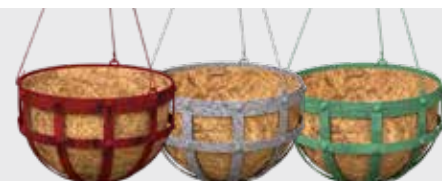

Antique
Red

Antique
Iron

Antique
Green



Industrial Flat Band Tractor & Wagon Coco Planters

Vintage & Whimsical

This wagon planter has been a top seller for retailers and growers for the last 3 years!

Industrial Flat Band Wagon Planter

With moving wheels & sewn-in coco liner.

86688 / Antique Red / 2 per case

Product Dimensions:

7 in. H x 16.5 in. W x 10 in. D (Not including handle)

Planting Area:

5.5 in. H x 15.5 in. W x 8.5 in. D



TOP
SELLER!

Wheels really move!

Vintage Red Tractor Coco Planter

Tractors remain a popular motif. This new tractor planter is sure to be a winner too!

Vintage Red Tractor Planter

With moving wheels & sewn-in coco liner.

86675 / Antique Red / 1 per case

Product Dimensions:

14.5 in. H x 24 in. W x 9.5 in. D

Planting Area:

6 in. H x 16 in. W x 8.5 in. D



Dramatic
24" Width!



Also Available In Bulk For High Volume Growers



Retro Collection Metal Chair Planters

Includes 8" matching tin planters.

86625 / Assorted Colors (2 each of red, white, and teal) 6 per case

Product Dimensions:
13.8 in. W x 20.5 in. H x 11.5 in. D

Teal

White

Red



Retro Collection Metal Pot Covers

With perforated circle design.

86693 / Assorted Colors (2 each of red, white, and teal) / 6 per case

Product Dimensions:
7 in. Dia. x 7 in. H

**Assorted Case Packs
Include 3 colors**

Individually Boxed

The wagon and tractor planters are shipped in attractive color boxes – great for eCommerce!

Or Save \$

These fun planters are available in bulk for high volume growers on bulk pallets – no color boxes. Ask your Panacea representative for more details.



Modern Farmhouse Baskets & Planters

Metal Planters with Matte Black Finish & Copper Plated Handles



16" Modern Farmhouse Oval Washtub Planter

Includes removable drain plug.

81429 / 16 in. Oval
Matte Black / 6 per case

14" Modern Farmhouse Washtub Planter

Includes removable drain plug.

81428 / 14 in. dia.
Matte Black / 6 per case

10" Modern Farmhouse Washtub Planter

Includes removable drain plug.

81427 / 10 in. dia.
Matte Black / 6 per case

8" Modern Farmhouse Washtub Planter

Includes removable drain plug.

81426 / 8 in. dia.
Matte Black / 6 per case

Distinctive & Functional Features



Copper Handles add modern yet classic appeal.



Includes Removable Rubber Drain Plug

Wire Baskets with Fashionable Bistro Print Liners



Modern Farmhouse Bushel Baskets with Bistro Print Liners

With sewn-in poly lining.

81421 / 8 in. dia. / 6 per case

81422 / 10 in. dia. / 6 per case

81424 / 16 in. Oval / 6 per case

All Weather Bistro Print fabric liners trendy and looks great indoors or outside!



Sewn-in poly lining prevents leaking & soiled liner

Multi-Purpose Containers



GARDEN

OR



HOME

Harvest Trug Basket / Planter

A Planter in the Summer & Harvest Basket In the Fall

Includes bistro poly-lined fabric insert with drain hole for use as a planter.

Or remove liner if desired and use as a gathering basket.

Trug Harvest Basket / Planter with Bistro Print Liner

83269 / Matte Black
6 per case

Product Dims:
7.25"H x 22.5"W x 11"D



See These Matching Accessories and Our Other Watering Cans On [Pg. 122-123](#)

Add More Impact With a Full Display of Modern Farmhouse Planters & Accessories!

Modern Farmhouse 58 pc. Planters / Containers Display

90-90451 / 58 PC LOADED

Includes 2 cases ea. of all 8" planters, 1 case of all 10", 14" and oval planters & 2 cases of mister & watering can boxed sets

90-90451EM / EMPTY

Build-Your-Own Asst. Container Display



The Classic Finial

And Other Popular Hanging Baskets

14" **Classic Finial Hanging Basket**
88512 / Black / 6 per case
Product Dimensions: 7 in. H x 14 in. Dia.

The Classic Finial is a Best Seller!
U.S. Patent No. D576.073



14" **Contemporary Square Hanging Basket**
87850 / Black / 6 per case
Product Dimensions: 14 in. Dia x 7.75 in. H



14" **English Wide Band Hanging Basket**
87811 / Black / 6 per case
Product Dimensions: 14 in. Dia. x 10.75 in. H

Best Selling Classic Finial



Charleston Hanging Basket
88575 / Antique Black / 4 per case
Product Dimensions: 12.5 in. H x 14 in. Dia.



Scroll Hanging Basket
88668 / Black / 12 per case
Product Dimensions: 6 in. H x 12 in. Dia.



Cameo Hanging Basket
88524 / Cameo Brown / 6 per case
Product Dimensions: 7 in. H x 14 in. Dia.

Flat Wide Band Styles



Flat Iron Hanging Basket
88551 / Black / 6 per case
Product Dimensions: 7.8 in. H x 14 in. Dia.



English Wide Band Hanging Basket
84230 / Black / 6 per case
Product Dimensions: 7 in. H x 12 in. Dia.



English Wide Band Hanging Basket
84231 / Black / 6 per case
Product Dimensions: 7 in. H x 14 in. Dia.

Wire Scroll



Star Hanging Basket
88510 / Black / 6 per case
Product Dimensions: 7 in. H x 14 in. Dia.



Homeland Hanging Basket
87820 / Bronze Finish / 6 per case
Product Dimensions: 8 in. H x 14 in. Dia.



Available in 2 sizes:



Cotswold Hanging Basket
88533 / 14 in. Dia. / Black / 6 per case
Product Dimensions: 7.3 in. H x 14 in. Dia.
88536 / 18 in. Dia. / Black / 4 per case
Product Dimensions: 7.5 in. H x 18 in. Dia.

Assorted Wire & Banded Styles

Flat Iron & Wide Band

Hanging Basket Merchandising Options

Display Carton
 Includes shelf ready display carton.
 Standard for all cases.



Multi-Basket Display
 *This flexible display can hold round, square and trough baskets + coco liners.
90021 (Empty) / Black



Single Stack Basket Display
 *Fits most 12"/14" round baskets
90-90020 (Empty) / Black

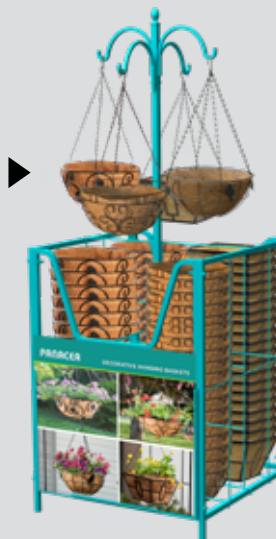

MODERN FARMHOUSE
HOME & GARDEN



Modern Farmhouse Hanging Basket

81435 / Black / 6 per case

Product Dimensions: 14 in. Dia. x 7.5 in. H

RUSTICA
ITALIA



Rustic Italia Hanging Basket

82374 / Bronze / 6 per case

Product Dimensions: 14 in. Dia. x 6.7 in. H

12" 14"



Black Rattan Hanging Basket

88640 / 12 in. Dia. x 5.1 in. H
10 per case

88641 / 14 in. Dia. x 5.9 in. H
10 per case

14"



Willow Hanging Basket

83555 / 14 in. Dia. / 6 per case

Product Dimensions:
14 in. Dia. x 7 in. H

12"



Rope & Fern Cone Hanging Basket

88636 / 12 in. Dia. / 10 per case

Product Dimensions:
12 in. Dia. x 14 in. H



Bee-Conscious Hanging Basket

81452 / Black / 6 per case

Product Dimensions: 14 in. Dia. x 8.5 in. H

MISSION
COLLECTION



Mission Collection Hanging Basket

82176 / Black / 6 per case

Product Dimensions: 14 in. Dia. x 7.1 in. H

14"



Moss Square Hanging Basket

83557 / 6 per case

Product Dimensions:
14 in. Dia. x 6.5 in. H

See more
**Moss
Items**
on
page 49

13"



Moss Square & Vine Hanging Basket

83556 / 6 per case

Product Dimensions:
13 in. Dia. x 7 in. H

GREAT
PROMO
DISPLAY!



Resin Wicker Hanging Basket Display

Includes 6 of each color shown.

82300 / Asst. Colors / 24 piece

SEE MORE MATCHING COLLECTION ACCESSORIES THROUGHOUT THIS CATALOG

**Made-in-the UK
Collection**

**Spanish
Hanging Basket**

Unique PE coating.
82040A / Black PE coating
2 per case

Product Dimensions:
13.75 in. Dia. x 26 in. H

**Unique PE
Coating**

Provides a soft,
climbing surface for
plants while giving each
piece a more rugged,
thicker appearance.



Industrial Collection

14"



Industrial Flat Band Hanging Basket

Antique Red, Iron, & Green Finishes
84215 / 6 per case / Includes 2 ea. color shown

Product Dimensions:
14 in. Dia. x 9.8 in. H



TOP
SELLER!

Durable woven
resin looks great
for years!

**Resin Wicker
Hanging Baskets**

Resin Wicker Hanging Basket

All 6 per case.

82302 / Grey

82301 / Black

82303 / Espresso Brown

82304 / White

82305 / Natural Wicker

Product Dimensions:
14 in. Dia. x 7 in. H

A Great Companion
To Popular Resin
Patio Furniture!



Available In 5 Color Options!



Grey

Black

Natural
Wicker

Espresso
Brown

White

Economy Painted Grower Hanging Baskets

With Chains (Standard Depth – No Poly Lining)



Painted Grower Hanging Basket with Chain

Available in White, Black or Green

Painted Grower Hanging Baskets with Chain

88500 / 12" Dia. / Green / 12 per case
88503 / 14" Dia. / Green / 12 per case
88506 / 16" Dia. / Green / 12 per case
88504 / 14" Dia. / White / 12 per case
88507 / 14" Dia. / Black / 12 per case



Professional Grower Hanging Baskets

Commercial quality hanging baskets for the professional grower

Economical & Efficient

We bring in several ocean containers annually of these Special Buy Wire Coco baskets to offer you a competitively-priced commercial hanging basket that looks great and is easy to fill.

- Deeper shape to hold more soil and water
- Full poly lining with perforated drain hole keeps coco lining looking fresh and basket from drying out too quickly
- Clip on nylon hanger makes assembly easy and fast. Includes tag slot for attaching plant identification tag and UPC.
- Available in large case packs (25 per with UPC sticker), or in large, bulk pallet quantities (no packaging).
- Each pallet is individually wrapped for outdoor storage
- Black, powder coated wire (wont bubble like PE coating)



12" (2 GAL) Hanging Basket With Plastic Hanger

84203 / Bulk Pallet / 880 pieces

14" (2.5 GAL) Hanging Basket With Plastic Hanger

84201 / Bulk Pallet / 720 pieces

16" (3.25 GAL) Hanging Basket With Wire Hanger

84204 / Bulk Pallet / 400 pieces

20" (4.5 GAL) Hanging Basket With Wire Hanger

84208 / Bulk Pallet / 300 pieces

84204-25 / 25 per case

84208-25 / 25 per case

MORE ITEMS FOR THE PROFESSIONAL GROWER

Our professional grower resource guide includes more items that we can provide for the professional grower including: wire hangers, hooks, baskets, planters, plant supports, and novelty items. We also offer wreath frames, wire ease stands, and floral supplies including rock and gem fillers.

For large volume orders (2500 or more pieces), we offer complete design and customization concepts. For more information or a custom quote, send an email to: ProGrower@PanaceaProducts.com or call our customer service department at 800-543-0031.



Hangers can also be purchased separately. Styles available include:

19" Length Wire Grower Galvanized Basket Hanger
88628 3 Strand / 25 per case
84205B 3 Strand Bulk / 500 per pallet
88629 4 Strand / 20 per case
88629B 4 Strand Bulk / 500 per pallet

19" Length Wire Grower Plastic Basket Hanger
84205 3 Strand / 20 per case
84205B 3 Strand Bulk / 500 per pallet
84202 4 Strand / 20 per case
84202B 4 Strand Bulk / 500 per pallet

NEW! 3 & 4 Strand Black Painted
19" Length Wire Grower Black Painted Basket Hanger
84257 3 Strand / 25 per case
84257B 3 Strand Bulk / 500 per pallet
83376 4 Strand / 20 per case
83376B 4 Strand Bulk / 500 per pallet

MISTURE KEEPER

Premium Grower Baskets

WITH POLY INSERTS & WIRE HANGERS



SEE THE DIFFERENCE!



Available In 2 Sizes: 14" & 16"

- Black Powder Coated Hanging Wire
- Machine Formed
- Fits Standard Size Coco Liners & Poly Inserts
- Includes Promotional Color Hangtag

14" (2.5 GAL) Premium Grower Basket With wire hanger.

84255 / Bulk 750 per pallet
84255-25 / 25 per case

16" (3.25 GAL) Premium Grower Basket With wire hanger.

84256 / Bulk 400 per pallet
84256-25 / 25 per case

Hanging Basket Stands

Provide More Space to Hang Baskets!



Folding Hanging Basket Stands

Heart Hanging Basket Hanger with Shelf

88100 / Black
6 per case

Product Dimensions:
16 in. W x 40 in. H x 20 in. D

Modern Farmhouse "Welcome to our Home" Basket Hanger

81438 / Matte Black
6 per case

Product Dimensions:
16.6 in. W x 40 in. H x 15 in. D



Modern Farmhouse "Welcome" Basket Hanger

Yard Stake Hanging Basket Stands

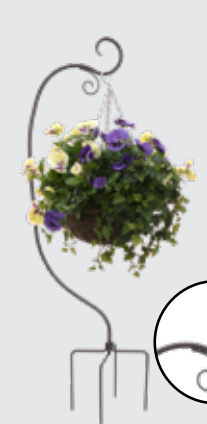

48" H Scroll Basket Stake Hanger

88195 / Black
8 per case

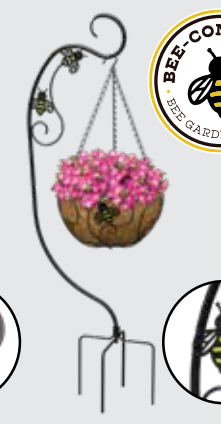

40" H Bee-Conscious Basket Stake Hanger

81455 / Black
8 per case



Multiple 4-Way Hanging Basket Stands

Scroll Free Standing Square Tube Basket Hanger

Black finish.

88155 / 72 in. H / 1 per case

Product Dimensions:
36 in. W x 72 in. H x 36 in. D

Modern Farmhouse Free Standing Square Tube Basket Hanger

Black finish with copper accents.

84632 / 72.5 in. H / 1 per case

Product Dimensions:
27 in. W x 72 in. H x 27 in. D



Fits in compact color box (under 48")

*All Hanging Baskets Sold Separately



**POPULAR
PLANTER**

*Scroll
Floor Planter*
88568 / Black / 6 per case
Product Dimensions:
11 in. H x 14 in. W x 14 in. D

POPULAR PLANTER FOR GROWERS – AVAILABLE IN HIGH VOLUME BULK QUANTITIES

Three-Tier Oval Washtub Planter



Each galvanized tub includes a removable rubber plug for adequate drainage

**Showcases
Flowering
Plants In a
Compact
Space!**



*Three-Tier
Oval Washtub Planter with Stand*
82204 / Galvanized / 1 per case
Product Dimensions:
21 in. W x 43 in. H x 22.5 in. D



Coco Floor Planters



*French Country
Floor Planter*
Distressed White Finish.
84282 / 6 per case
Product Dimensions:
14 in. Dia. x 8 in. H



Trellis with Planter Box & Liner
Includes coco liner.
84545 / Black / 1 per case
Product Dimensions:
32 in. W x 76 in. H x 16 in. D

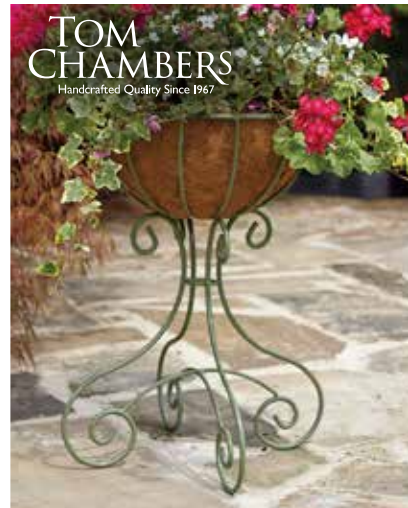

*Tom Chambers
Fiore Planter*
82022 / Sage Green / 4 per case
Product Dimensions:
13.8 in. W x 23 in. H x 13.8 in. D



*Tom Chambers
Urn Planter*
82020 / Black / 4 per case
Product Dimensions:
13 in. W x 18 in. H x 13 in. D

RUSTICA ITALIA Wicker Hearth & Patio Planter



*Tuscan Resin
Wicker Hearth & Patio Planter with Stand*
82335 / Espresso Brown / 4 per case
Product Dimensions: 16 in. Dia. x 16 in. H



MODERN FARMHOUSE
HOME & GARDEN

Modern Farmhouse
Wall Planter

81437 / Black / 4 per case

Product Dims:
12 in. W x 7.5 in. D x 19.5 in. H



Contemporary
& More Designer Styles



30" *Contemporary*
Window & Deck Planter

87857 / Black / 6 per case

Product Dimensions:
30 in. W x 8 in. H x 8 in. D



Wall Planters For Any Need!

Available in many styles and sizes. All wall planters include coco liners & mounting hardware except where noted.

Coco Deck & Window Planters



*Mounting Hardware Not Included

Cameo
Wall Planter

88527 / Cameo Brown / 6 per case

Planter Dims: 16 in. Dia. x 8 in. H x 8 in. D



Flat Iron
Wall Planter

88554 / Black / 6 per case

Planter Dims: 16 in. Dia. x 7 in. H x 8.3 in. D



Cameo Collection
Window & Deck Planter

88530 / Cameo Brown / 6 per case

Product Dimensions: 30 in. W. x 8 in. H x 7.8 in. D



Classic Finial
Window & Deck Planter

88518 / Black / 6 per case

Product Dimensions: 30 in. W. x 8 in. H x 8.3 in. D



Cotswold
Wall Planter

88539 / Black / 6 per case

Planter Dims: 16 in. Dia. x 7.8 in. H x 8 in. D



Grower
Wall Planter

88509 / Green / 12 per case

Planter Dims: 16 in. Dia. x 7.9 in. H x 8.5 in. D

*Mounting Hardware Not Included



Modern Farmhouse
Window & Deck Planter

81436 / Black / 6 per case

Product Dimensions: 30 in. W. x 8 in. H x 8 in. D

*Mounting Hardware Not Included



Mission Collection
Window & Deck Planter

82175 / Black / 4 per case

Product Dimensions: 30 in. W. x 8 in. H x 8 in. D

*Mounting Hardware Not Included



36"

Commercial Grade

Appropriate for Residential, Commercial & Municipal



Homeland Collection
36" Window & Deck Planter

87828 / Oil Rubbed Bronze / 3 per case

Product Dimensions: 36 in. W x 9 in. H x 9 in. D



24"

24" English Wide Band Window & Deck Planter

84232 / Black / 4 per case

Product Dimensions:
24 in. W x 8 in. H x 7 in. D



30"

30" English Wide Band Window & Deck Planter

84233 / Black / 4 per case

Product Dimensions:
30 in. W x 8 in. H x 7 in. D



36"

36" English Wide Band Window & Deck Planter

84234 / Black / 4 per case

Product Dimensions:
36 in. W x 8 in. H x 7 in. D

English Wide Band (With coco liner included)



30"

30" Flat Iron Window & Deck Planter

88557 / Black / 4 per case

Product Dimensions:
30 in. W x 8 in. H x 7.8 in. D



36"

36" Flat Iron Window & Deck Planter

88558 / Black / 4 per case

Product Dimensions:
36 in. W x 8 in. H x 7.8 in. D



48"

48" Flat Iron Window & Deck Planter

88559 / Black / 4 per case

Product Dimensions:
48 in. W x 8 in. H x 7.8 in. D

Flat Iron (With coco liner & mounting hardware included)



22"

22" Cotswold Window & Deck Planter

88542 / Black / 4 per case

Product Dimensions:
22 in. W x 10 in. H x 10.9 in. D



30"

30" Cotswold Window & Deck Planter

88545 / Black / 4 per case

Product Dimensions:
30 in. W x 8.4 in. H x 8 in. D



36"

36" Cotswold Window & Deck Planter

88548 / Black / 4 per case

Product Dimensions:
36 in. W x 8 in. H x 7.9 in. D

Cotswold (With coco liner & mounting hardware included)

DON'T FORGET OUR

Vinyl Siding Hanger Hooks

60176 / 4 pieces / 6 per case

Elegant Copper Finish Metal Window Planters

24" Boulevard™ Window & Deck Planter

83525 / Black / 1 per case

Product Dimensions:
24 in. W x 9.7 in. H x 9.7 in. D



24"

30" Boulevard™ Window & Deck Planter

83527 / Black / 1 per case

Product Dimensions:
30 in. W x 9.7 in. H x 9.7 in. D



30"

36" Boulevard™ Window & Deck Planter

83529 / Black / 1 per case

Product Dimensions:
36 in. W x 9.7 in. H x 9.7 in. D



36"



Mixed Material Deck & Window Planters



24"

Balcony Flower Box Holder

88590 / Black / 4 per case

Planter Dimensions: 24 in. W x 8.3 in. H x 9.1 in. D

*Clay Pots Not Included.



15"

Classic Finial Flower Box Holder

88515 / Black / 6 per case

Planter Dimensions: 15 in. W x 6 in. H x 9.9 in. D

*Plastic Insert Not Included.



Resin Wicker Collection Window & Deck Planter

82311 / Black / 6 per case

Product Dimensions:
24 in. W x 5.5 in. H x 7 in. D

24"

Resin Wicker Collection Window & Deck Planter

82314 / White / 6 per case

Product Dimensions:
24 in. W x 5.5 in. H x 7 in. D

24"

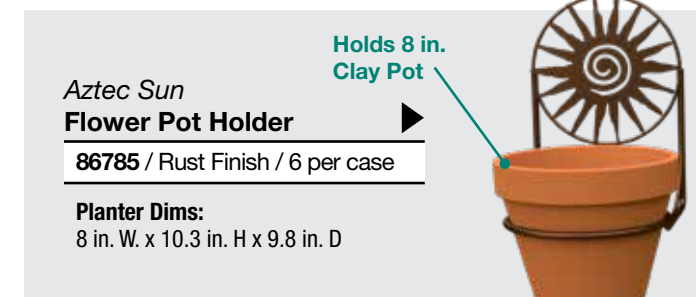

Aztec Sun Flower Pot Holder

86785 / Rust Finish / 6 per case

Planter Dims:
8 in. W x 10.3 in. H x 9.8 in. D

Holds 8 in. Clay Pot

A



URBAN GARDENER

Glass Terrarium Planters

These glass containers are ideal for succulents and cacti, as well as other small plants that prefer less humidity. With a variety of sizes and shapes, these glass containers offer the best view of plants and adornments.



A Large Glass Terrarium Planter

With feet.

82145 / 2 per case

Product Dimensions:
10.5 in. H x 10 in. Dia.

B Conservatory Terrarium

Top opens with hinge for easy planting.

81020 / 2 per case

Product Dimensions:
7 in. W x 11 in. H x 7 in. D

C Unique Hand-Blown Glass Terrarium

With recycled glass, cork lid, and jute wrapped trim.

81021 / 2 per case

Product Dimensions:
9 in. H x 12 in. Dia.

D Glass Terrarium Tabletop Planter

82148 / 4 per case

Product Dimensions:
4 in. H x 10 in. Dia.

E Desktop Glass Terrarium Planter

With black finish metal stand.

82149 / 6 per case

Product Dimensions:
7.5 in. H x 4 in. Dia.

Succulent Trays & Planters

For Succulents and Other House & Garden Plants



Shelf-ready packaging available

Copper Finish Succulent Trays ▲

Available in 3 sizes. All 6 per case.

82190 / Small / Tray Dims: 2 in. H x 12 in. W x 6 in. D

82191 / Medium / Tray Dims: 2 in. H x 18 in. W x 5 in. D

82192 / Large / Tray Dims: 2 in. H x 24 in. W x 5 in. D



10" Tabletop Contemporary Hammered Succulent Tray

82197 / Copper Finish
6 per case

16" Aged Galvanized Round Tabletop Planter

83302 / 4 per case

Cross Hatch Planter

With galvanized insert and matte black frame.

81060 / 6 per case

Product Dims:
6 in. H x 13.5 in. W x 7.5 in. D

Wire & Wood Terrarium Planter

(No Glass)

82206 / Black /
2 per case

Product Dims:
12 in. H x 11.5 in. W x 8 in. D

Hammered Copper Finish



Protects window sills and provides a saucer for houseplants. Or use as a shallow planter for succulents.

Lantern Planters

Easy Access Holds a 6.5" standard plastic drop-in pot

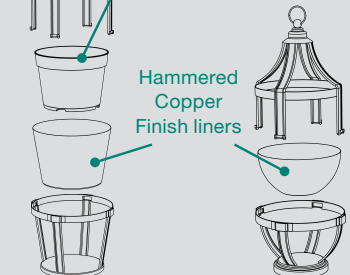

Large Planter

Small Planter



Large 18" H Lantern Planter use for larger plants

Small 13" H Lantern Planter use for smaller succulents & cacti

Lantern Planters with Hammered Copper Finish

82196 / 13" Short / 6 per case

82195 / 18" Tall / 6 per case



B

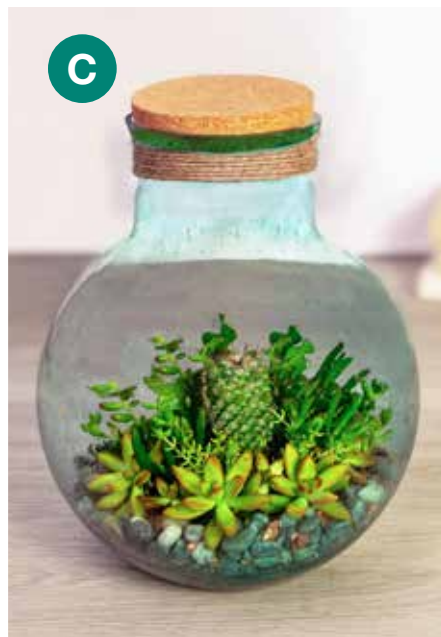

C



D



E



Packaged in Urban Gardener® branded full color box

Boxed Succulents Planter

With 3 mini 6" hanging wire scroll baskets and metal stand.

82151 / Black / 1 per case

Product Dims: 16 in. H x 17 in. W x 17 in. D



Bird Cage Succulent Planter ▲

82205 / Black / 2 per case

Product Dims:
10" Dia. x 21"H

AQUA STONES™

NEW! Terrarium Fillers

Water Absorbing Rocks For Terrariums & Planters

Introducing an attractive, new no-soil alternative – Aqua Stones™. A natural, versatile plant substrate that adds color and vitality to plants both indoors and out. Perfect for terrariums or hydroponic planting, Aqua Stones can be used to plant directly into, layered over, or between potting soil. Not only does it hold moisture in the pot, but it keeps plants watered and looking fresh longer.

General Information:

- Expanded Clay – Durable Lightweight Aggregate
- Low Density & High Strength
- Water Absorption 25 – 40% Volume
- Recyclable
- Resistant To Fire
- Ecologically Colored
- Sustainable
- Soil Improvement
- For Hydroponics
- Certified UV Resistance (TUV.LGA)
- Indoor & Outdoor Use



Olive Aqua Stones

81044 / 6 per case



Lava Brown Aqua Stones

81043 / 6 per case



Black Aqua Stones

81040 / 6 per case



Tan Aqua Stones

81042 / 6 per case

A great decorative terrarium filler, or use as soil substitute as hydroponic growing medium.

Porous Structure Promotes Root Growth



Both Aqua Stones™ & Terrarium Starter kits come packaged in 4.5" dia. x 6"H Jars

Merchandising Solutions

For Container Fillers, Pot Toppers & Natural Accents



Terrarium Starter Accessory Kits

New Themed Kits Offer Variety. Each Themed Kit Includes An Unique Assortment.



Grow Your Terrarium, Succulent & Miniature Garden Accessory Business!

Rainforest Terrarium Starter Accessory Kit

81032 / 6 per case

- White Opaque Rocks
- Gold Mini Rocks
- Crushed Shells
- Glass Stones
- Pectin Shells
- Moss/Seaweed

Beach Terrarium Starter Accessory Kit

81030 / 6 per case

- White Coarse Sand
- Sea Glass
- Natural Driftwood
- White Shell Mix
- Crushed Shells
- Resin Starfish
- Moss/Seaweed

Woodland Terrarium Starter Accessory Kit

81033 / 6 per case

- Green Crushed Glass
- Clear Glass Stones
- Faux Moss Rocks
- Natural Wood Chunks
- Brown Lava Rock
- Moss/Seaweed

Southwest Terrarium Starter Accessory Kit

81031 / 6 per case

- Natural Sand
- Metallic Mini Rocks
- Auburn Glass Stones
- River Rocks
- Moss/Seaweed

Basic Terrarium Accessory Kit

74360 / 6 per case

- Plain Green Moss
- Assorted Pebbles
- Imitation Soil
- Tumbled Glass
- Etched Rocks

Raffia Palm Tree Fibers

All 61 cu. in.

- A 21180 / Natural Finish / 16 per case
- B 21188 / Assorted Colors / 4 per case

Akasha Pebbles, Rocks, Gravel, & Sand

All 6 per case

- C 77508 / White River Pebbles / 4lbs
- D 77507 / Mixed River Pebbles / 5lbs
- E 77502 / Black River Pebbles / 5lbs
- F 77500 / Countryside River Rocks / 5lbs
- G 77505 / Kalahari Gravel / 4lbs
- H 77501 / Beach Sand / 5lbs

Moss Fillers, Liners, & Baskets

- I 21063L / Natural Spanish Moss / 250 cu. in. / 12 per case
- J 21130L / Preserved Sheet Moss / 90 sq. in. / 12 per case
- K 83581 / Moss Round Liner / 12 in. W / 12 per case
- L 83582 / Moss Round Liner / 14 in. W / 12 per case
- M 83557 / Moss Square Hanging Basket / 14 in. W / 6 per case
- N 83556 / Moss & Vine Hanging Basket / 13 in. W / 6 per case

More Floral & Decorative Container Decorating Ideas In Our Floral Catalog.

Panacea offers thousands of useful items for garden centers and the floral industry in the Panacea Floral Catalog. From rocks and glass gems, seashells, raffia and multiple styles of moss, you'll find numerous products to offer your miniature gardening enthusiast.

Raffia, Spanish Moss & More!



Merchandising Solutions For Coco Fiber & Moss Liners

IN 6 SIZES!



**Round
Coco Fiber
Replacement Liner**

84166 / 10" / 24 pc
88591 / 12" / 24 pc
88592 / 14" / 24 pc
88593 / 16" / 12 pc
88594 / 18" / 12 pc
87823 / 20" / 6 pc



**Half-Round
Coco Fiber
Replacement Liner**

88596 / 16" / 12 pc
88597 / 22" / 12 pc



**Square
Coco Fiber
Replacement Liner**

84168 / 14" / 12 pc
84167 / 12" / 12 pc



IN 4 SIZES!

**Trough
Coco Fiber
Replacement Liner**

84169 / 24" / 12 pc
88598 / 30" / 12 pc
88599 / 36" / 12 pc
88595 / 48" / 12 pc



Round, Half-Round, Square, and Trough liners are shipped in shelf-ready packaging



**Round
Moss Replacement Liner**

Chain & Basket not included.

12" 83581 / 12 per case
14" 83582 / 12 per case

Spanish Moss Filler

21063 / 250 cu. in. / 24 per case
21067 / 500 cu. in. / 12 per case



**Bulk
Roll Display**

90-90052 / Loaded (Includes one ea. of 88588 and 88589)
90-90026 / Empty



**Bulk
Coco Liner Roll**

In 2 sizes. All 1 per case.

88588 / 24" W x 33' L
88589 / 36" W x 33' L



**Cut-to-Size
Coco Sheet**

36" x 36" Sheet. Includes display carton.

88698 / 6 per case



**Poly Bagged
Coco Liner**

Fits 16" Basket or less.

88587 / 24 per case

MOISTURE KEEPER Eco-Friendly & Sustainable!

All-Natural Water Storing Granules

- Use with pots, planters, hanging baskets & much more!
- Stores 80 times its weight in water
- A blend of natural plant materials & minerals
- All Natural & Safe for Pets & Children

Moisture Keeper™ Water Storing Granules

340g / 12oz.
73197 / 6 per case

Premium Coco Liners Less Watering & Healthier Plants!

MOISTURE KEEPER™



See The Difference!
Includes recyclable full poly insert with side drain hole for less watering.



Machine-Formed
For tight, consistent soil & water retention!



NO LOOSE FIBERS!
SEE THE DIFFERENCE!



Available In 5 Popular Sizes!



**12" Moisture Keeper
Round Coco Refill
Basket Liner**

82350 / 24 per case



**30" Moisture Keeper
Trough Coco Refill Basket Liner**

82353 / 12 per case



**14" Moisture Keeper
Round Coco Refill
Basket Liner**

82351 / 24 per case



**36" Moisture Keeper
Trough Coco Refill Basket Liner**

82354 / 12 per case



**16" Moisture Keeper
Round Coco Refill
Basket Liner**

82352 / 12 per case

Efficient & Eye-Catching Merchandising

Coco liners include shelf-ready display cartons with colorful product labels or in bulk promotional high volume display bins.



Bulk example shown to the right. See your Panacea Representative to create your own high volume assortment.





VINTAGE Grow Bags

**FUN &
ATTRACTIVE
GARDENING...
ANYWHERE!**

- **Portable** - for deck, patio & balcony gardening
- **Easy to use** - just fill with potting soil and add plants or seed
- All natural burlap fabric is **coated for water retention** and includes reinforced drain hole for adequate drainage
- **Rugged**, reinforced seams for added strength
- **Reusable** - folds flat for seasonal storage

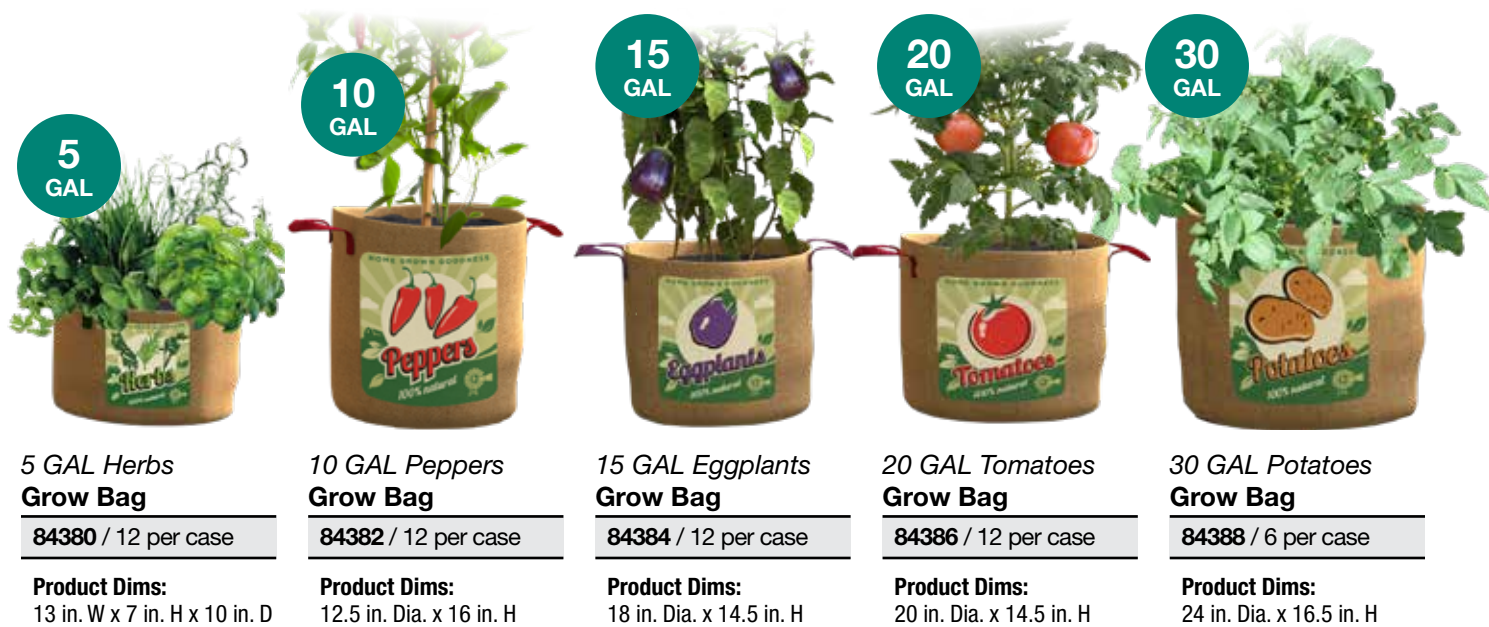

5 GAL Herbs Grow Bag 84380 / 12 per case Product Dims: 13 in. W x 7 in. H x 10 in. D	10 GAL Peppers Grow Bag 84382 / 12 per case Product Dims: 12.5 in. Dia. x 16 in. H	15 GAL Eggplants Grow Bag 84384 / 12 per case Product Dims: 18 in. Dia. x 14.5 in. H	20 GAL Tomatoes Grow Bag 84386 / 12 per case Product Dims: 20 in. Dia. x 14.5 in. H	30 GAL Potatoes Grow Bag 84388 / 6 per case Product Dims: 24 in. Dia. x 16.5 in. H
---	---	---	--	---



Burlap Round Replacement Liners

Shipped In Display Cartons

Round Burlap Assorted Replacement Liners Assorted fashion colors & prints. Includes sage, botanical, blue, & burgundy	Round Burlap Natural Jute Replacement Liners
12" 83503 / 12" Dia. / 12 per case	12" 83501 / 12" Dia. / 12 per case
14" 83504 / 14" Dia. / 12 per case	14" 83502 / 14" Dia. / 12 per case

Vintage

Feed & Seed, Flour, & Coffee Grow Bags

Old re-purposed bags look great as planters! With attractive faux leather and all weather treated canvas, these poly-lined grow bags make great conversation pieces as grow bag planters. Includes reinforced drain hole for adequate drainage.

10 GAL Feed & Seed, Flour, & Coffee
Vintage Grow Bags

84399 / 12 per case (3 each of 4 designs)

Planter Dims: 12.5 in. Dia. x 16 in. H



DISPLAY AVAILABLE ON PAGE 145



Vintage Burlap Patio Planter

A companion to our current vintage grow bag line, this folding frame planter capitalizes on the home grown "edibles" popularity. Includes tarp-like liner with drain holes in a vintage burlap shell that is suspended from an industrial strength frame with decorative accents.



Vintage
Burlap Grow Bag Patio Planter with Stand & Shelf

83274 / 4 per case

Planter Dims: 25.5 in. W x 35 in. H x 19.25 in. D

Planting Area: 24 in. W x 12 in. H x 12 in. D

Vintage
Burlap Grow Bag Replacement Liner

84359 / 4 per case



Plant Stands



U.S.A. Made Plant Stands



All Heavy Duty Plant Stands Feature A 9 In. Top Opening



15 in. Heavy Duty Plant Stand

All 6 per case

89237 / Black
89231 / White
89230 / Green

21 in. Heavy Duty Plant Stand

All 6 per case

89238 / Black
89233 / White
89232 / Green

30 in. Heavy Duty Double Plant Stand

All 6 per case

89239 / Black
89245 / White
89244 / Green

Heavy Duty



French Country
SCROLL COLLECTION

All Cameo Plant Stands Feature A 9 In. Round Top and French Country Plant Stands Feature A 10 In. Round Top



11.5 in. French Country Scroll Plant Stand

83373 / Distressed White / 6 per case

16 in. French Country Scroll Plant Stand

83374 / Distressed White / 6 per case

10 in. Cameo Plant Stand

89154 / Cameo Brown / 6 per case

15 in. Cameo Plant Stand

89155 / Cameo Brown / 6 per case

20 in. Cameo Plant Stand

89157 / Cameo Brown / 6 per case

French Country Scroll

Cameo Plant Stands



20 in. Woven Plant Stand

6 per case

86601 / Black

23 in. Scroll Plant Stand

6 per case

83373 / Black

15 in. Aztec Plant Stand

6 per case

86782 / Rust Finish

20 in. Aztec Plant Stand

6 per case

86784 / Rust Finish

Other Various Styles

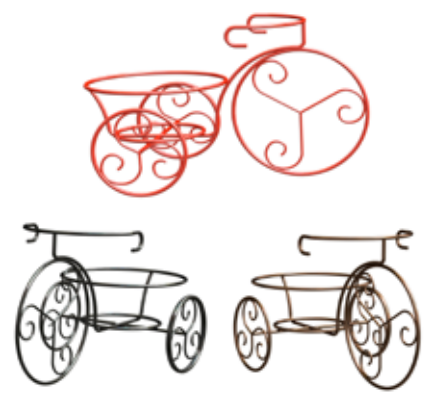
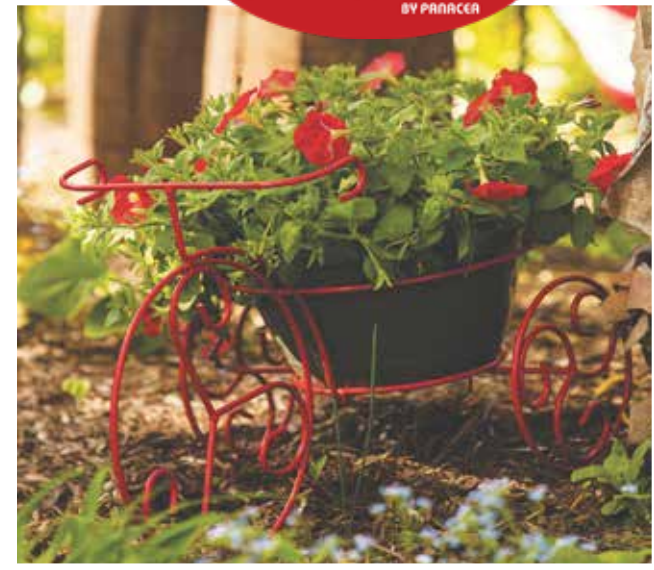

Homeland Tricycle Plant Stand

All 2 per case. Planter holds 12" dia. pot, not included.

86672 / Black
86673 / Oil Rubbed Bronze
86674 / Red

Product Dimensions:
15.5 in H, holds 12 in. diameter pot.



Homeland Park Bench Plant Stand

86680 / Oil Rubbed Bronze / 2 per case
--

Product Dimensions:
21 in. W x 22.5 in. H x 13 in. D

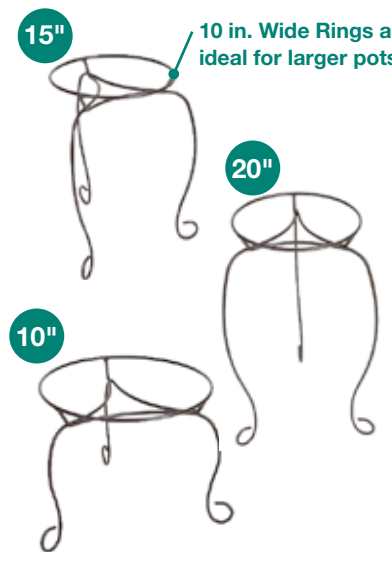

Homeland Plant Stand

All with oil rubbed bronze finish. All 6 per case.

86750 / Wide Ring / 10 in. H
86755 / 15 in. H
86760 / 20 in. H



Homeland Heart Chair Plant Stand

Planter holds 10" dia. pot, not included. Oil Rubbed Bronze finish

86682 / 4 per case



3-Tier Folding Plant Stands

Always a Winner!

Our three-tier folding plant stands are the most popular format. Be sure to include several styles in your merchandising assortment.

Each 3-tier plant stand is individually boxed, 1 per case for easy merchandising and eCommerce.



Features Full-Color Packaging



Hammered Copper Finish for a Rustic Contemporary Appearance



Mission Collection
3-Tier Folding Plant Stand



Classic Finial
3-Tier Plant Stand



Copper Finish

Gun Metal Finish



21"

Mission Collection 3-Tier Folding Plant Stand

Packaged in full color box.

81635 / Black / 1 per case

Product Dimensions:
23 in. W x 21 in. H x 23 in. D

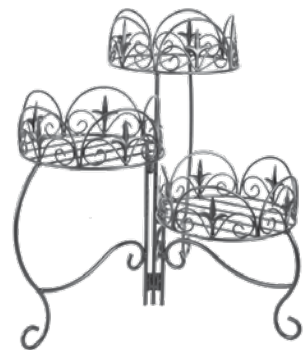

21.5"

Classic Finial 3-Tier Folding Plant Stand

Packaged in color box.

89179 / Black / 1 per case

Product Dimensions:
20.8 in. W x 21.5 in. H x 22.5 in. D



20"

Contemporary Plant Stands

Black finish

86715 / 3-Tier Folding / 1 per case



21.5"

Scroll & Ivy Plant Stands

Black / Brushed Bronze finish

89173 / 3-Tier Folding / 1 per case



Contemporary
3-Tier Plant Stand



Scroll & Ivy
3-Tier Plant Stand

See our matching single, double, and other plant stand shapes on page 58.

Our Popular Classic **Finial, Scroll, & Contemporary** Plant Stands in Multiple Sizes and Formats

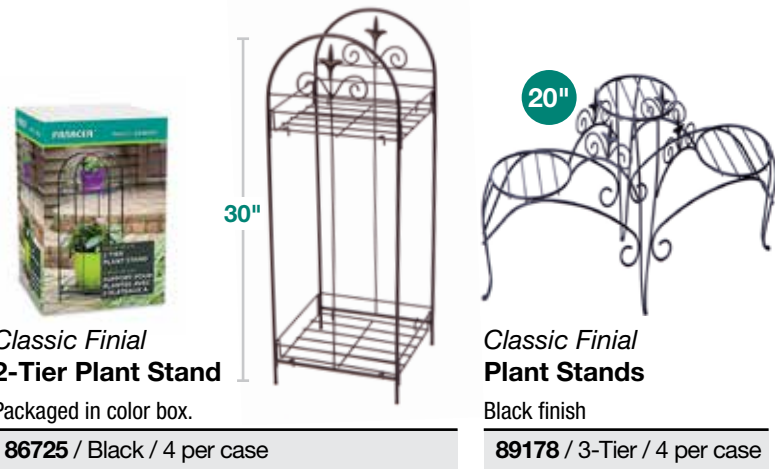

**Classic Finial
2-Tier Plant Stand**

Packaged in color box.
86725 / Black / 4 per case

**Classic Finial
Plant Stands**

Black finish
89178 / 3-Tier / 4 per case

Product Dimensions: 11 in. W x 30 in. H x 11 in. D

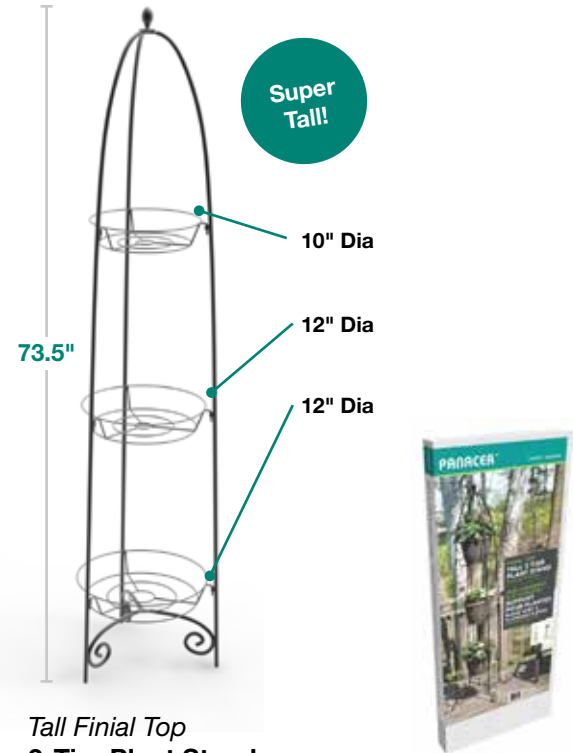

**Tall Finial Top
3-Tier Plant Stand**

86740 / Black / 1 per case

Product Dimensions:
14 in. W x 73.5 in. H x 14 in. D

Three-Tier Finial

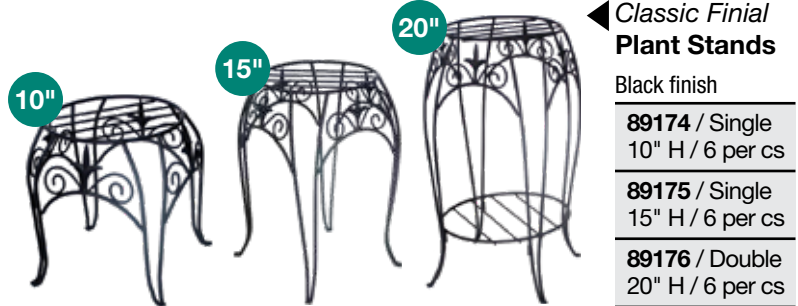

Classic Finial

**Classic Finial
Plant Stands**

Black finish
**89174 / Single
10" H / 6 per cs**
**89175 / Single
15" H / 6 per cs**
**89176 / Double
20" H / 6 per cs**

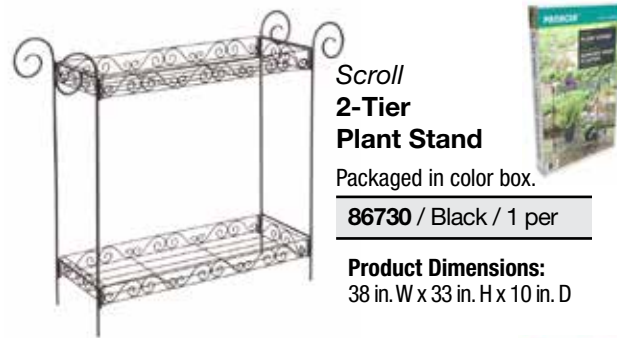

**Scroll
2-Tier
Plant Stand**

Packaged in color box.
86730 / Black / 1 per

Product Dimensions:
38 in. W x 33 in. H x 10 in. D



**Contemporary
2-Tier Tray
Plant Stand**

Packaged in color box.
86710 / Black / 4 per

Product Dimensions:
33.5 in. W x 32 in. H x 13.5 in. D

Two-Tier



Contemporary

**Contemporary
Plant Stands**

Black finish
**86615 / Single
10.5 in. H / 6 per**
**86617 / Single
15.5 in. H / 6 per**
**86620 / Double
20.5 in. H / 6 per**



Scroll & Ivy

**Scroll & Ivy
Plant Stands**

Black finish
**89170 / Single
11.5 in. H / 6 per**
**89171 / Single
16.5 in. H / 6 per**
**89172 / Double
21.5 in. H / 6 per**



**Classic Finial
2-Tier Plant Stand**



**Contemporary
2-Tier Plant Stand**



**Classic Finial
3-Tier Plant Stand**



**Scroll
2-Tier Plant Stand**



**Tall Finial Top
3-Tier Plant Stand**

[See Our Matching 3-Tier Versions of These Plant Stands on the Previous Page.](#)

Modern, On-Trend Plant Stands

Nesting Plant Stands For Efficient Merchandising

3 Size Set

2 Sizes Available

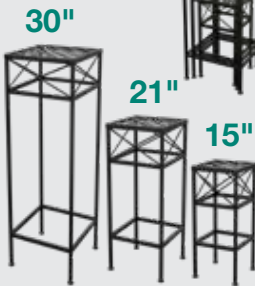

Cross Hatch Square Plant Stand Set

3 size nesting set.

82216 / Matte Black / 1 set per case

Includes 1 each size:
15 in. H / 21 in. H / 30 in. H

Modern Farmhouse Round Wire Basket Plant Stands

2 sizes, black finish. Each size nests together.

81440 / 20 in. H / 4 per case
Product Dim: 11.4 in. W x 20 in. H x 11.4 in. D

82213 / 24 in. H / 4 per case
Product Dim: 11.4 in. W x 24 in. H x 11.4 in. D

Removable Top for storage area underneath



New Age Double Plant Stand

Stylish mesh with embossed banding.

82210 / Black / 4 per case

Product Dimensions:
12 in. W x 20 in. H x 12 in. D



Modern Farmhouse Milk Crate Basket Bin

With removable metal top.

82214 / Matte Black / 4 per case

Product Dimensions:
14 in. W x 15.5 in. H x 14 in. D



Cross Hatch Square Plant Stand Set



Modern Farmhouse Round Wire Basket Plant Stands

Folding Plant Stands with Tray Tops Protect Floors & Feed Plants



Folding 4-Tier Tower Plant Stand

81011 / Matte Black / 1 per case

Product Dim:
15.5 in. W x 47 in. H x 15.5 in. D



20" H Single Round Plant Stand

81007 / Matte Black / 1 per case

Product Dim:
16 in. W x 20 in. H x 16 in. D



Folding 3-Tier Narrow Step Ladder Plant Stand

81009 / Matte Black / 1 per case

Product Dim:
23.25 in. W x 40 in. H x 15.5 in. D



Great for starting seedlings! When trays are flooded with water, fiber pots can absorb standing water and root-feed seedlings.



New Age Double Plant Stand



Modern Farmhouse Milk Crate Basket Bin

Mid-Century Modern



16" H Mid Century Wire & Bamboo Plant Stand

82211 / 4 per case

Product Dimensions:
12.2 in. W x 16 in. H x 12.2 in. D



Adjustable Pot Holders

In 2 Sizes & Finishes



Adjustable 9" to 12" dia. width feature to achieve a snug fit around pots! (Pots not included)

Mid Century | 7" H (Short) Adjustable Plant Stand/Pot Holder

81001 / Natural Bamboo & Black / 6 per case

Product Dimensions:
7.5 in. W x 7 in. H x 7.5 in. D

Mid Century | 15" H (Tall) Adjustable Plant Stand/Pot Holder

81003 / Natural Bamboo & Black / 6 per case

Product Dimensions:
7.5 in. W x 15 in. H x 7.5 in. D



Includes adjustable width feature to achieve a snug finish against pottery (Pottery not included)



Fully assembled in assorted display carton



Combination Terrarium + Plant Stand

Great for displaying succulents, cacti, bonsai, and miniature gardens – also ideal for fairy gardens!

Urban Gardener Terrarium Plant Stand

A unique combination!

82217 / Black / 1 per case

Product Dimensions: 20 in. H x 12 in. dia.



Packaged in individual Urban Gardener® brand color boxes



Aluminum Plant Stand



WITH MATCHING PLANT CADDY!
See this and more of our plant caddies on page 67.



16" H Aluminum Trellis & Scroll Plant Stand

Optional matching plant caddy sold separately (82215)

82212 / Black / 4 per case

Pedestal Plant Stand

20"



Adds height and interest to a potted plant and stacks nicely for compact storage.

Euro Basic Pedestal Plant Stands

Stacks for compact storage. 4 per case.

83383 / 20 in. H (top dia. 9.75 in. dia.)



Makes a great promo item!



The Look Of Yesteryear

In a Modern-Day Galvanized Format!

With its vintage appeal, this A-frame construction plant stand has details that provide the popular "re-purposed" look of an authentic old metal ladder. Compact and lightweight, yet rugged and strong enough to hold heavy pottery. The three, galvanized metal shelves fit snugly onto the ladder frame and require no tools to assemble while keeping dirt and moisture contained. Perfect indoors or on a small patio. Folds compactly for seasonal storage.

Great for starting seedlings!
When trays are flooded with water fiber pots can absorb standing water and root-feed seedlings

Vintage Ladder
A-Frame Plant Stand

83481 / Aged Galvanized
1 per case

Product Dimensions:
40 in. W x 48 in. H x 12 in. D

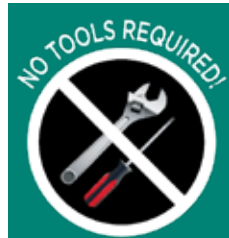

The Vintage Ladder A-Frame and Adjustable Shelf Plant Stands are constructed to require no tools and fold up for compact, seasonal storage!

Scroll Design Accessory Furniture & Plant Stands



A
Forged 3-Tier Plant Stand

Black Finish.
89193 / 1 per case

Product Dimensions:
39 in. W x 41 in. H x 14 in. D



B
Forged Corner Plant Stand

Black Finish.
89194 / 1 per case

Product Dimensions:
14 in. W x 40 in. H x 14 in. D

▲
4 Shelf Folding Baker's Rack Plant Stand

Brushed Bronze Finish.
89197 / 1 per case

Product Dimensions:
36 in. W x 75 in. H x 17 in. D



▲
Potting Bench with Soil Reservoir

89196 / Bronze Finish / 1 per case

Product Dims: 36 in. W x 55.5 in. H x 17 in. D

Three-Piece Nesting Plant Stand Sets

Available In Two Styles: **Scroll & Gothic**



A
Scroll 3-Tier Set Nesting Tables

Set of 3 nesting sizes.
89191 / Brushed Bronze
1 set per case

Small Table:
35.5 in. W x 19 in. H x 11 in. D

Medium Table:
37 in. W x 24 in. H x 11 in. D

Large Table:
39 in. W x 30 in. H x 11 in. D

B
Gothic 3-Tier Nesting Plant Stand Set

Set of 3 nesting sizes.
89192 / Black
1 set per case

Small Plant Stand:
27 in. W x 16 in. H x 10 in. D

Medium Plant Stand:
30 in. W x 22 in. H x 10 in. D

Large Plant Stand:
33 in. W x 27 in. H x 10 in. D



Our first plant stands with adjustable shelving for various plants and multiple sizes of potted plants.



Great for indoor gardening or for starting seeds

Exclusive Adjustable Shelf Plant Stands



Adjustable Folding
4-Tier Baker's Rack Plant Stand

83390 / 1 per case

Product Dims:
38 in. W x 72.5 in. H x 16.75 in. D

Flexibility With Good Looks!



Adjustable Folding
3-Tier Baker's Rack Plant Stand

83391 / 1 per case

Product Dimensions:
38 in. W x 44 in. H x 16.75 in. D



INTRODUCING THE

HEAVY WEIGHT™

PLANT CADDY SERIES

ENGINEERED PERFORMANCE • DESIGNER STYLING

YOUR SOURCE FOR SERIOUSLY **STRONG** MULTI-PURPOSE PLANT CADDIES



Rugged Locking Wheels



No Broken Wheels



Metal Reinforced on top & bottom



Move Heavy, Potted Plants Effortlessly, up to 300lbs!

300 lbs
136 kgs
WEIGHT CAPACITY

**Heavy Weight™
Recycled Plastic**

100% RECYCLED PLASTIC PLANT CADDY

300 lbs
136 kgs
WEIGHT CAPACITY

- Trendy, tread plate slip-proof surface
- Recessed wheel cavities for compact merchandising
- Heavy Weight™ steel-reinforced locking casters

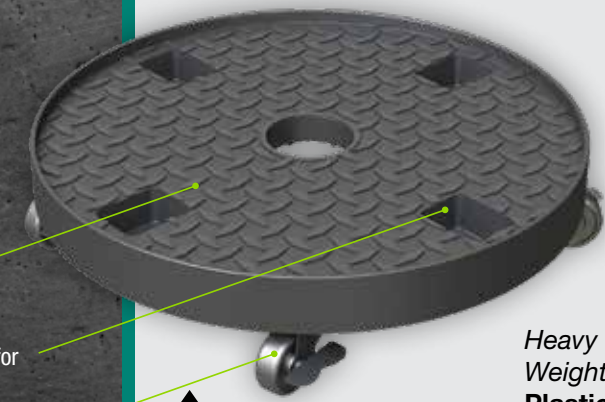

Heavy Weight™ 100% Recycled Plastic Plant Caddy

Reinforced casters & slip-proof surface.

84746 / 14 in. dia. / 6 per case

Heavy Weight™ Plastic Caddy Display

Contains display and 12 of **84746**.

90-90307
12 PC Loaded



Makes a Great Promo Item!

**Heavy Weight™
Industrial Wood**

Sustainably Grown Hardwood Won't Rot

Boxed Square Caddies

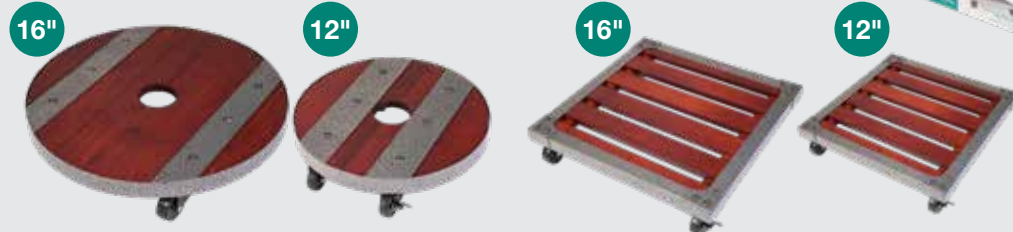

Heavy Weight™ Round Industrial Wood Plant Caddies

Reinforced with metal.

84740 / 12 in. dia. / 4 per case

84741 / 16 in. dia. / 4 per case

Heavy Weight™ Square Industrial Wood Plant Caddies

Reinforced with metal. Boxed in color packaging.

84743 / 12 in. dia. / 4 per case

84744 / 16 in. dia. / 4 per case

Heavy Weight™ Cast Iron
Incredibly Durable!



Heavy Weight™ Round Cast Iron Plant Caddy

Assorted, 2 of each color per case.

84725 / 12 in. dia. / 6 per case

Heavy Weight™ Round Cast Iron Plant Caddy

Assorted, 2 of each color per case.

84726 / 17 in. dia. / 6 per case

Clear Plastic



AVAILABLE IN 3 SIZES!

High Volume, Stock Up!

Clear Plastic Round Economy Plant Caddy

Recessed wheel cavities for compact merchandising.

84730 / 12 in. dia. / 12 per case

84731 / 14 in. dia. / 12 per case

84732 / 16 in. dia. / 8 per case



Plastic & Steel



Brown Cameo Plastic & Steel Plant Caddy

With plastic saucer.

89161 / 14 in. dia. / 6 per case

89160 / 17 in. dia. / 6 per case

Aluminum



Trellis & Scroll Aluminum Plant Caddy

With with matching plant stand available.

82215 / 12 in. dia. / 6 per case



Optional Matching Plant Stand!

See this and more of our plant stands on page 63





Economy
Wood Plant Caddies



Round Slotted
Wood Plant Caddy

84749 / 14 in. dia. / 6 per case



Square Slotted
Wood Plant Caddy

86545 / 14 in. dia. / 4 per case



Metal Forged & Wire

Trivets & Plant Caddies



8"

10"

12"

Forged Pot Trivets

Black

89166 / 8 in. dia. / 6 per case

89165 / 10 in. dia. / per case

89164 / 12 in. dia. / 6 per case

AVAILABLE
**IN 3
 SIZES!**



12"

Wire Caddy

Green

89229 / 12 in. dia. / 6 per case



Heavy Duty
Wire Caddy

Black

89163 / 10 in. dia. / 6 per case

89167 / 13 in. dia. / 6 per case

89168 / 16 in. dia. / 6 per case

AVAILABLE
**IN 3
 SIZES!**

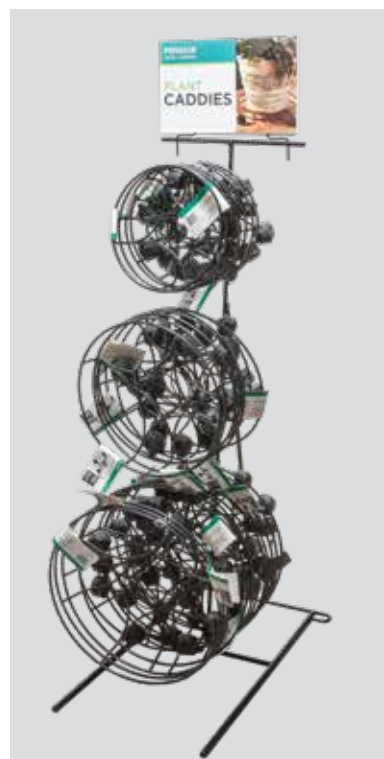

HD Wire Loaded
Plant Caddy Display

Pre-loaded display unit.

90-90175 / 36-PC

Includes 2 cases each of **89163**,
89167, and **89168**.



Designer Plant Caddies



14"

Resin Woven Plant Caddy

Espresso Brown.

84748 / 14 in. dia. / 6 per case



12"

Scroll Tube Plant Caddy

Bronze finish.

86772 / 12 in. dia. / 6 per case



12"

Contemporary Square Plant Caddy

Black finish.

86701 / 12 in. dia. / 6 per case

Basic Shepherd Hooks



Single Shepherd Hook

Single & Double Round Stock

Single Shepherd Hooks
Black finish.

89024 / 36 in. H / 12 pc
89034 / 48 in. H / 10 pc
89003 / 64 in. H / 10 pc
89031 / 84 in. H / 10 pc

Double Shepherd Hooks
Black finish. All 10 per case.

89029 / 64 in. H
89030 / 84 in. H

Double Offset Shepherd Hooks
Black finish. 10 per case.

89032 / 84 in. H



RUGGED MONSTER HOOKS

Heavy Duty Construction
Thick 9/16" Steel keeps hook from bending.
(87985 1/2" Rod)

Deep seated 2 or 3 prong foot for extra stability

50" Single Shepherd Hook	87985 / Bronze / 5 per case
68" Single Shepherd Hook	87965 / Bronze / 5 per case
88" Single Shepherd Hook	87970 / Bronze / 5 per case
88" Double Offset Shepherd Hook	87975 / Bronze / 5 per case
88" Single Shepherd Hook	89141 / Black / 5 per case
88" Single Shepherd Hook	89145 / Black / 5 per case
88" Double Offset Shepherd Hook	89147 / Black / 5 per case

Our Most Rugged & Functional Shepherd Hooks are Proudly Made in the U.S.A.
Show your support for American made products while offering your customers this line of "Monster" Shepherd Hooks that is unmatched for Quality & Ruggedness!

HEAVY DUTY CONSTRUCTION!
Thick 9/16" Steel - To Keep Shepherd Hooks From Bending
Monster Hooks & Homeland™ Products are produced From Solid Steel with a tough powder coated finish.

Shepherd Hooks Merchandising Solutions

We have developed several ways to merchandise Shepherd Hooks ranging from free-standing displays to in-line options. Below is our most popular assortment shown on a c-base. Looking for alternative assortments? Order the below C-base and make your own assortment, or ask your Panacea representative about alternative or custom display options.

Shepherd Hook Round Stock Assortment

Display Number: **89067ASST**

Item#	Description	UPC Number	QTY
89003	64" Single Shepherd's Hook, Black	093432890035	20
89024	36" Single Shepherd's Hook, Black	093432890240	12
89031	84" Single Shepherd's Hook, Black	093432890318	10
89032	84" Single Shepherd's Hook, Offset Black	093432890301	10
89034	48" Single Shepherd's Hook, Black	093432890349	20
89067	Shepherd Hook Display C-Base	093432890677	1
Total number of product pieces on display			72

Our C-Base Display Fixture (shown below) allows you to create your own assortment of shepherd hooks.

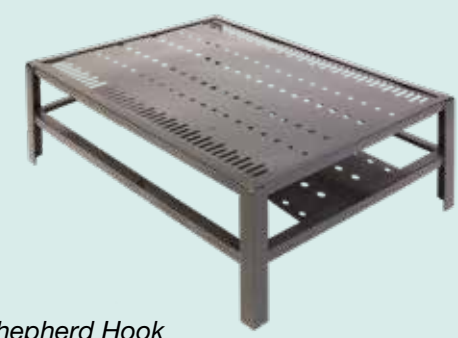

Shepherd Hook Display C-Base
89067 / Black / Empty Display

Boxed Shepherd Hooks

Great For Compact Merchandising & eCommerce

Easy, no-tools assembly. Components are packaged in attractive color boxes.

Promotional Boxed Double	Boxed Deluxe 4-Way Finial	Boxed Rooster Double Weathervane
84690 / 84 in. H Black / 4 per case	84691 / 84 in. H Black / 4 per case	84692 / 84 in. H Rust / 4 per case

Olde World Forged Hooks™ Forged Square-Stock

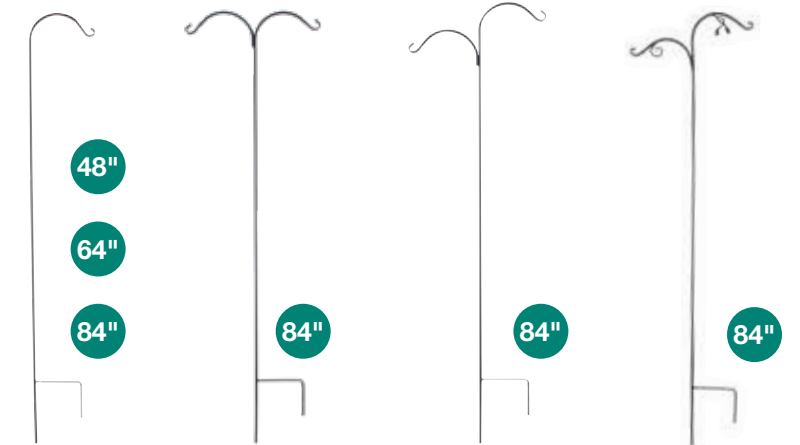

Single Forged Shepherd Hook	Double Forged Shepherd Hook	Double Offset Forged Shepherd Hook	Double Forged Shepherd Hook with Leaves & Vine
Black finish. All 10 per case.	Black finish. 10 per case.	Black finish. 10 per case.	Black finish. 5 per case.
89438 / 48 in. H	89441 / 84 in. H	89442 / 84 in. H	89444 / 84 in. H
89439 / 64 in. H			
89440 / 84 in. H			



See matching Forged Hooks & Brackets on page 80

Display Number: **89973**

Item#	Description	QTY	
89439	64 in. Single Forged Hook	20	
89440	84 in. Single Forged Hook	10	
89442	84 in. Double Offset Forged Hook	10	
89438	48 in. Single Forged Hook	20	
89067	Shepherd Hook Stand	1	
Total number of product pieces on display			60



Forged Square-Stock Assortment (Display # 89973)



Designer Shepherd Hooks

COMBINE FUNCTION & STYLE FOR MORE VARIETY

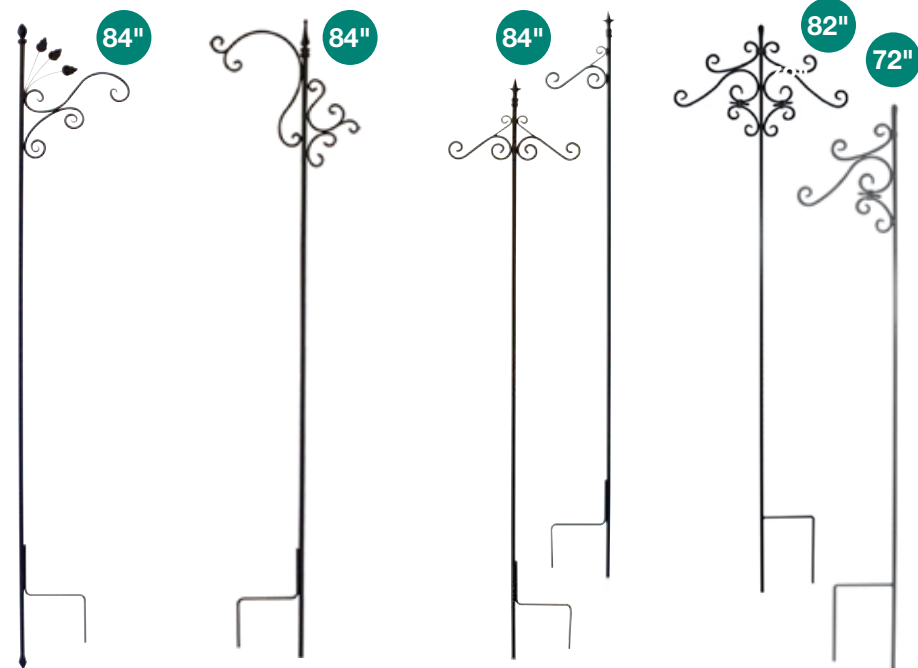

Leaves
Shepherd Hook
89135 / 84 in. H
Black / 5 per case

Teardrop Finial
Shepherd Hook
Black finish.
89136 / 84 in. H
5 per case

Romantic
Shepherd Hooks
Black finish.
89138 / Single
84 in. H / 5 per case
89139 / Double
84 in. H / 5 per case

Fleur-De-Lys
Shepherd Hook
Black finish.
88722 / Single
72 in. H / 4 per case
88721 / Double
82 in. H / 4 per case

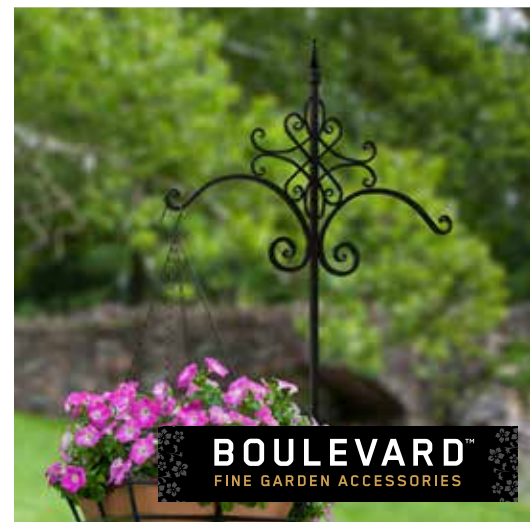

SEE MORE MATCHING COLLECTION ACCESSORIES THROUGHOUT THIS CATALOG

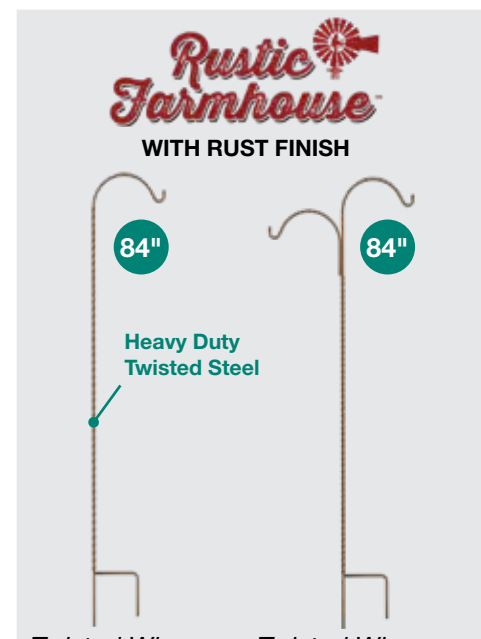
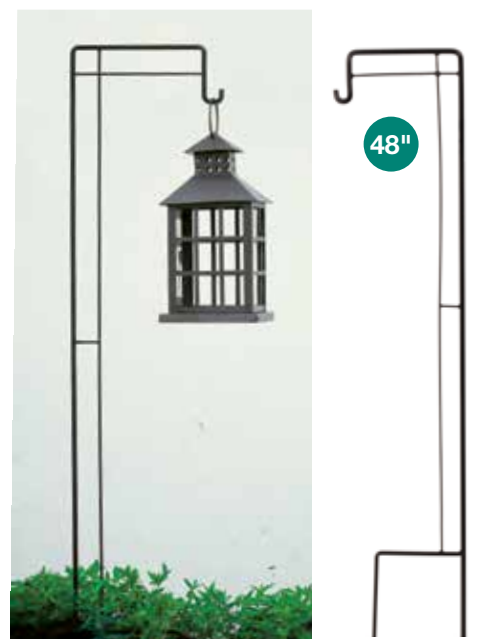

Contemporary
Shepherd Hook
Black finish.
87960 / 48 in. H / 5 per case

Twisted Wire
Single Shepherd Hook
89129 / Rust finish
84 in. H / 5 per case

Twisted Wire
Double Offset Shepherd Hook
89130 / Rust finish
84 in. H / 5 per case



French Country
Double Offset Shepherd Hook
84640
Distressed White
48 in. H / 5 per case

Twisted Wire
Double Offset Shepherd Hook
84645
Distressed White
72 in. H / 5 per case

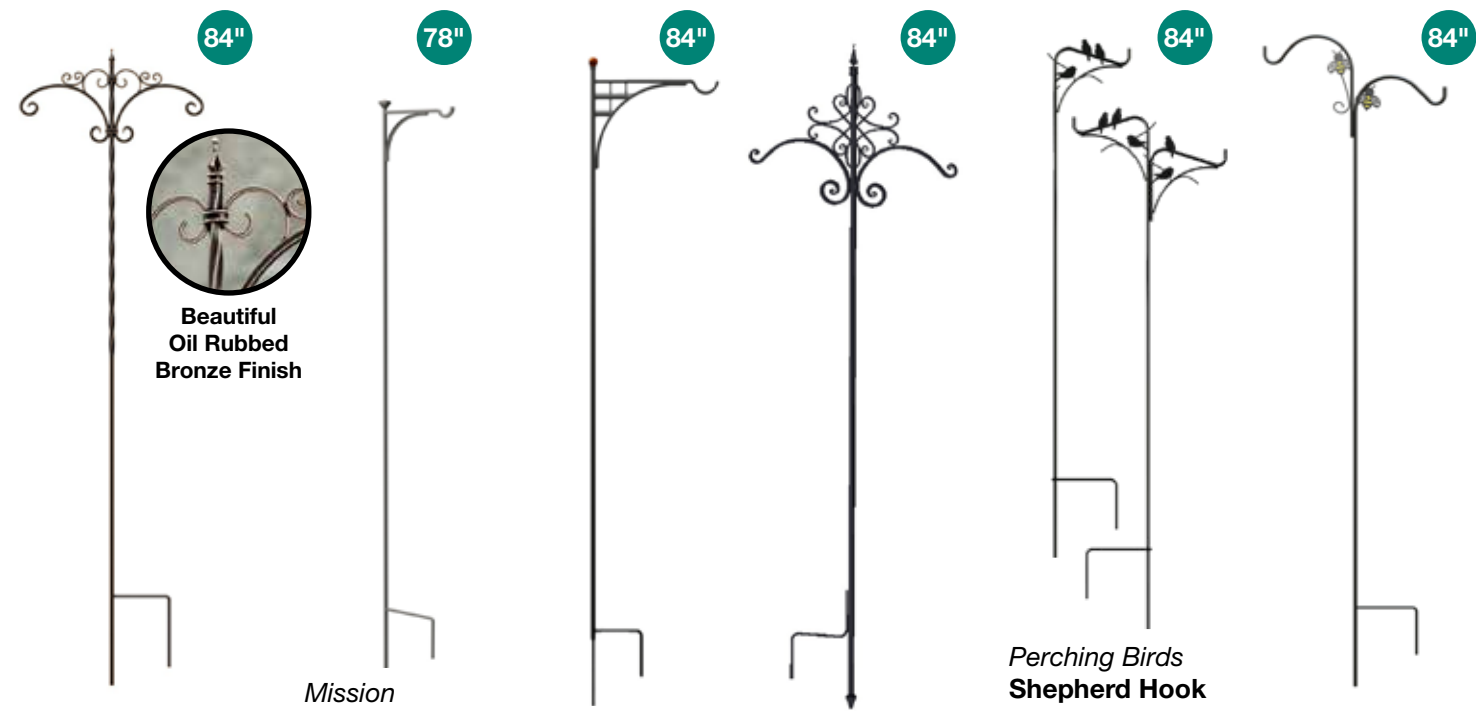

Rustic Italia
Double Shepherd Hook
84689 / 84 in. H
Bronze / 5 per case

Mission
Collection Shepherd Hook
Black finish.
82170 / 78 in. H
5 per case

Modern
Farmhouse Shepherd Hook
81434 / 84 in. H
Black / 5 per case

Boulevard™
Double Offset Shepherd Hook
84630 / 84 in. H
Black / 5 per case

Perching Birds
Shepherd Hook
Black finish.
86910 / Single
84 in. H / 5 per case
86912 / Double
84 in. H / 5 per case

Bee-Conscious
Double Offset Shepherd Hook
81453 / 84 in. H
Black / 5 per case

Specialty Shepherd Hooks



THE BEAST™ Our Strongest Shepherd Hook

Rugged Construction!

Great For Heavier:

- Hanging Baskets – Up to 16 inch diameter
- Bird Feeders
- Wind chimes & More

Decorative ball finish piece

Super tall - 90in/ 228cm

1 in./ 2.54cm thick tubular steel to support heavy hanging baskets and bird feeders.

Quad foot stabilizer

Rugged auger foot keeps shepherd hook from coming ungrounded

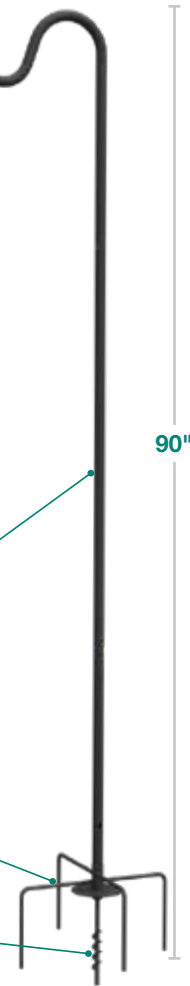

Boxed "The Beast"
1" Tubular Steel
Shepherd Hook

84628 / 90 in. H (228cm)
Black Finish / 1 per case



Individually boxed in KD format (under 48") for convenient, compact merchandising & eCommerce use.

Weathervane Shepherd Hooks

These 78 inch shepherd hooks include a directional weathervane with decorative stampings and a trendy rust finish. Tops can be easily removed for quick transportation from the store.



ROOSTER WEATHERVANE
Now available as an obelisk!

Rooster Weather Vane

86806 / 72 in. H
Rust / 1 per case



Rooster Weather Vane Shepherd Hook

84680 / 78 in. H
Rust / 4 per case



Armillary Weather Vane Shepherd Hook

84683 / 78 in. H
Rust / 4 per case



Perching Birds Weather Vane Shepherd Hook

84682 / 78 in. H
Rust / 4 per case



Welcome House Weather Vane Shepherd Hook

84681 / 78 in. H
Rust / 4 per case



Each design varies in overall height. The list height of 78 inches is measured from the bottom of the shepherd hook to the top of the hook BEFORE the decorative weathervane top.

Weather Vane Shepherd Hook Display

Holds 20 weathervane shepherd hooks, choose your own assortment.

90-90281EM / EMPTY



SEE MORE BASKET HANGERS ON PAGE 39

84"

4-Sided Finial Shepherd Hook
89447 / 84 in. H
Black / 4 per case

72"

Inside Curl Shepherd Hook
88735 / 72 in. H
Black / 4 per case

64"

84"

Inside Curl Bird Shepherd Hook
Green finish. 10 per case.
89109 / 64 in. H
89111 / 84 in. H

84"

84" H Flag Holder
*Flag not included.
84670 / 84 in. H
10 per case

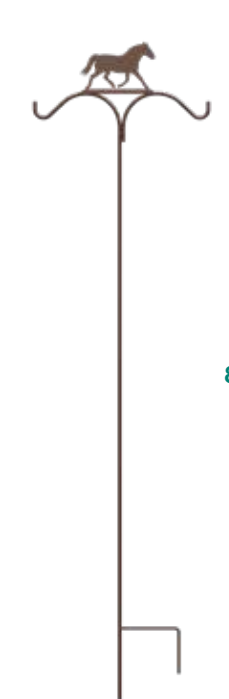

Assorted Farm Animal Shepherd Hooks

84" H
Assorted Farm Animal Double Shepherd Hook

Mixed assortment – 1 of each animal.

84633 / Rust Finish / 5 per case

These Farm Animal Shepherd Hooks can be displayed on our standard C-base fixture.

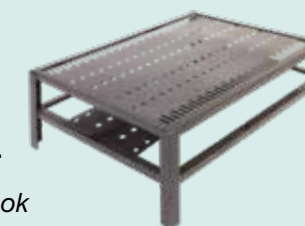

Shepherd Hook Display C-Base

89067 / Black / Empty Display

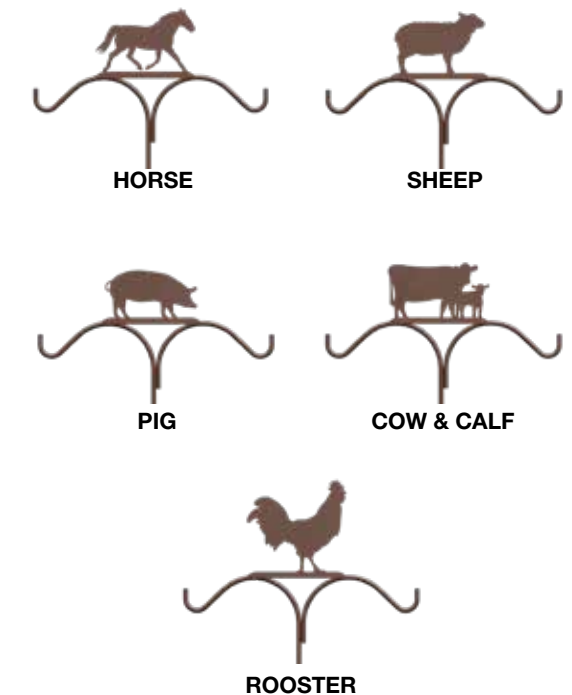

ROOSTER

Specialty Hooks & Brackets

For Deck, Rail, & Wall



Adjustable Deck Hooks

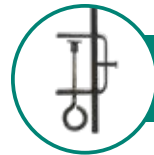

Deck hooks use adjustable clamp

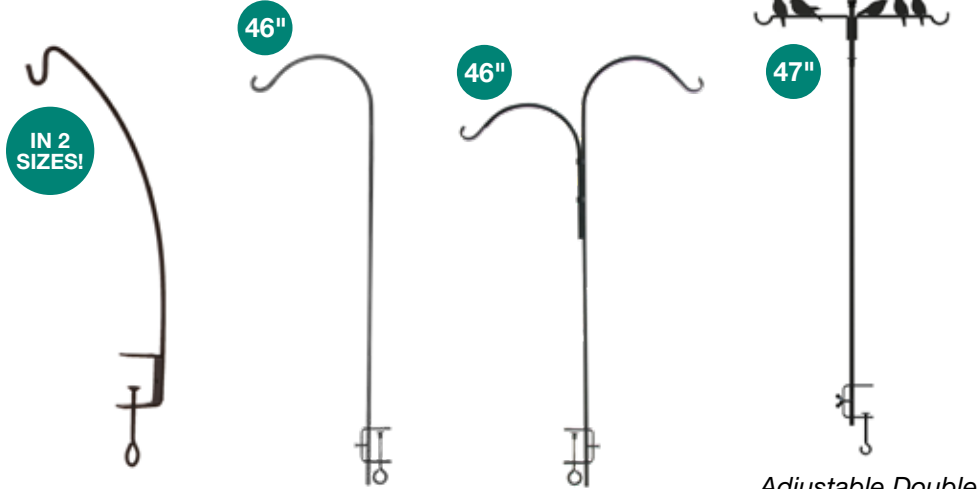

Adjustable Angled Deck Hook Black finish. All 6 per case. 83035 / 24 in. H 83040 / 36 in. H	Adjustable Single Deck Hook Black finish. 89042 / 46 in. H 5 per case	Adjustable Offset Forged Deck Hook Black finish. 89434 / 46 in. H 6 per case	Adjustable Double Perching Birds Deck Hook Black finish. 83116 / 47 in. H 4 per case
---	---	--	--

Mounted Deck & Wall Hooks

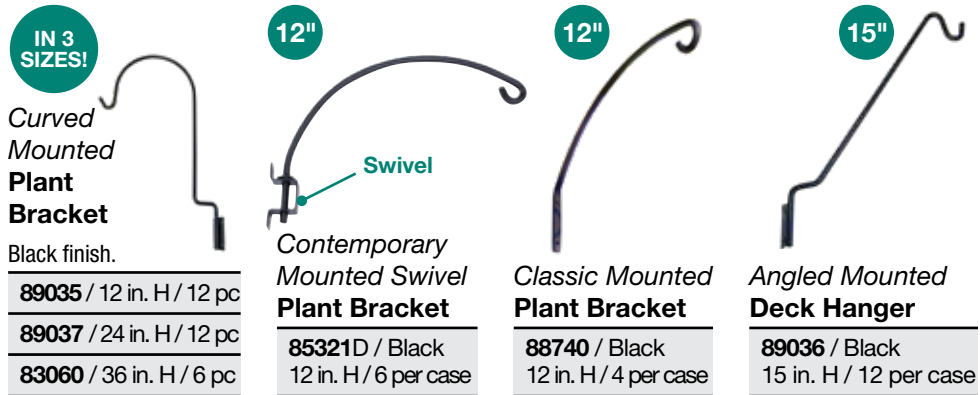

Curved Mounted Plant Bracket Black finish. 89035 / 12 in. H / 12 pc 89037 / 24 in. H / 12 pc 83060 / 36 in. H / 6 pc	Contemporary Mounted Swivel Plant Bracket 85321D / Black 12 in. H / 6 per case	Classic Mounted Plant Bracket 88740 / Black 12 in. H / 4 per case	Angled Mounted Deck Hanger 89036 / Black 15 in. H / 12 per case
---	---	--	--

"S" Hooks

Extender "S" Hook All 12 per case. 2 pieces per pack. 86502 / White 86501 / Black	Galvanized "S" Hooks All 24 per case. 86255 / 6 in. 86256 / 12 in. 86257 / 18 in.
--	--

Garden S-Hooks All 12 per case. 89011 / 4 in. Black / 2-pieces 89012 / 6 in. Black / 2-pieces 89013 / 8 in. Black / 2-pieces 86215 / 12 in. Black / Singles	86216 / 12 in. White / Singles 89015 / 18 in. Black / Singles 89016 / 24 in. Black / Singles Special Packaging: 89014D / 12 in. Black / 2 pieces on backer cards in display carton
---	---

Brilliant Color S-Hooks All 24 per case. Assorted Electric Blue, Emerald Green, Ruby Red & Lightning Purple. 86251 / 12 in. 86252 / 18 in.	Vibrant Color S-Hooks All 24 per case. Assorted Blue, Light Green, Red & Yellow. 86253 / 12 in. 86254 / 18 in.
--	--

Single Flower Pot Brackets

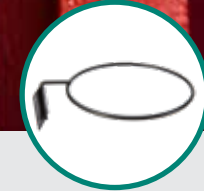

Wall Mount Flower Pot Holder 89055 / Black / 12 per case / Holds 8-10 in. Pot 89066 / Black / 12 per case / Holds 6 in. Pot
--



8" Over-the-Rail Pot Holder Holds up to a 8" flower pot. 89045 / Black / 6 per case
--



Over-the-Deck Adjustable Pot Holder Holds up to a 8" flower pot. 89049 / Black / 6 per case
--



Rectangular Flower Box Brackets Aluminum Wall Mount Bracket Each bracket is 7 In. W. x 4 In. H. 89059 / 12 per case



Adjustable Aluminum Deck Mount Bracket Each bracket is 12 In. W. x 3.375 In. H. 89057 / Black / 12 per case
--



Aluminum Fence / Rail Mount Bracket Each bracket is 11 In. W. x 4.375 In. H. 89058 / Black / 12 per case

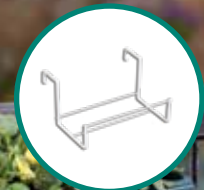

Adjustable Deck Flower Box Holder For flower boxes up to 8 inches deep. 89053 / White / 6 per case 89054 / Black / 6 per case

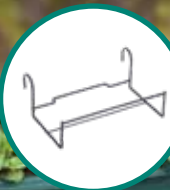

Over-the-Rail Flower Box Holder For flower boxes up to 8 inches deep. 89043 / Black / 6 per case 89044 / White / 6 per case



Basic Plant Hooks, Brackets & Chains



Contemporary Plant Bracket
All 6 per case.

85221D / 12 in. / Black
85251D / 15 in. / Black
85252D / 15 in. / White



Curved Plant Bracket

85061D / Black 6 in. / 6 per case



Plant Bracket
All 6 per case. 6" Width

85161D / Black
85162D / White



Ceiling Hooks



Swivel Ceiling Hook
All 6 per case.
1 piece per pack.

86131 / Black
86132 / White



Jumbo Ceiling Hook
All 6 per case.
1 piece per pack.

86121 / Black
86122 / White
86125 / Brass
86125AB / Antique Brass



Swag Hook
All 6 per case.
2 pieces per pack.

86101 / Black
86102 / White
86105 / Brass



Ceiling Hook
All 12 per case.
5 pieces per pack.

86201 / Black
86202 / White
86205 / Brass



2 in. Vinyl Ceiling Hook
All 6 per case.
3 pieces per pack.

86206 / Black
86207 / White



Ceiling Track Hooks
All 6 per case.
2 piece pack except where noted.

86304 / Clear
86303 / White 6 piece pack
86302 / White

Chains



18 in. Flower Pot Chain
All 6 per case.

86411 / Black
86412 / White
86415 / Brass



36 in. Extender Chain
All 6 per case.

86401 / Black
86402 / White
86405 / Brass

Decorative Plant Hooks & Brackets

Steel Plant Brackets

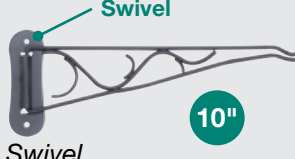

Swivel Plant Bracket
All 12 per case. 10" width.

85401 / Black
85402 / White



Glass Accent Forged Plant Bracket
15 in. / 6 per case

85041 / Black



Cast Aluminum Plant Brackets



Victorian Scroll Plant Bracket
14 in. / 6 per case

85014 / Off White



Leaves Plant Bracket
9 in. / 6 per case

85008 / Off White



Hummingbird Plant Bracket
8 in. / 6 per case

85004 / Sand



Colonial Plant Bracket
12 in. / 6 per case

85621 / White



Butterfly Plant Bracket
15 in. / 6 per case

85040 / Chocolate Brown



Flowers Plant Bracket
9 in. / 6 per case

85643 / Brushed Gold



Butterfly Plant Bracket
9 in. / 6 per case

85640 / Brushed Bronze



Scroll Plant Bracket
6 in. / 6 per case

85635 / Brushed Bronze

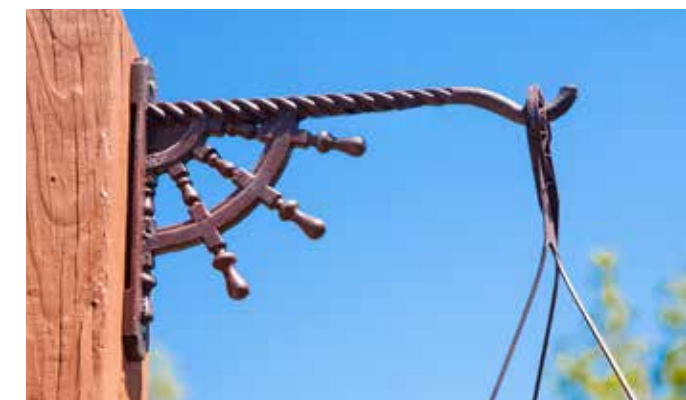

Boat Yard Plant Bracket
All 6 per case. Bronze finish.

83453 / Sea Salt Rust / 12 in. / 4 per case



Plant Bracket
All 6 per case. Bronze finish.

85622 / 9 in.
85721 / 12 in.



Vine Plant Bracket
4 in. / 6 per case

85626 / Brushed Bronze

In 3 Sizes – Black Or White
Classic
Timeless Design

Plant Bracket
All 6 per case

9"	85591D / 9 in. / Black
	85592D / 9 in. / White
12"	85521D / 12 in. / Black
	85522D / 12 in. / White
15"	85551D / 15 in. / Black
	85552D / 15 in. / White







Looking for More Hooks & Brackets?

Ask your Panacea representative for our HOOKERY Catalog.



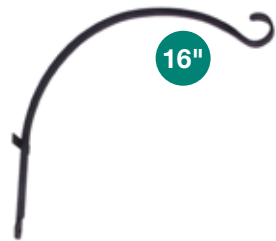

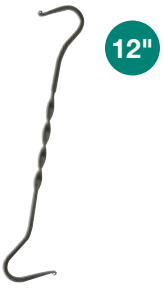

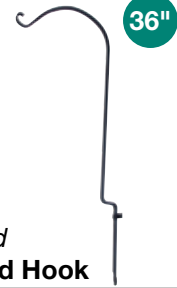





Its full of great-selling, Hookery-branded products including more shepherd hooks, brackets, & displays.

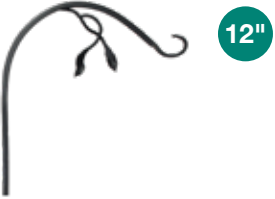

Hooks & Brackets

 16" <i>Forged</i> Curved Hook 89416 / 16 in. / 12 per case	 3" "J" Hook with Screw 89403 / 3 in. / 24 per case	 6" Threaded "J" Hook 89404 / 6 in. / 24 per case
 12" <i>Forged</i> Extender Hook 85752D / 12 in. / 12 per case	 8" Double "J" Hook 89409 / 8 in. / 24 per case	 36" <i>Forged</i> Curved Hook 89436 / 36 in. / 12 per case Product Dims: 12 in. W x 36 in. H



 15" <i>Forged</i> Straight Hook 89415 / 15 in. / 12 per case	 10" <i>Forged</i> Straight Hook 89410 / 10 in. / 12 per case	 6" <i>Forged</i> Straight Hook 89406 / 6 in. / 12 per case	 10" <i>Forged</i> Ball & Hook Bracket 89421 / 10 in. / 6 per case
 12" <i>Forged</i> Leaf & Vine Bracket 89420 / 12 in. / 6 per case	 12" <i>Forged</i> Vine Bracket 89422 / 12 in. / 6 per case	 7" <i>Forged</i> Curved Hook 89407 / 7 in. / 12 per case	 8" <i>Forged</i> Curved Hook 89408 / 8 in. / 12 per case
 12" <i>Forged</i> Curved Hook 89411 / 12 in. / 12 per case	 12" <i>Forged</i> Angles Hook 89412 / 12 in. / 12 per case	 5" <i>Forged</i> Angle Hook 89405 / 5 in. / 12 per case	 6" <i>Forged</i> "S" Hook 85755 / 6 in. / 12 per case

Tin Punch Metal Rustic Wall Decor

These rustic, 11x17, three-dimensional, pre-galvanized sheet metal plates are powder coated with a textured two-tone rust finish, then packaged in colorful, rustic shelf-ready window cartons. Beautiful indoors and out!

Garden Greetings Wall Decor

Assorted metal laser engraved garden wall decor.

82690 / Rust Finish / 4 per case

Product Dimensions:
11 in. W x 17 in. H

Botanical Design Wall Decor

Assorted metal laser engraved botanical wall decor.

82692 / Rust Finish / 4 per case

Product Dimensions:
11 in. W x 17 in. H



Each Tin Wall Art Design is individually packaged.



Garden Greetings

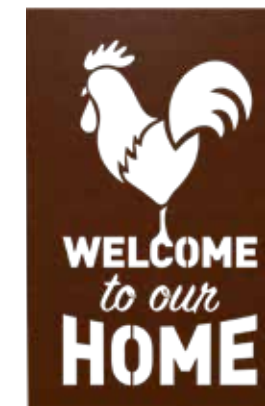

Welcome to our Home



You Are My Sunshine



Life Begins...



Every Little Thing...

Botanical



Fern Leaf



Blowing Seeds



Poppies



Pine Cones



Hanging Bird Baths
Mosaic Glass
Birdbath with Chain

Bird Baths

Rainbow

Multi-Color Blue **Purple/Blue**

Mosaic
Glass Bird Baths with Folding Stands
Includes 1 of each color.
82920 / 3 per case

Product Dimensions:
16 in. Dia. x 21.5 in. H

Stand Height: 21.5" H

Boxed with Metal Stands

Peacock

16 in. Peacock Glass Bird Bath with Stand
Easy assembly!
82905 / 2 per case

Product Dimensions:
16 in. dia. x 21.5 in. H

Red Poppy

16 in. Red Poppy Glass Bird Bath with Stand
Easy assembly!
82906 / 2 per case

Product Dimensions:
16 in. dia. x 21.5 in. H



Yard Stake Bird Baths

ASSORTED SWIRL MOTIF
2-PER CASE (1 EACH COLOR)

Blue Green Swirl **Yellow Orange Swirl**

8" Swirl Glass Bird Baths with Yard Stakes
Includes 2 of each color.
82900 / 4 per case

Product Dimensions:
8 in. Dia. x 18.5 in. H

Assorted Flower Motifs, 1 each style

- Sunflower
- Pink Chrysanthemum
- White Magnolia

Quality Branding & Packaging!

14 in. Assorted Flowers Glass Bird Bath with Stand
Easy assembly!
82902 / 3 per case

Product Dimensions: 14 in. dia. x 17.5 in. H

11" Mosaic Glass Bird Baths with Chain
Includes 1 of each color.
82921 / 2 per case

Product Dimensions:
11 in. Dia. x 14 in. H

Multi-color Blue **Multi-color Red**

Includes compact color box with two assorted color options

Add A Trendy, Farm House Appeal To Your Garden!

Assorted Colors Birdbath with Chain

Chain length 14 inches

Cobalt Blue **Pink**

Purple **Yellow**

10" Assorted Colors Hanging Glass Birdbath with Chain
Includes 1 of each color.
82901 / 4 per case

Product Dimensions:
10 in. Dia. x 14 in. H

ASSORTED FLOWER MOTIF
2-PER CASE (1 EACH COLOR)

Sunflower **Blue Wild Flower**

10" Assorted Flowers Glass Bird Baths with Yard Stakes
Includes 2 of each color.
82912 / 4 per case

Product Dimensions:
10 in. Dia. x 26 in. H

Vintage Galvanized Metal Bird Bath

Vintage GALVANIZED METAL BIRDBATH WITH STAND

Ancien METAL GALVANISE BAIN D'OISEAU RESISTE

Packaged in box with color label

Vintage Galvanized Metal Bird Bath
82930 / 4 per case

Product Dimensions:
18 in. dia. x 19 in. H



Bird Feeding Hooks

BASIC

birding basics

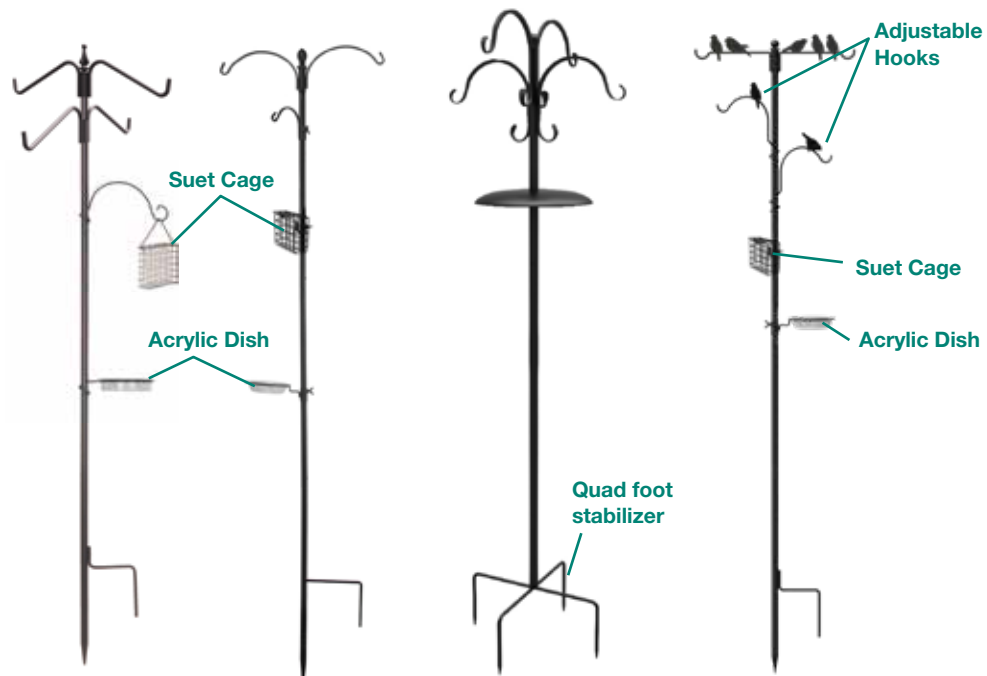

85" H Finial 4-Way Multi-Hook Bird Feeding Station

Includes double hooks, 2 adjustable hooks, suet cage, and acrylic dish.

82940 / Black
1 per case

85" H Basic 2-Way Bird Station

Includes 1 small hanger, 1 suet cage, and 1 water tray.

89143 / Black
1 per case

90" H Deluxe 4-Way Bird Station

Includes metal squirrel baffle, and 4-way hooks.

83170 / Black
1 per case

THE PERCHING BIRDS COLLECTION

85" H Perching Birds 4-Way Feeding Station

Includes double hooks, 2 adjustable hooks, suet cage, and acrylic dish.

83115 / Black / 4 per case

DELUXE



CLEANING ACCESSORIES



Bristle Head Cleaning Brush

83010 / Black / 12 per case

Foam Head Cleaning Brush

83015 / Black / 12 per case

Branch Hooks

12"



Forged "S" Branch Hook

83100 / 12 in. H
Black / 12 per case

24"

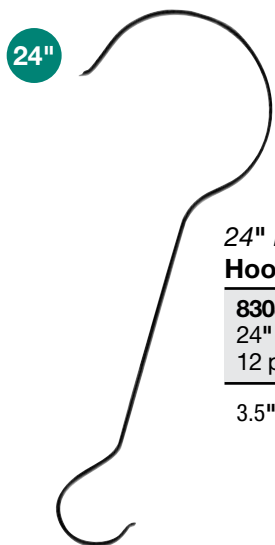

24" H Birdfeeder Hook

83080
24" H / Black
12 per case

3.5" & 7.5" openings

52"

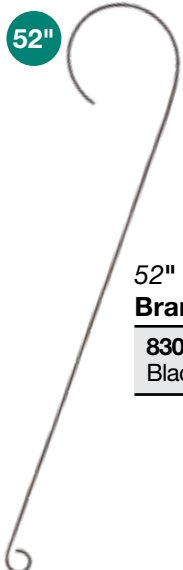

52" H Branch Hook

83090 / 52" H
Black / 12 per case



A PANACEA EXCLUSIVE!

10 Piece Garden Arbor & Bird Feeding Station

birding basics

Arbor + Feeding Station

10 PC Garden Arbor & Bird Feeding Station

83145 / 1 per case

Description	QTY
84" Arbor With Bird Motif Trellis Sides	1
"S" Hooks (4 Sizes: 6", 8", 10", & 12") For Hanging Feeders Of Various Sizes & Styles	4
Fruit Stake Feeder Hook	1
Seed Cylinder/Corn Cobb Feeder Hook	1
Acrylic Bird Bath	1
Mealworm Feeder With Mesh Bottom	1
Suet Feeder	1
Total number of pieces	10

Includes Attractive Color Box



Looking For More Bird & Nature Products?

Ask your Panacea representative for our Bird & Nature Full Line Catalog. It's full of many quality & innovative birding products and respected brands like Audubon® and WoodLink®.

Elegant Rugged Steel Garden Arbors



*Quatrefoil
Scroll Arbor*

89097 / Black
1 per case

Product Dimensions:
43.5 in. W x 90 in. H x 18 in. D

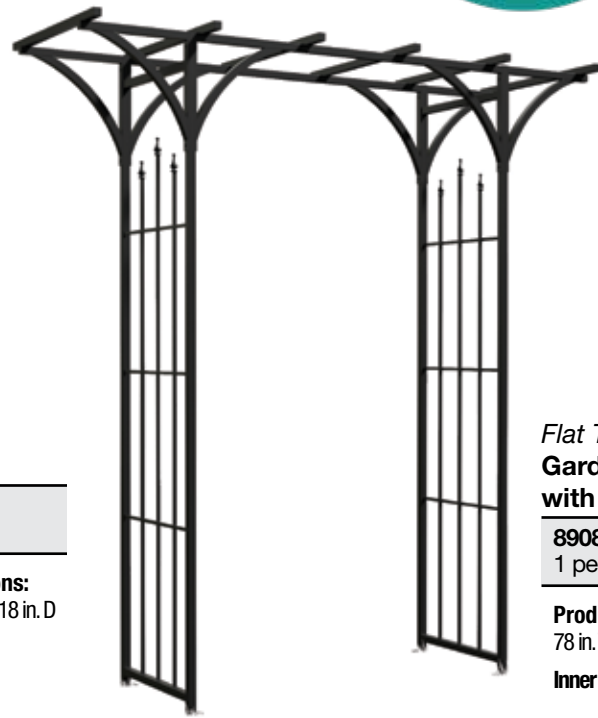

*Flat Top
Garden Arbor
with Finials*

89088 / Black
1 per case

Product Dimensions:
78 in. W x 83 in. H x 26 in. D
Inner Arch: 48 in. W



*Mission
Arch with Lanterns*

84303 / Black / 1 per case

Product Dimensions:
52 in. W x 78 in. H x 16 in. D



*Arched Top
Garden Arbor with Gate*

89096 / Brushed Bronze
1 per case

Product Dimensions:
50 in. W x 90 in. H x 18 in. D



*Scroll
Garden Arbor*

84326 / With Gate
1 per case

84328 / Without Gates
1 per case

Product Dimensions:
39 in. W x 90 in. H x 15 in. D

Available with or
without Gate

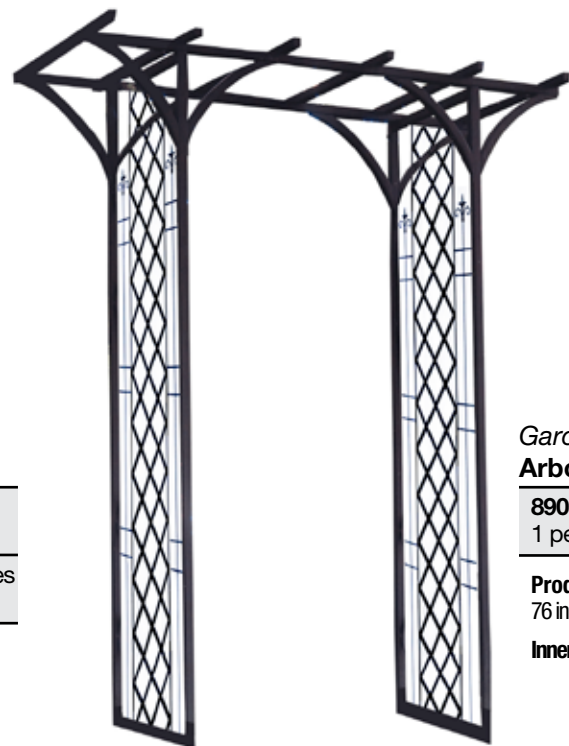

*Garden
Arbor with Lattice*

89089 / Black
1 per case

Product Dimensions:
76 in. W x 84 in. H x 26 in. D
Inner Arch: 48 in. W



*Garden
Arbor with Vines*

89087 / Black / 1 per case

Product Dimensions:
76 in. W x 84 in. H x 26 in. D
Inner Arch: 48 in. W

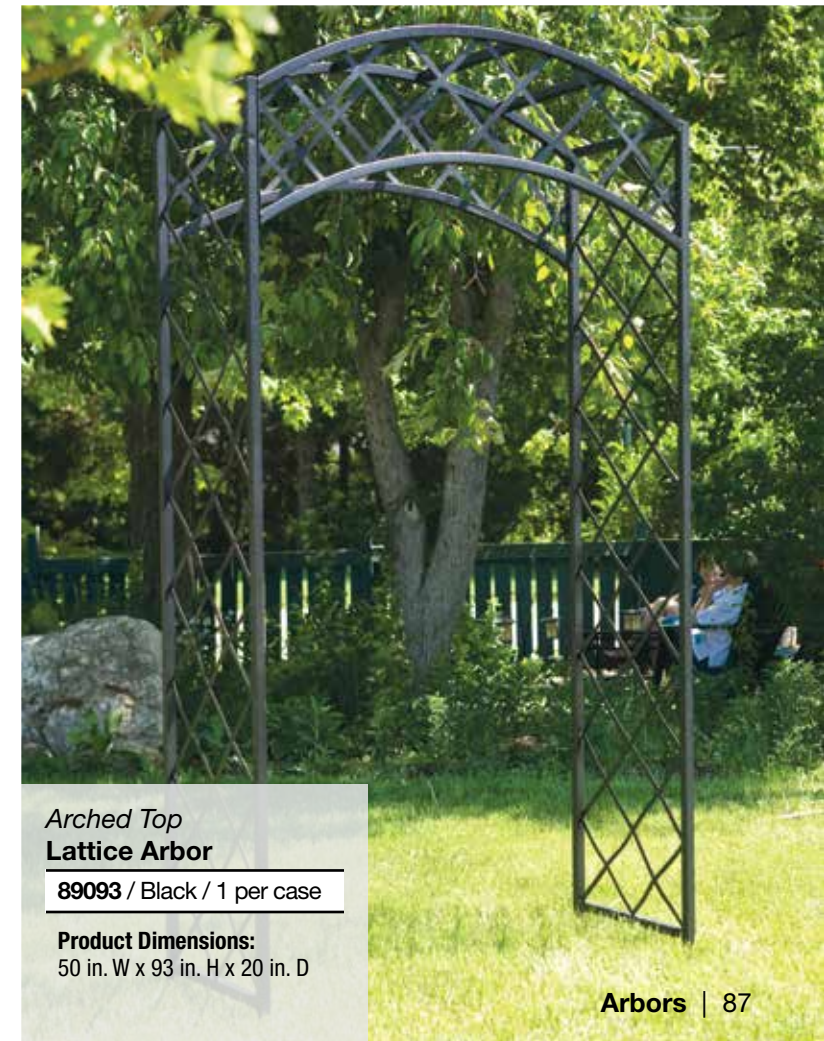

*Arched Top
Lattice Arbor*

89093 / Black / 1 per case

Product Dimensions:
50 in. W x 93 in. H x 20 in. D

Large Garden & Sectional Fence

Reminiscent of classic, vintage wrought iron fencing, our sectional and large metal fence panels include components to create an easy, do-it-yourself beautiful fence system.



Sectional fence looks great with arbors too!
Shown with Flat Top Garden Arbor # 89088 on pg. 87.



Scroll & Finial Garden Fence

87405 / Black
12 per case

Product Dims:
31 in. H x 24 in. W



Triple Arch Garden Fence

87401 / Black
12 per case

Product Dims:
31 in. H x 24 in. W



PROUDLY MADE IN THE USA

MADE IN AMERICA
HOMELAND GARDEN COLLECTION

Homeland Double Arch Garden Fence

87675 / Bronze / 5 per case

Product Dims:
36 in. H x 42 in. W



1. Set



2. Align



3. Drive



Sectional Fence: 3 Classic Styles

GREAT Sectional Displays!

In 3 Styles:

87238 ARCHED FINIAL DISPLAY (SHOWN)

Arched Finial

Garden Fence Post 60pcs - 87299
Arched Finial Section 40pcs - 87230
Arched Finial Gate 3 pcs - 87231
Arched Finial End Panel 6 pcs - 87232

87108 CLASSIC FINIAL DISPLAY

Classic Finial

Garden Fence Post 60pcs - 87102
Classic Finial Section 40pcs - 87103
Classic Finial Gate 3 pcs - 87104
Classic Finial End Panel 6 pcs - 87105

90016 TRIPLE ARCHED FINIAL DISPLAY

Triple Arched Finial

Garden Fence Post 54pcs - 87599
Triple Finial Section 36pcs - 87500
Triple Finial Gate 3 pcs - 87501

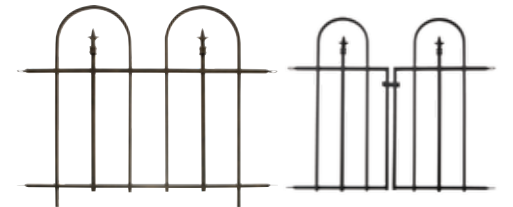

Fence Panel	Fence Gate	Fence Post
87500 / Black 4 per case	87501 / Black 3 per case	87599 / Black 12 per case
Product Dims: 36 in. H x 48 in. W	Product Dims: 34 in. H x 36 in. W	Product Dims: 46 in. H

TRIPLE ARCH

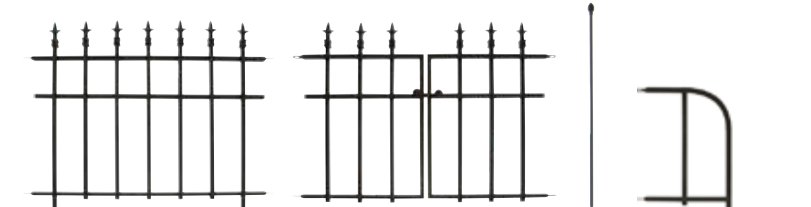

Fence Panel	Fence Gate	Fence Post	End Panel
87103 / Black 10 per case	87104 / Black 3 per case	87102 / Black 12 per case	87105 / Black 6 per case
Product Dims: 30 in. H x 36 in. W	Product Dims: 27 in. H x 36 in. W	Product Dims: 38 in. H	Product Dims: 11.3 in W x 20.5 in. H

CLASSIC FINIAL

Galvanized Steel

Galvanized Inside & Out
Powder Coating

Fence Panels are made with Triple Wall Coated Tubular Steel



Fence Panel	Fence Gate	Fence Post	End Panel
87230 / Bronze 10 per case	87231 / Bronze 3 per case	87299 / Bronze 12 per case	87232 / Bronze 6 per case
Product Dims: 30 in. H x 36 in. W	Product Dims: 27 in. H x 37 in. W	Product Dims: 38 in. H	Product Dims: 11.3 in W x 20.5 in. H

ARCHED FINIAL

Unlimited Configurations!

Combine gates, sections and end panels with posts to create an authentic wrought iron fence that is sturdy and affordable. The possibilities are endless – adding style and protection to a garden has never been so easy.



Gated Entryway

Requires: (2) fence panels / (1) gate (2) end panels / (4) posts.



Front Walkway

Requires: (4) fence panels (2) end panels / (6) posts.



Garden Enclosure

(approx. 15 ft. x 6 ft.)
Requires: (12) fence panels (2) gates / (14) posts.

LARGE Multi-Purpose GRID FENCE



- Fence panels available in 2 sizes: 42" & 30" HIGH
- Easy to assemble, breakdown & store!
- Long lasting pre-galvanized & powder coated finish.

PERFECT FOR PET & GARDEN PROTECTION



INSTALLATION EASY AS 1-2-3

POST CONVERTS FENCE PANEL INTO A GATE

STEP 1
ALIGN RINGS

STEP 2
INSERT POST

STEP 3
DRIVE

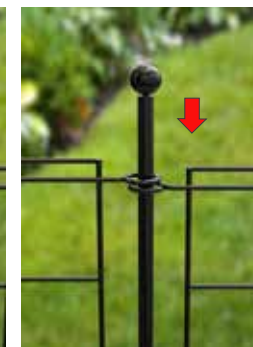

1

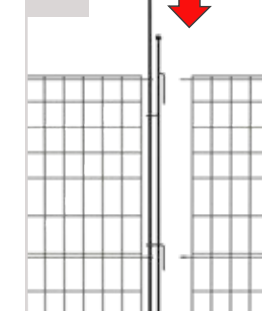

Insert post through fence panel rings and gate latch rings

2

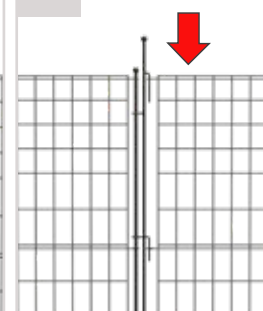

Gate latch hooks onto next panel to lock

3

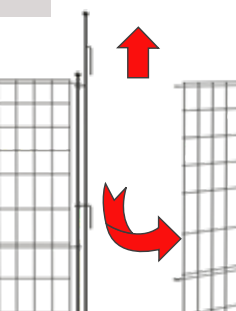

Pull up on gate latch and swing panel to open

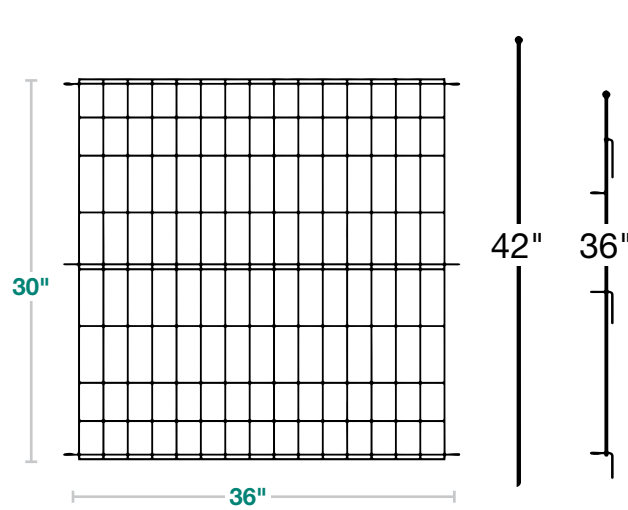

30" H FENCE SYSTEM

- **Small Multi-Purpose Grid Fence Panel**
30 in H x 36 in W - 81801 / 12 per case
- **Small Multi-Purpose Grid Fence Post Stake**
42 in H - 81802 / 12 per case
- **Small Multi-Purpose Grid Fence Latch Post Stake**
36 in H - 81804 / 6 per case

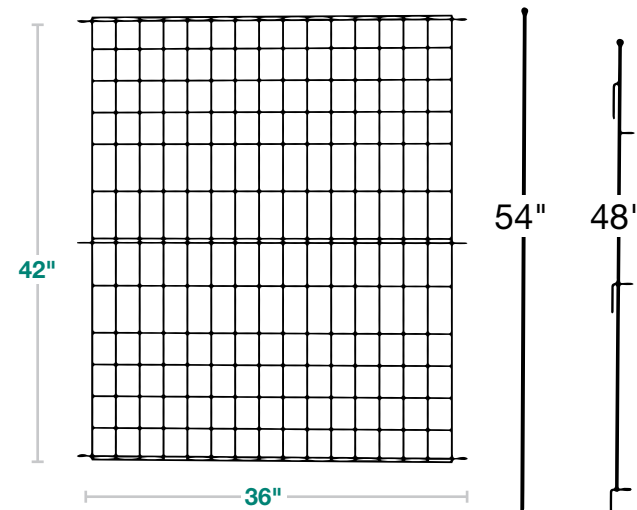

42" H FENCE SYSTEM

- **Large Multi-Purpose Grid Fence Panel**
42 in H x 36 in W - 81800 / 12 per case
- **Large Multi-Purpose Grid Fence Post Stake**
54 in H - 81803 / 12 per case
- **Large Multi-Purpose Grid Fence Latch Post Stake**
48 in H - 81805 / 6 per case

COMPACT, Multi-Purpose GRID FENCE DISPLAY

AVAILABLE AS A FULLY LOADED DISPLAY, OR EMPTY TO BUILD-YOUR-OWN ASSORTMENT

Compact Multi-Purpose Grid 132-PC Fence Display includes:

Compact, Multi-purpose, 132PC Grid Fence Display

Display Number: 90-90425EM (EMPTY, Build-Your-Own Assortment)

Display Number: 90-90425 (LOADED, includes the below products)

Item#	Description	QTY
81800	Large Multi-Purpose Grid Fence Panel	24
81801	Small Multi-Purpose Grid Fence Panel	24
81802	Small Multi-Purpose Grid Fence Post Stake	36
81803	Large Multi-Purpose Grid Fence Post Stake	36
81804	Small Multi-Purpose Grid Fence Latch Post Stake	6
81805	Large Multi-Purpose Grid Fence Latch Post Stake	6

Total number of product pieces on display 132



Large Grid Garden Fence

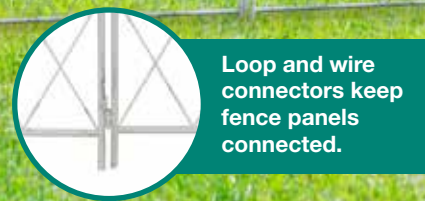
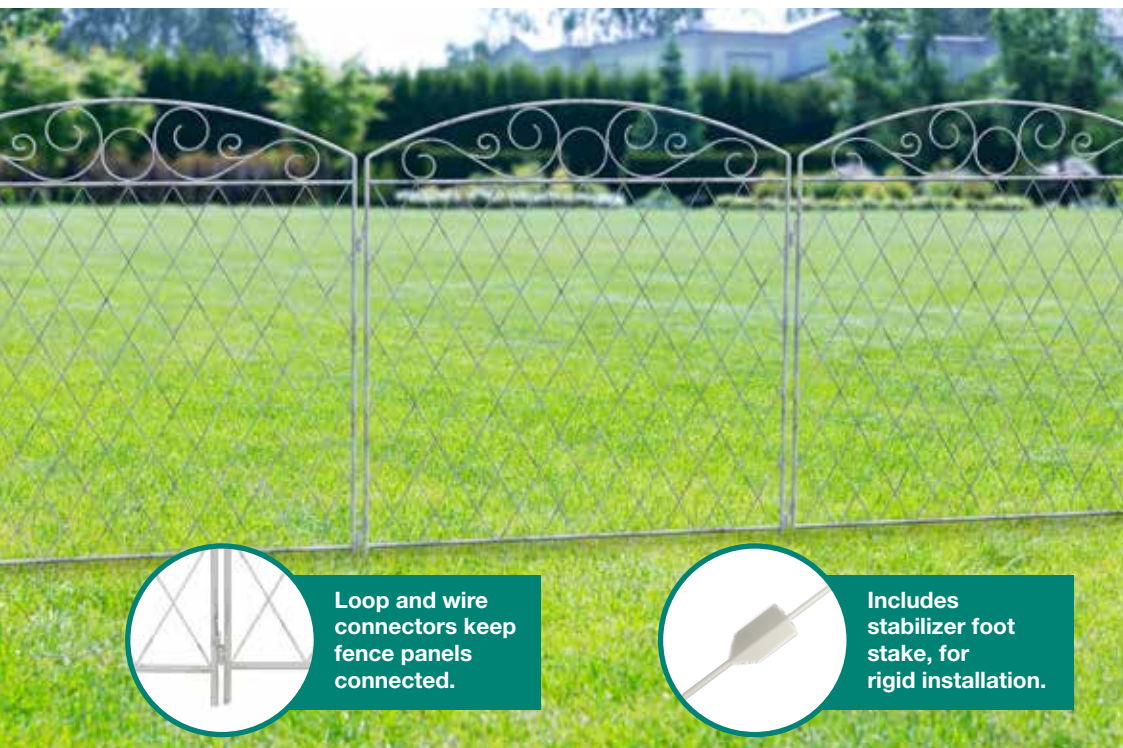

Loop and wire connectors keep fence panels connected.



Includes stabilizer foot stake, for rigid installation.

French Country XL Grid Fence

Includes stabilizer foot stake, for rigid installation.

87560 / Distressed White
10 per case

Product Dims:
38 in. H x 36 in. W



36-PC French Country XL Grid Fence Display

90-90274 / 36 Pieces

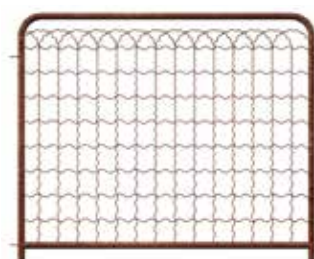

Rustic Heirloom Cottage Garden Fence Panel

83681 / Rust Finish
12 per case

Product Dims:
16 in. H x 18 in. W

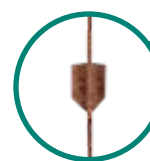

Includes stabilizer foot stake, for rigid installation.

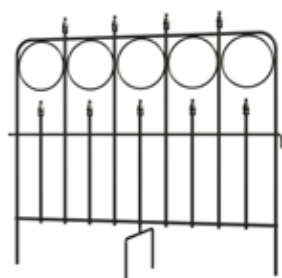

Self-contained stabilizer foot, integrated into the center post.

Arts & Crafts Sectional Fence

87540 / Black
10 per case

Product Dims:
32 in. H x 36 in. W

Small Border Edge

Each fence panel on this page is 14 inches high and is packed in a decorative display carton.

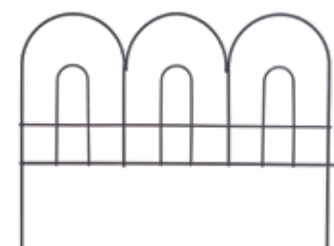

Arched Border Edge

24 per case.

89394 / Black

Product Dims:
14 in. H x 18 in. W



Arched Border Edge

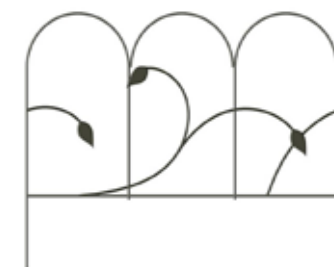

Leaf Border Edge

89399 / Black / 24 per case

Product Dims:
14 in. H x 18 in. W

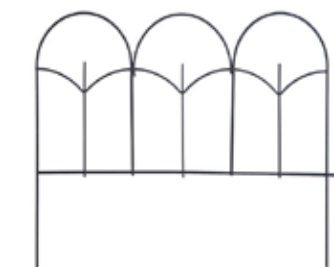

Triple Stalk Border Edge

89393 / Black / 24 per case

Product Dims:
14 in. H x 18 in. W



Triple Stalk Border Edge

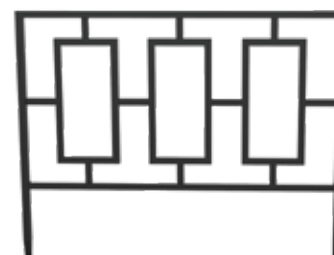

Contemporary Border Edge

84575 / Black / 12 per case

Product Dims:
14 in. H x 18 in. W

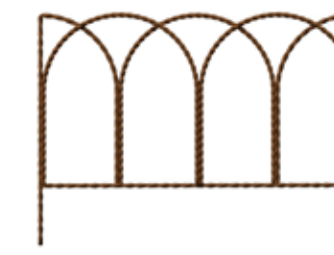

Rustic Farmhouse Twisted Wire Border Edge

89362 / Rust / 12 per case

Product Dims:
14 in. H x 20 in. W



Rustic Farmhouse Twisted Wire Border Edge

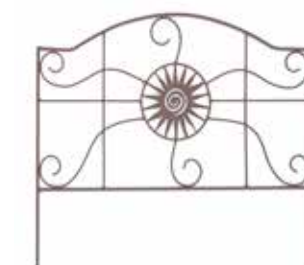

Aztec Sun Border Edge

84573 / Rust Finish / 12 per case

Product Dims:
14 in. H x 18 in. W

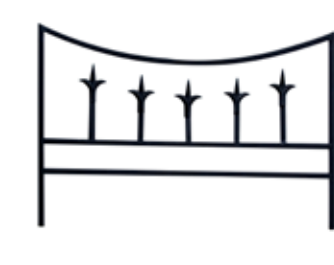

Classic Finial Border Edge

89386 / Black / 12 per case

Product Dims:
14 in. H x 18.5 in. W



Classic Finial Border Edge



MODERN FARMHOUSE
HOME & GARDEN™

More Decorative

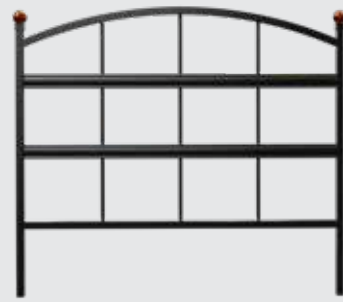

MODERN FARMHOUSE
HOME & GARDEN™

Modern Farmhouse
Garden Edge

81433 / Black / 12 per case

Product Dims:
16 in. H x 18 in. W

Border Edge



THE PERCHING BIRDS COLLECTION

Perching Birds
Border Edge

84565 / Black / 12 per case

Product Dims:
18 in. H x 24 in. W



THE PERCHING BIRDS COLLECTION



MISSION
COLLECTION

MISSION
COLLECTION

Mission Collection
Border Edge

82174 / Black / 12 per case

Product Dims:
18 in. H x 20 in. W



RUSTICA
ITALIA



Beautiful
Oil Rubbed
Bronze Finish

Rustica Italia
Border Fence

83661 / Black / 12 per case

Product Dims:
18 in. H x 24 in. W



RUSTICA
ITALIA



French Country SCROLL COLLECTION



French Country Scroll
Border Edge

83620 / Distressed White
12 per case

Product Dims:
16 in. H x 18 in. W



Finial
Garden Edge

89382 / Black
12 per case

Product Dims:
16 in. H x 18 in. W

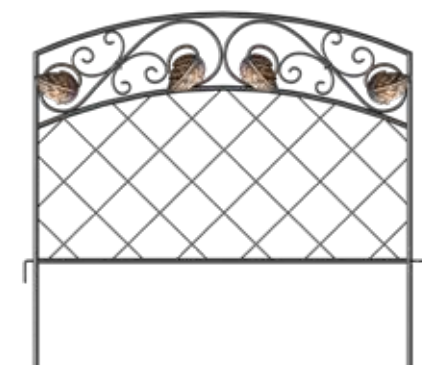

Scroll & Ivy Lattice
Garden Edge

89395 / Black & Bronze
12 per case

Product Dims:
16 in. H x 18 in. W

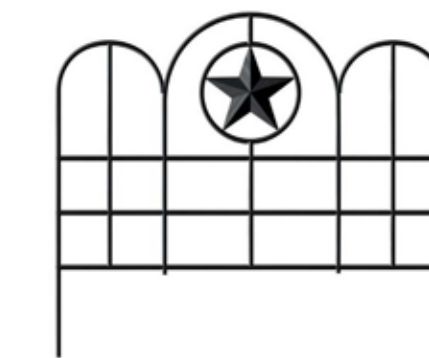

Star
Border Edge

89392 / Black
12 per case

Product Dims:
16 in. H x 18 in. W





Taller Border Edge

22"

Forged Garden with Leaves Border Edge

89483 / Black / 10 per case

Product Dims: 19 in. H x 22 in. W

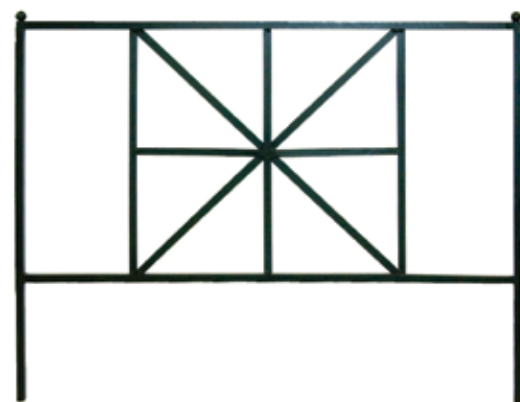

24"

British Cross Garden Edge

89377 / Black / 12 per case

Product Dims: 20 in. H x 24 in. W



18"

Scroll Border Edge

89530 / Black / 12 per case

Product Dims: 18 in. H x 18 in. W

Classic Border Edge

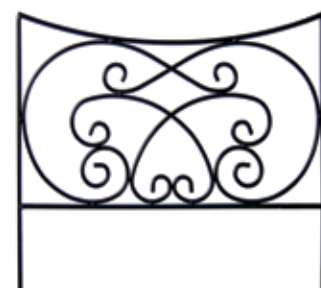

18"

Crossing Scroll Border Edge

89387 / Black / 12 per case

Product Dims: 16 in. H x 18 in. W

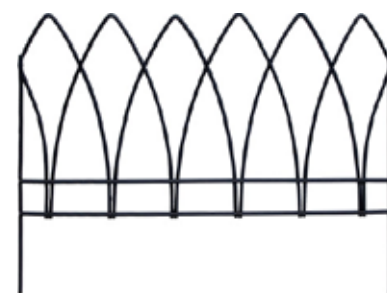

24"

Gothic Arch Border Edge

89523 / Black / 12 per case

Product Dims: 15 in. H x 24 in. W

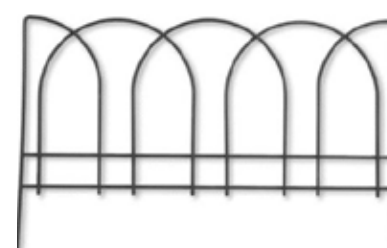

24"

Arches Border Edge

89050 / Black / 12 per case

Product Dims: 15 in. H x 24 in. W

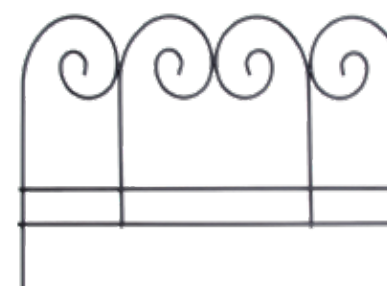

24"

Scroll Border Edge

89048 / Black / 12 per case

Product Dims: 16 in. H x 24 in. W



Gothic Arch Border Edge



Arches Border Edge



Resin Wicker

Looks Like Natural Woven Wicker But Lasts Years!

24"



Resin Wicker Border Edge

82330 / Natural / 12 per case

Product Dims: 14 in. H x 24 in. W



Made-in-USA Wood Border Edge

American Ponderosa Pine Edging Makes Economical Garden Edge

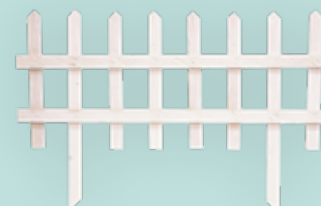

Wood Picket Fence Border Edge

88002 / White / 24 per case

Product Dims: 23 in. H x 36 in. W



Cape Cod Picket Fence Border Edge

88022 / Brown / 20 per case

Product Dims: 12 in. H x 16 in. W



Wood Picket Fence Border Edge

88001 / Brown / 24 per case

Product Dims: 23 in. H x 36 in. W
Fence - Small Border Edge | 97

Folding & Roll Fencing In Lengths Up To 8 Foot Long!

Available in 2 Colors

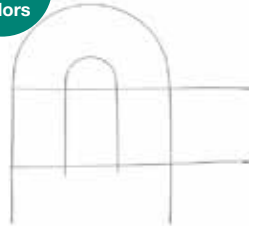

Arch Folding Fence

All 24 per case.

89312 / Green

89313 / White

Product Dims:
18 in. H x 8 ft. W

Available in 2 Colors

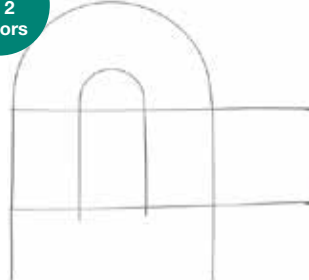

Arch Folding Fence

All 10 per case.

89316 / Green

89317 / White

Product Dims:
24 in. H x 8 ft. W

Available in 2 Colors



Arch Folding Fence

All 10 per case.

89301 / Green

89300 / White

Product Dims:
32 in. H x 8 ft. W

Available in 2 Colors



Arch Folding Fence

All 15 per case.

89318 / Green

89319 / White

Product Dims:
10 in. H x 10 ft. W

Available in 2 Colors



Gothic Folding Fence

All 20 per case.

89314 / Green

89315 / White

Product Dims:
18 in. H x 8 ft. W

A

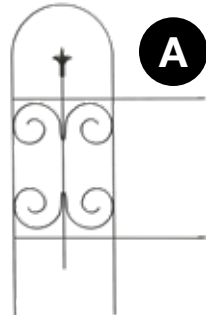

B

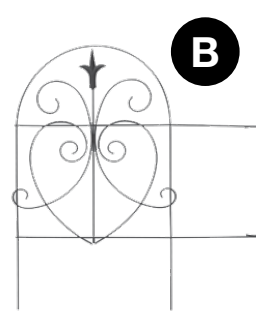

C



Finial Folding Fence

89373 / Black
10 per case

Product Dims:
32 in. H x 8 ft. W

Romantic Finial Folding Fence

89379 / Black
10 per case

Product Dims:
18 in. H x 8 ft. W

Leaf Folding Fence

89363 / Brown
10 per case

Product Dims:
32 in. H x 8 ft. W

Folding Fence with Frog

89374 / Green
10 per case

Product Dims:
32 in. H x 8 ft. W

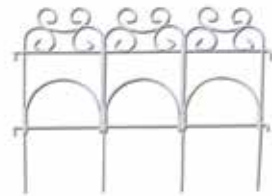

Decorative Folding Fence

89306 / White
10 per case

Product Dims:
14 in. H x 7.5 ft. W



Lattice Folding Fence

89360 / Black
10 per case

Product Dims:
18 in. H x 8 ft. W



Roll Fencing

Fence Roll Flat Top

All 6 per case.

89302 / Green

89303 / White

Product Dims:
14 in. H x 25 ft. W

Fence Roll Arched Top

All 6 per case.

89307 / White

89309 / Green

Product Dims:
14 in. H x 20 ft. W



Finial Folding Fence



Romantic Finial Folding Fence



Leaf Folding Fence



Decorative Folding Fence

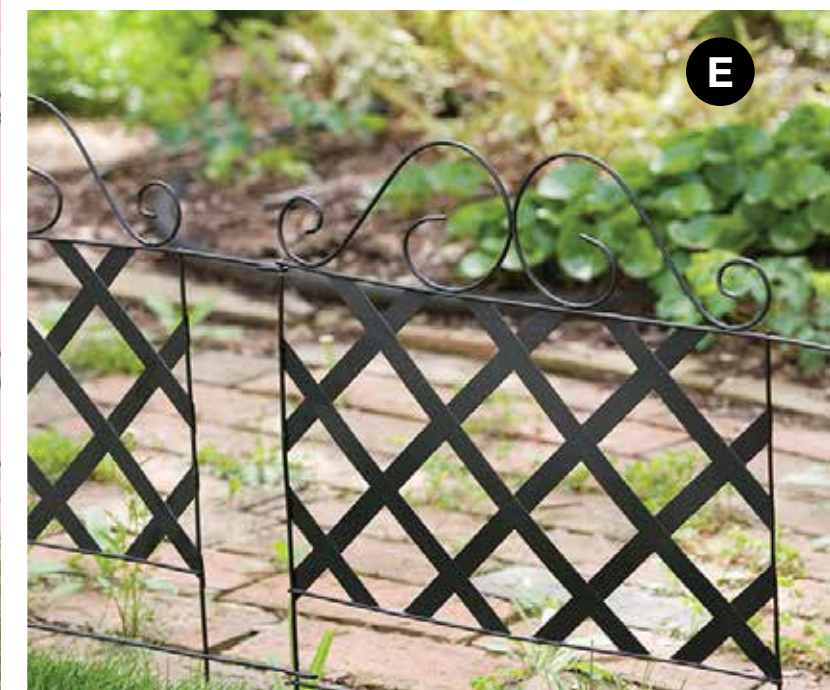

Lattice Folding Fence

Decorative Metal Landscape Edging

Combining the Elegant Look of Cast Iron Edging with Professional-Grade Metal Landscape Edging.

We've taken metal landscape edging to a new level with stamped ornamentation that gives this functional product line more personality. Classic designs popular in our wire border fence, like finial and arch shapes, are combined with professional-grade 1.5mm thick sheet metal that can be easily installed to fit any landscape. Pre-galvanized sheet metal is powder coated with rugged, textured finishes for an elegant appearance.

Easily Bends to Any Shape



FASHION AND FUNCTION!

LANDSCAPE EDGING SPECIAL BUY!



Metal Flat Top Landscape Edging 3-PC Kit

82455 / Green
6 per case

INCLUDES:

- 4 ground stakes
- 3 dual design landscape edging sections (Nearly 7 feet of fencing per selling unit and 4" high, each piece being 36 in. W)
- Colorful and informational packaging

AVAILABLE IN 3 DESIGNS

STAKES SOLD SEPARATELY

A Finial Landscape Edging

83644 / Black / 12 per case

Product Dims: 8 in. H x 36 in. W

B Straight Edge Landscape Edging

83640 / Black / 12 per case

Product Dims: 5 in. H x 36 in. W

C Scalloped Landscape Edging

83641 / Bronze / 12 per case

Product Dims: 5 in. H x 36 in. W

COMPLETE OR ENHANCE YOUR STOCK WITH OUR...

Universal Landscape Edging Stakes



Each metal edge strip is installed using our 10.5"H Metal Landscape Edging Stakes (sold separately). 3 per pack, in a matching finish. The stakes connect two strips securely together end-to-end with no wasted overlap. They also install in the center of each strip to provide more flexibility when bending them into curved shapes. An angled, flat top on each stake makes it easy to hammer them into the ground without damaging edging and provides more stability.



10.5" Metal Landscape Edging Stakes
Universal stakes. All 12 per case. 3 per pack.

83650 / Black

83651 / Bronze

GREAT Merchandising Options!

Shipped In Attractive Display Carton

Each metal landscape edge is packaged and sold individually in a 12-piece colorful pdq carton for impact & easy shopping.



FREE DISPLAY!
with 6 or more cases
\$50 Value

Free Standing Landscape Edging Display

Free Standing Landscape Edging Display

90-90262EM / EMPTY



A

Finial Landscape Edging

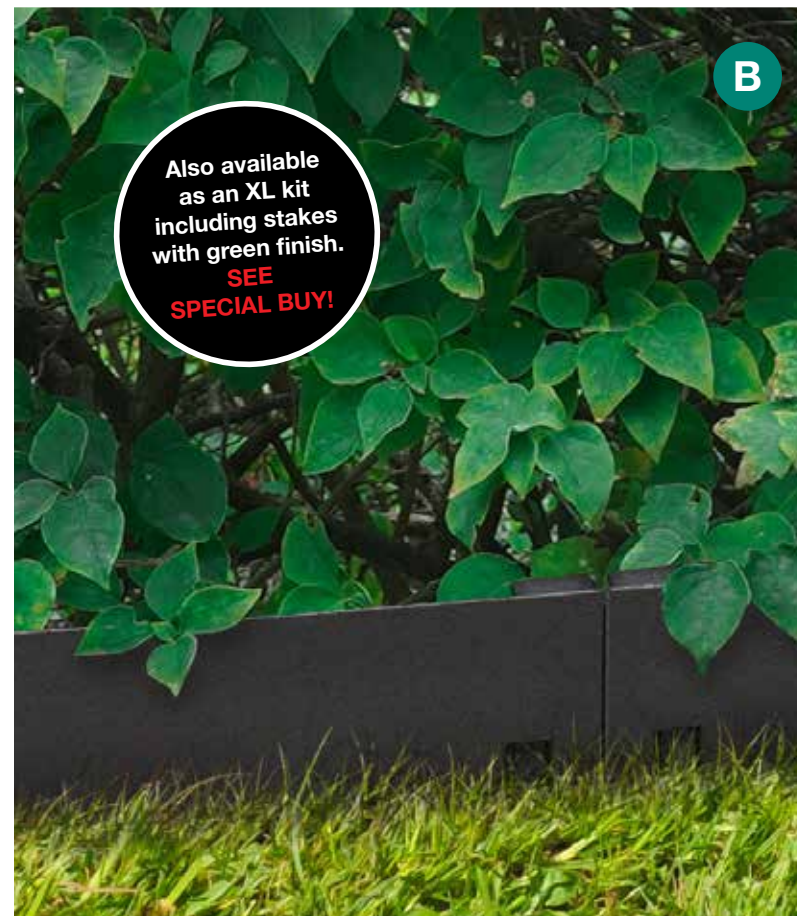

B

Also available as an XL kit including stakes with green finish.
SEE SPECIAL BUY!

Straight Edge Landscape Edging

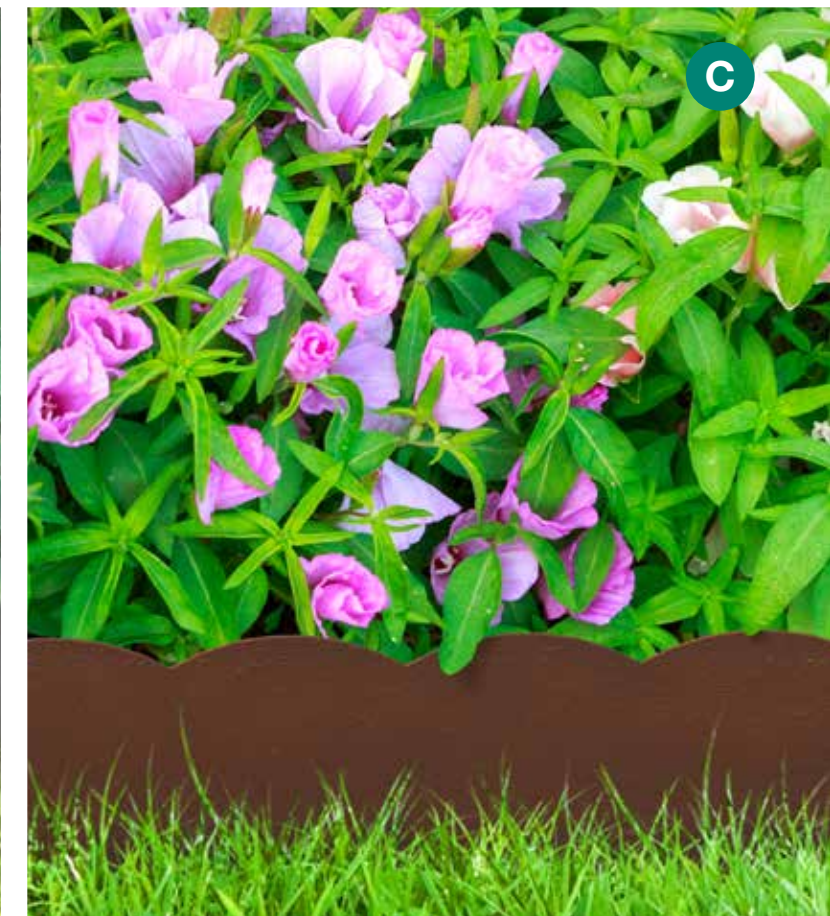

C

Scalloped Landscape Edging

Classic Metal Trellis

- A** *French Arch Trellis with Finials*
89643 / Black / 5 per case
Product Dims:
24 in. W x 80 in. H
- B** *Arch Trellis with Finials*
89634 / Black / 5 per case
Product Dims:
18 in. W x 72 in. H
- C** *Narrow Trellis with Finials*
89641 / Black / 10 per case
Product Dims:
8 in. W x 60 in. H

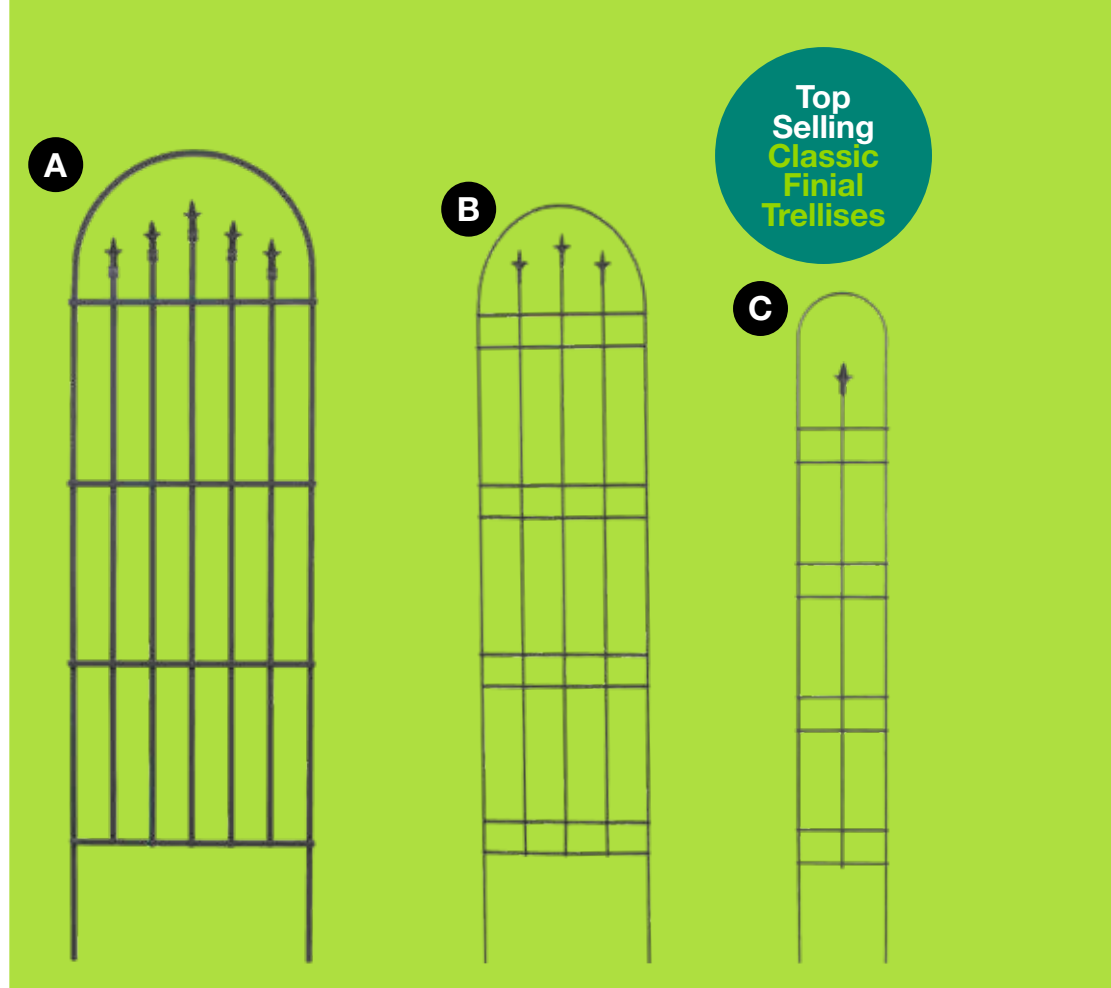

French Arch Trellis with Finials



Classic Trellis

NARROW 60" TRELLISES MAKE IDEAL POT TRELLISES



See More Pot Trellises On Next Pages

- 60"**
Narrow Scroll Trellis
89216 / Green
10 per case
Product Dims:
7 in. W x 60 in. H
- 60"**
Narrow Arch Trellis
89218 / Green
10 per case
Product Dims:
7 in. W x 60 in. H
- 60"**
Wave Trellis
89637 / Green
12 per case
Product Dims:
20 in. W x 60 in. H
- 48"**
Wave Pot Trellis
89636
Garden Shed Green
10 per case
Product Dims:
48 in. H

72"
Window Pane Trellis
83764 / Matte White
5 per case
Product Dims:
30 in. W x 72 in. H

72"
Window Pane Trellis
83763-5 / Matte Black
5 per case
Product Dims:
30 in. W x 72 in. H

84"
Neo Classic Trellis
89200 / Green
5 per case
Product Dims:
24 in. W x 84 in. H

72"
Classic Trellis
88733 / Black
4 per case
Product Dims:
22 in. W x 72 in. H

Dimensional / Curved Metal Trellises



Offset Finial Garden Trellis

89675 / Black
5 per case

Product Dims:
24 in. W x 72 in. H

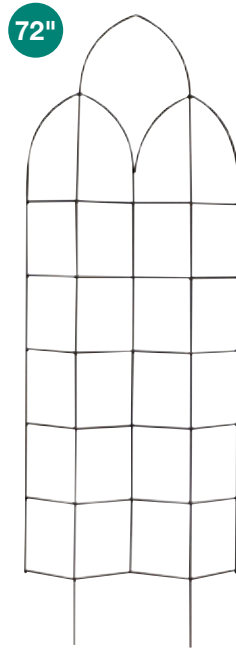

Offset Spires Garden Trellis

89658 / Black
5 per case

Product Dims:
24 in. W x 72 in. H



Offset Spires Garden Trellis

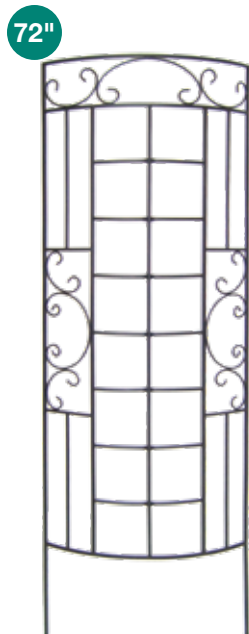

Romantic Curved Garden Trellis

89677 / Black
5 per case

Product Dims:
24 in. W x 72 in. H

See also our **Half-Round Trellis Plant Supports**

on pages 128-129

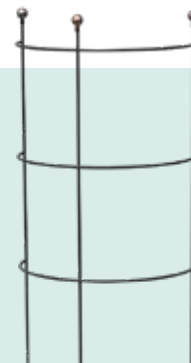

Curved Trellis Assortment

Display Number: **90-90133**

Item#	Description	UPC	QTY
89677	72" Romantic Curved Trellis	093432896778	5
89656	82" x 20" Semi-Round Trellis	093432896563	5
89657	72" x 10" Semi-Round Trellis	093432896570	5
89658	72" Offset Spires Trellis	093432896587	5
90-89400	4 Trellis Display Unit		1
Total number of product pieces on display			20

Arts & Crafts Semi-Round Trellises

Great for Concealing Downspouts or Placed Around Trees

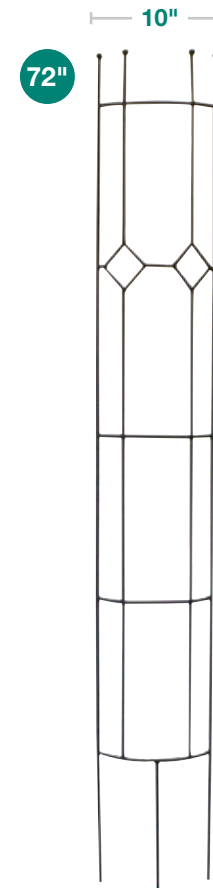

Great for Downspouts

72" Semi-Round Arts & Crafts Narrow Trellis

89657 / 10" W
Black / 5 per case

Product Dims:
72 in. H x 10 in. W

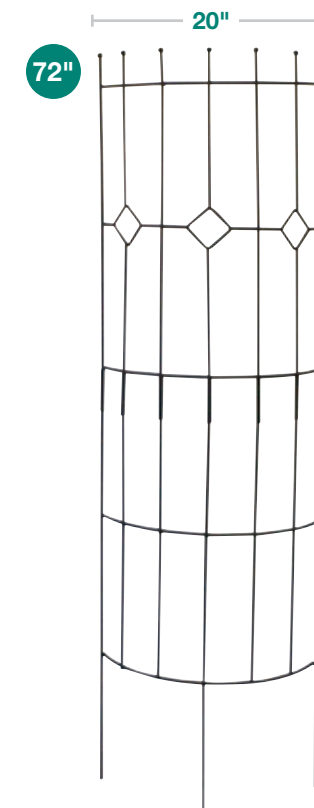

Great Around Large Trees

72" Semi-Round 2-Piece Arts & Crafts Wide Trellis

89656 / 20" W
Black / 5 per case

Product Dims:
72 in. H x 20 in. W



RUSTICA
ITALIA



Rustic Italia
Trellis Gate with Free-Standing Foot

Decorative Collection Metal Trellises

84"



Rustic Italia
Trellis Gate with
Free-Standing Foot

84450 / Bronze / 5 per case

Product Dims: 24 in. W x 84 in. H

60"



Rustic Italia
Pot Trellis With
Free-Standing Base

84451 / Bronze / 4 per case

Product Dims: 13 in. W x 60 in. H

MISSION
COLLECTION



Mission Collection
Garden Trellis

MODERN FARMHOUSE
HOME & GARDEN™



Modern Farmhouse
Garden Trellis



Scroll
Trellis

72"

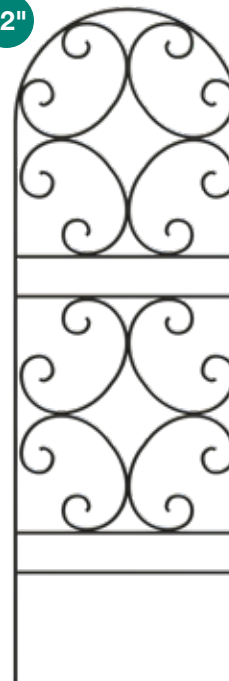

Scroll
Trellis

84401 / Black / 5 per case

Product Dims: 24 in. W x 72 in. H

Unique tubular
construction provides
a bulky, rugged look.

36"



Scroll
Pot Trellis

84490 / Black / 5 per case

Product Dims: 12.25 in. W x 36 in. H

78"

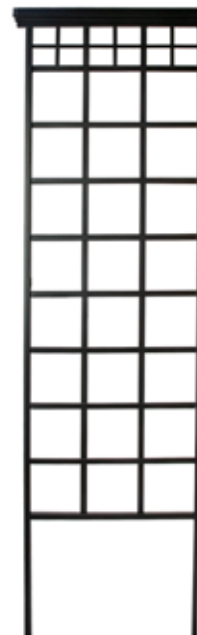

Mission Collection
Garden Trellis

82172 / Black / 5 per case

Product Dims:
23 in. W x 78 in. H

58"



Mission Collection
Pot Trellis

With free-standing base.

82173 / Black / 4 per case

Product Dims:
15.625"W x 58"H

75"



Modern Farmhouse
Garden Trellis

81431 / Black / 5 per case

Product Dims:
25 in. W x 75 in. H

60"



Modern Farmhouse
Pot Trellis

81432 / Black / 5 per case

Product Dims:
11 in. W x 60 in. H

SEE MORE MATCHING COLLECTION ACCESSORIES THROUGHOUT THIS CATALOG

Decorative Collection Metal Trellises



Contemporary
Classical Trellis

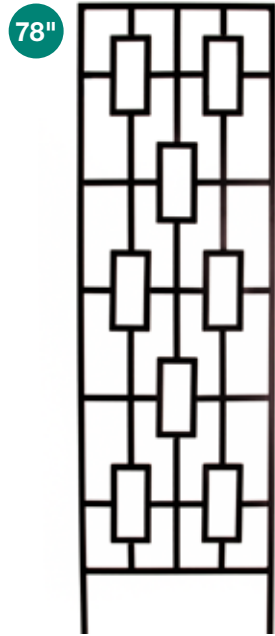

Contemporary
Classical Trellis

84447 / Black
5 per case

Product Dims:
23 in. W x 78 in. H



Contemporary
Pot Trellis

84445 / Black
5 per case

Product Dims:
8 in. W x 46 in. H

THE PERCHING BIRDS COLLECTION

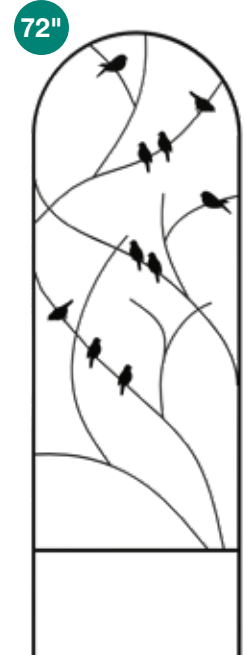

Perching Birds
Garden Trellis

84495 / Black
5 per case

Product Dims:
24 in. W x 72 in. H



Perching Birds
Pot Trellis

84493 / Black
5 per case

Product Dims:
10 in. W x 40 in. H



Perching Birds
Pot Trellis

SEE MORE MATCHING COLLECTION ACCESSORIES THROUGHOUT THIS CATALOG



Rustic Farmhouse
Quilt Pot Trellis

Rustic Farmhouse
Quilt Pot Trellis
83783 / Rust Finish
5 per case
Product Dims:
10 in. W x 50 in. H



Rustic Farmhouse
Quilt Trellis

83780 / Rust Finish
2 per case

Product Dims:
24 in. W x 72 in. H



Rustic Farmhouse
Twisted Wire
Pot Trellis

83793 / Rust Finish
5 per case

Product Dims:
12 in. W x 46 in. H

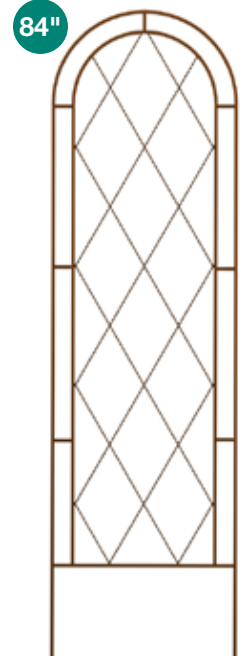

Twisted Wire
Trellis

84527 / Rust Finish
5 per case

Product Dims:
24 in. W x 84 in. H



French Country
Scroll Trellis



French Country
Scroll Trellis

83790 / Distressed White
5 per case

Product Dims:
23 in. W x 60 in. H



French Country
Pot Trellis

86231 / Distressed White
6 per case

Product Dims:
10 in. W x 36 in. H



MADE-IN-THE UK COLLECTION



Tom Chambers has been a British manufacturer of garden products for 50 years. Located in Yorkshire, England, this product line includes handcrafted, classic metalwork with European styling that is simple, but very rugged. We're pleased to bring this premium British garden collection to the U.S. market to offer your customers an alternative finish and styling that is unique and upscale.



Large Lattice Trellis

82003 / Black / 5 per case

Product Dims:
23.6 in. W x 70.8 in. H

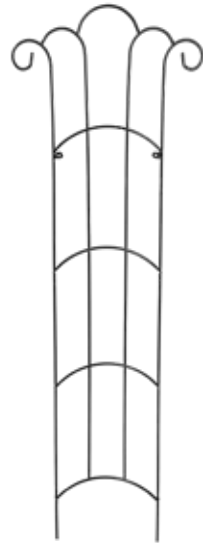

Large Deco Trellis

82002 / Black / 5 per case

Product Dims:
23.6 in. W x 70.8 in. H

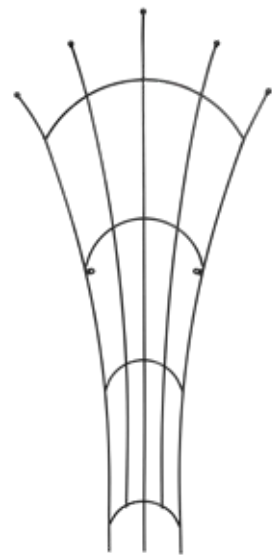

Large Cassia Trellis

82000 / Black / 5 per case

Product Dims:
31.5 in. W x 70.8 in. H

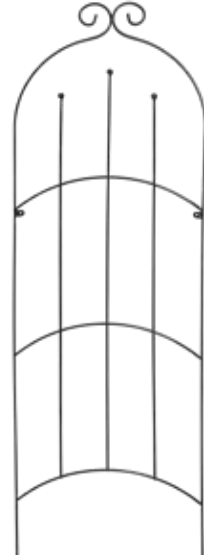

Large Mimosa Trellis

82001 / Black / 5 per case

Product Dims:
23.6 in. W x 70.8 in. H

Dual Attachment Industrial Steel Tube Ladder Trellis

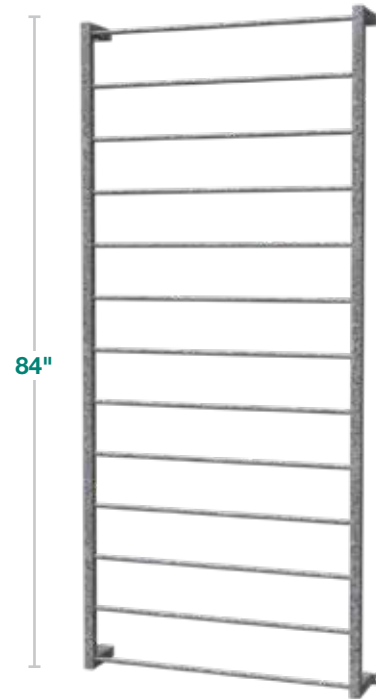

84" H Industrial Steel Tube Ladder Trellis

With wall mounting hardware. Antique iron, powder coated finish.

82157
1 per case

Product Dims:
30 in. W x 84 in. H

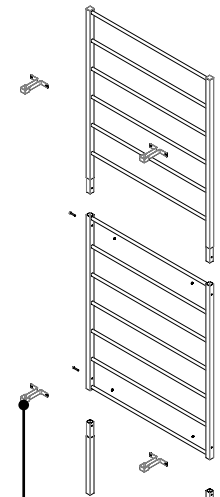

Includes optional hardware for floating wall mount or in-ground installation



Compact 30.25" W x 37.25" H color box is ideal for eCommerce



Industrial Steel Tube Ladder Trellis



Unique PE Coating

Provides a soft climbing surface for plants while giving each piece a more rugged, thicker appearance

MATCHING SHEPHERD HOOKS



Single Spiral Shepherd Hook

82030 / 78.7" H
Black / 3 per case



Double Spiral Shepherd Hook

82031 / 78.7" H
Black / 2 per case



Twigs & Leaves Forged Trellises



Forged Twig Trellis with Leaves

89481 / Black
5 per case

Product Dims:
23 in. W x 72 in. H



Narrow Forged Twig Trellis with Leaves

89484 / Black
10 per case

Product Dims:
10 in. W x 72 in. H

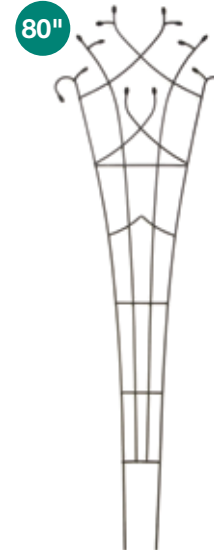

Forged Fan Trellis with Leaves

89482 / Black
5 per case

Product Dims:
26 in. W x 80 in. H



Forged Fan Trellis with Leaves

Decorative Metal Trellises

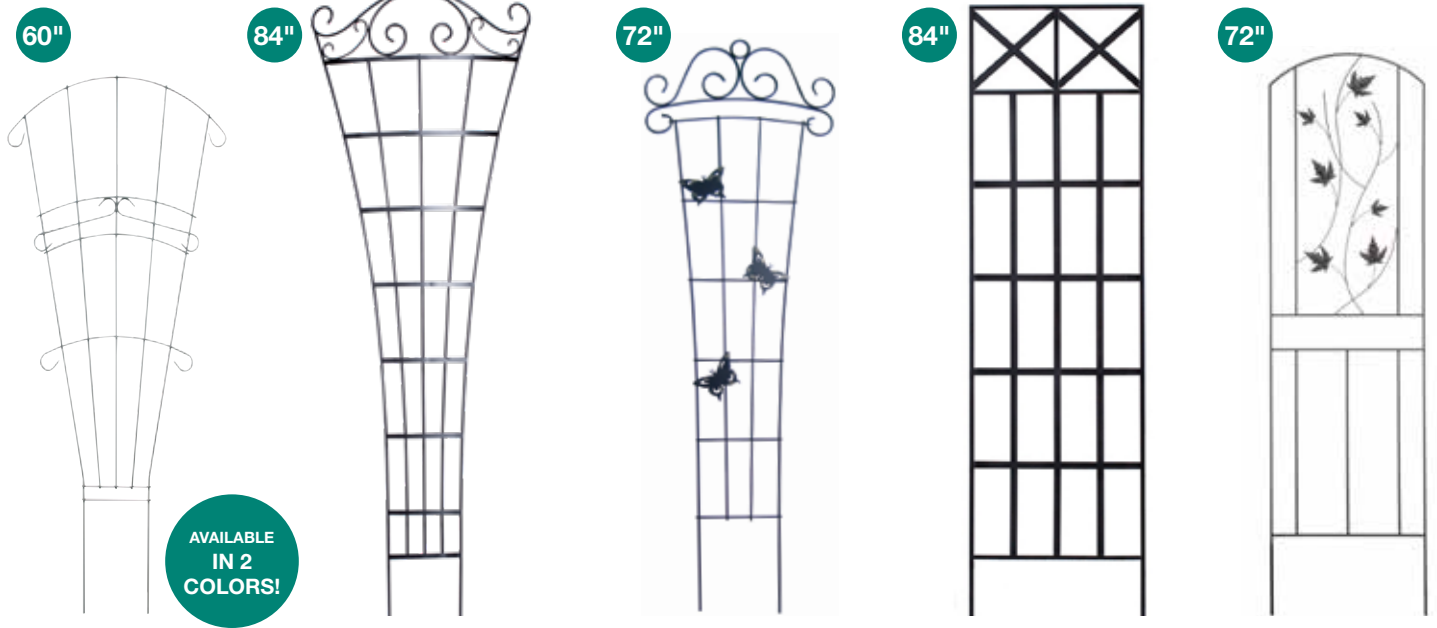

Fan Trellis
All 10 per case.
89075 / Green
89077 / White
Product Dims: 28 in. W x 60 in. H

Romantic Fan Curved Trellis
89676 / Black
5 per case
Product Dims: 27 in. W x 84 in. H

Romantic Butterfly Garden Trellis
89625 / Cameo Brown
5 per case
Product Dims: 24 in. W x 72 in. H

Rivet Trellis
89678 / Black
5 per case
Product Dims: 24 in. W x 84 in. H

Arched Leaf Garden Trellis
89679 / Black
5 per case
Product Dims: 20 in. W x 72 in. H

Small Pot Metal Trellises



Aztec Sun Pot Trellis
84440 / Rust Finish
10 per case
Product Dims: 36 in. H x 12 in. W

Rustic Farmhouse Woven Pot Trellis
83792 / Rust Finish
5 per case
Product Dims: 48 in. H x 11 in. W

Fan Pot Trellis
89635 / Green
12 per case
Product Dims: 15 in. W x 36 in. H



Pot Trellis
88913 / Green
12 per case
Product Dims: 12 in. W x 48 in. H

Save Our Bees, Please!
Matching Bee-Consious Pot & Garden Trellises

Bee-Consious Pot Trellis
81451 / Black
5 per case
Product Dims: 36 in. H x 10 in. W

Bee-Consious Garden Trellis
81450 / Black /
5 per case
Product Dims: 24 in. W x 66 in. H

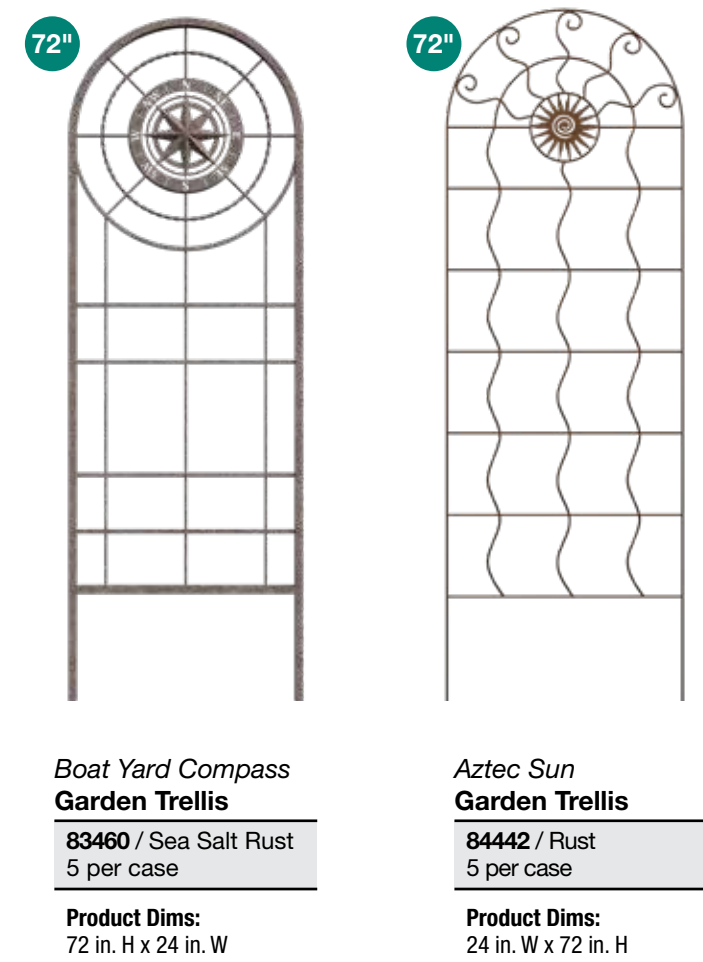

Boat Yard Compass Garden Trellis
83460 / Sea Salt Rust
5 per case
Product Dims: 72 in. H x 24 in. W

Aztec Sun Garden Trellis
84442 / Rust
5 per case
Product Dims: 24 in. W x 72 in. H

Mini Pot Topper

Scroll & Ivy Mini Trellis Pot Topper
83770 / Black & Bronze
8 per case
Product Dims: 24 in. H x 10.25 in. W

This promotional Scroll & Ivy Pot Topper is packed in a convenient display carton.



Scroll & Ivy Mini Trellis Pot Topper

Specialty Metal Trellises



GIANT 108" H TRELLIS

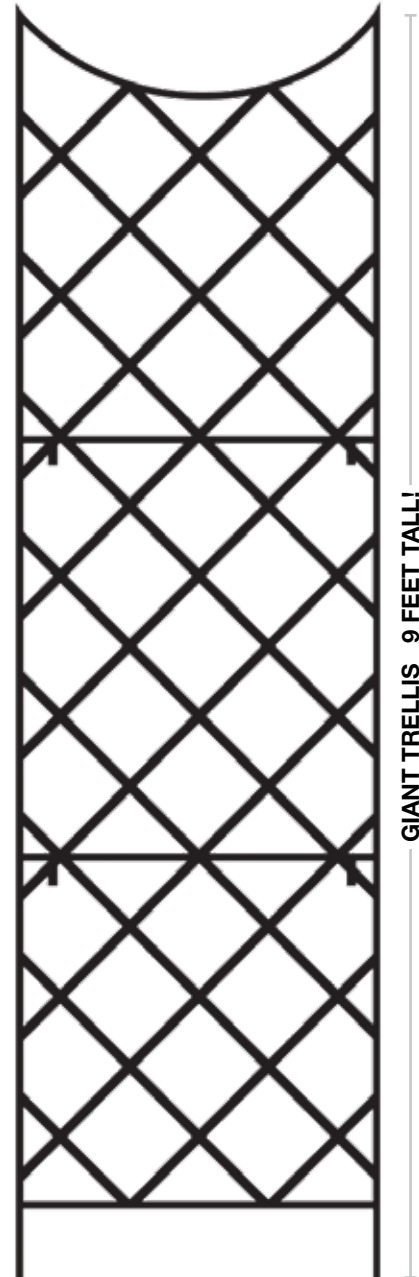

GIANT TRELLIS 9 FEET TALL!

Giant 3-Piece Boxed Trellis

Great for extremely tall vining plants (clematis, morning glory, honeysuckle, & wisteria).



Compact color box is ideal for eCommerce!

108" H Giant Garden Trellis

Includes wall mounting brackets.

89655 / Black / 1 per case

Product Dims: 30 in. W x 108 in. H



Gothic 3-Panel Garden Screen Trellis

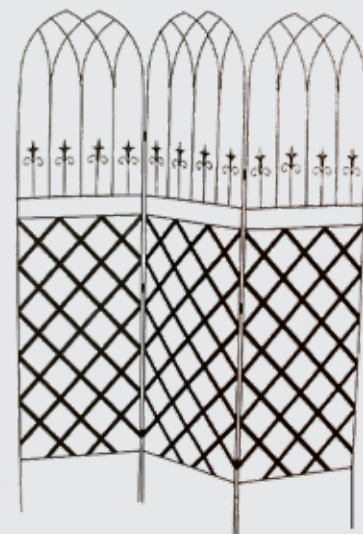

Gothic 3-Panel Garden Screen Trellis

89660 / Black / 2 per case

Product Dims: 60 in. W x 72 in. H

See also our Folding Towers & Trellis Plant Supports on pages 126-127

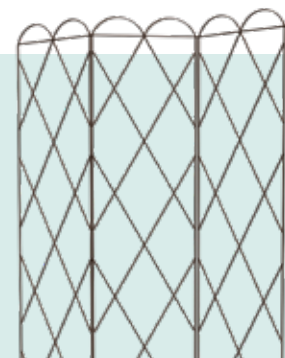

MODERN FARMHOUSE HOME & GARDEN



Combines Privacy, Vertical Gardening, And A Trellis For Vining Plants

Free-Standing 3-Panel Trellis & Privacy Screen With Plant Pot Holder Rings

Modern Farmhouse Free Standing 3-Panel Trellis & Privacy Screen With plant holder rings.

82155 / Black / 1 per case

Product Dims: 37 in. W x 72 in. H x 7 in. D

This boxed item includes a full color label (not kd - box height 72 inches).



Includes 6 pot holder rings - each fits a 6" pot.

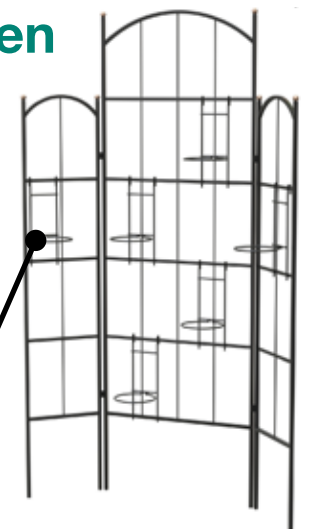

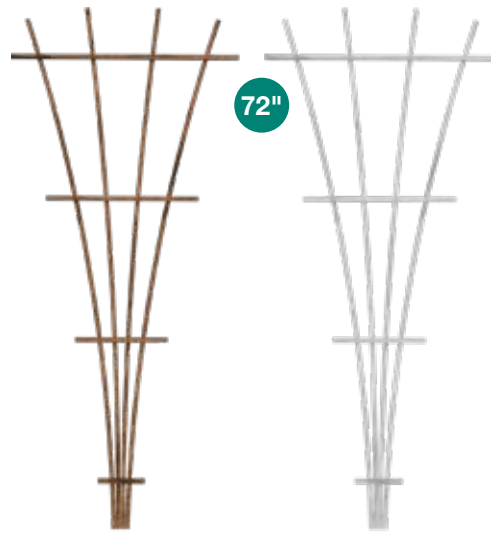

72" Wood Fan
Garden Trellis

82425 / Brown / 6 per case

83735 / White / 6 per case

Product Dims:
32 in. W x 72 in. H



48" Wood Fan
Garden Trellis

83737 / Brown / 6 per case

83747 / White / 6 per case

Product Dims:
24 in. W x 48 in. H

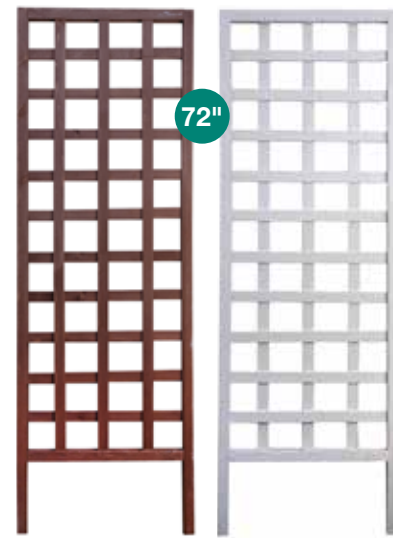

72" Wood Square
Framed Trellis

81914 / Brown / 6 per case

81913 / White / 6 per case

Product Dims:
72 in. H x 24 in. W



Wood Contemporary
Small Pot Trellis



Wood Framed Flower & Garden
Wire Grid Trellis

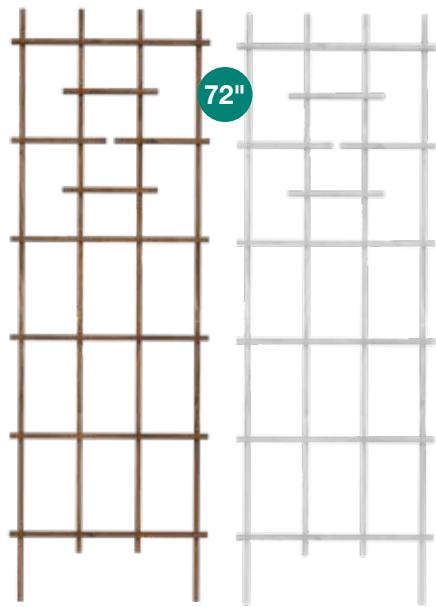

72" Wood Ladder
Garden Trellis

82426 / Brown / 6 per case

83736 / White / 6 per case

Product Dims:
24 in. W x 72 in. H

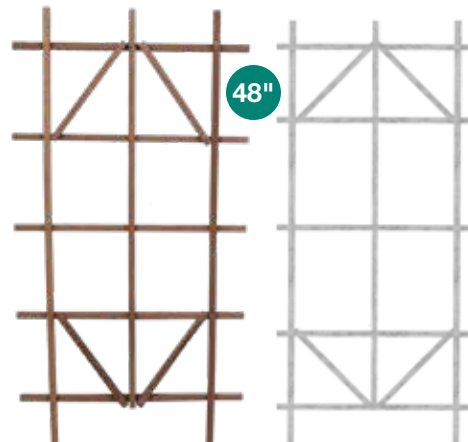

48" Wood Ladder
Garden Trellis

83738 / Brown / 6 per case

83746 / White / 6 per case

Product Dims:
24 in. W x 48 in. H



72" Wood Diamond
Framed Trellis

81909-6 / Brown / 6 per case

81915 / White / 6 per case

Product Dims:
72 in. H x 24 in. W

NEW! Wood Trellis Styles with Contemporary and Functional Options



Contemporary Wood Garden Trellises
With On-Trend Charcoal Finish

Wood
Contemporary
Large Trellis

81922 / Charcoal
6 per case

Product Dims:
24 in. W x 72 in. H



Wood
Contemporary
Small Pot Trellis

81923 / Charcoal
6 per case

Product Dims:
10 in. W x 47 in. H



Functional Cedar Trellises Are Great
For A Variety Of Vegetable Gardens

72" H
Expandable
Pyramid Trellis

81964 / Cedar
6 per case

Product Dims:
72 in. H



48" H
Heavy Duty
Folding Trellis

81963 / Cedar
6 per case

Product Dims:
24 in. W x 48 in. H



72" H
Wood Framed
Flower & Garden
Wire Grid Trellis

82158
Natural Cedar & Black Wire
4 per case

Product Dims:
72 in. H x 24 in. W

Obelisks In A Variety Of Attractive Styles & Sizes!

<p>IN 3 SIZES!</p> <p>36" 48" 60"</p> <p>Garden Obelisks Cameo brown finish.</p> <table border="1"> <tr><td>89328 / 36 in. H / 6 per case</td></tr> <tr><td>89327 / 48 in. H / 1 per case</td></tr> <tr><td>89326 / 60 in. H / 1 per case</td></tr> </table>	89328 / 36 in. H / 6 per case	89327 / 48 in. H / 1 per case	89326 / 60 in. H / 1 per case	<p>IN 2 SIZES!</p> <p>36" 60"</p> <p>Circular Finial Obelisks Black finish.</p> <table border="1"> <tr><td>89357 / 36 in. H / 5 per case</td></tr> <tr><td>89356 / 60 in. H / 4 per case</td></tr> </table>	89357 / 36 in. H / 5 per case	89356 / 60 in. H / 4 per case	<p>IN 2 SIZES!</p> <p>48" 60"</p> <p>Spiral Obelisks Black finish.</p> <table border="1"> <tr><td>83204 / 48 in. H / 4 per case</td></tr> <tr><td>83205 / 60 in. H / 4 per case</td></tr> </table>	83204 / 48 in. H / 4 per case	83205 / 60 in. H / 4 per case	<p>55"</p> <p>Spiral Priory Obelisk Black finish.</p> <table border="1"> <tr><td>82010 / 55 in. H / 4 per case</td></tr> </table>	82010 / 55 in. H / 4 per case	<p>44"</p> <p>Pyramid Finial Obelisk Black finish.</p> <table border="1"> <tr><td>89355 / 44 in. H / 4 per case</td></tr> </table>	89355 / 44 in. H / 4 per case
89328 / 36 in. H / 6 per case													
89327 / 48 in. H / 1 per case													
89326 / 60 in. H / 1 per case													
89357 / 36 in. H / 5 per case													
89356 / 60 in. H / 4 per case													
83204 / 48 in. H / 4 per case													
83205 / 60 in. H / 4 per case													
82010 / 55 in. H / 4 per case													
89355 / 44 in. H / 4 per case													



Windmill Obelisk

With decorative accent final ball – in copper finish

On-trend, matte black finish

<p>64"</p> <p>Modern Farmhouse Folding 3-Panel Obelisk / Trellis With copper accent balls.</p> <table border="1"> <tr><td>83202 / Black / 64 in. H / 1 per case</td></tr> </table>	83202 / Black / 64 in. H / 1 per case	<p>52"</p> <p>Garden Obelisk Black finish.</p> <table border="1"> <tr><td>86810 / 51.5 in. H / 4 per case</td></tr> </table>	86810 / 51.5 in. H / 4 per case	<p>60"</p> <p>Heirloom Rustic Obelisk Rust finish.</p> <table border="1"> <tr><td>83207 / 60 in. H / 4 per case</td></tr> </table>	83207 / 60 in. H / 4 per case	<p>64"</p> <p>Perching Birds Obelisk Black finish.</p> <table border="1"> <tr><td>86803 / 64 in. H / 4 per case</td></tr> </table>	86803 / 64 in. H / 4 per case	<p>IN 3 SIZES!</p> <p>48" 60" 72"</p> <p>Rose Tower Obelisks</p> <table border="1"> <tr><td>89353 / 48 in. H / 1 per case</td></tr> <tr><td>89350 / 60 in. H / 1 per case</td></tr> <tr><td>89358 / 72 in. H / 1 per case</td></tr> </table>	89353 / 48 in. H / 1 per case	89350 / 60 in. H / 1 per case	89358 / 72 in. H / 1 per case
83202 / Black / 64 in. H / 1 per case											
86810 / 51.5 in. H / 4 per case											
83207 / 60 in. H / 4 per case											
86803 / 64 in. H / 4 per case											
89353 / 48 in. H / 1 per case											
89350 / 60 in. H / 1 per case											
89358 / 72 in. H / 1 per case											

<p>72"</p> <p>Windmill Obelisk Black finish.</p> <table border="1"> <tr><td>88840 / 72 in. H / 1 per case</td></tr> </table>	88840 / 72 in. H / 1 per case	<p>72"</p> <p>Armillary Obelisk Black finish.</p> <table border="1"> <tr><td>86805 / 72 in. H / 1 per case</td></tr> </table>	86805 / 72 in. H / 1 per case	<p>72"</p> <p>Rooster Weathervane Obelisk Rust finish.</p> <table border="1"> <tr><td>86806 / 72 in. H / 1 per case</td></tr> </table>	86806 / 72 in. H / 1 per case	<p>48"</p> <p>Rustic Farmhouse Quilt Obelisk Rust finish.</p> <table border="1"> <tr><td>83201 / 48 in. H / 2 per case</td></tr> </table>	83201 / 48 in. H / 2 per case
88840 / 72 in. H / 1 per case							
86805 / 72 in. H / 1 per case							
86806 / 72 in. H / 1 per case							
83201 / 48 in. H / 2 per case							



Perching Birds Obelisk



Modern Farmhouse Folding 3-Panel Obelisk / Trellis

MODERN FARMHOUSE
HOME & GARDEN

New! Compact Hose Storage

Merchandising Program

Mix & Match Hose Hanger + Post System

Each can be wall-mounted or free-standing on a post accessory for flexible and compact merchandising.



Pick one of 6 new styles



STEP 1 PICK A STYLE

Choose a hose hanger (Sold Separately)

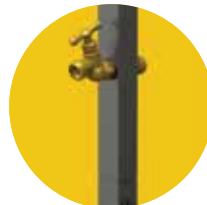

STEP 2 ADD A STAND

Deluxe Hose Hanger Stand with Hose Faucet in box



STEP 3 ATTACH HOSE HANGER TO STAND

Step down on base to drive into the ground.

ATTRACTIVE HOSE STORAGE EASY AS 1 - 2 - 3



Garden Hose Stand

89023 / 48 in. H
Black / 10 per case

**Integrated Post System
Deluxe Hose Stand**
Fits 6 New Style Hose Hangers

Key Hole Mounting for optional hose hanger

Includes brass hose faucet

Rugged in-ground foot

Features a compact color box!

Gothic Deluxe Post Black Hose Stand
84072 / 6 per case

Garden Hose Hanger Stand
84001
41 in. H
Black
2 per case

Fits these Traditional Hangers:

84018
84009
89475
84027
89476
84015
89477

Introducing The Galvanized Vintage Washtub Hose Pot & Planter

3-in-1 Vintage Galvanized Washtub Hose Pot

84070 / 3 per case



Basic Hose Stand

84003
42 in. H
Black
2 per case
With bib

84002
42 in. H /
Black
2 per case
Without bib

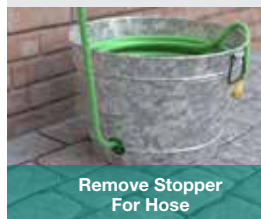

Remove Stopper For Hose



As a trendy galvanized planter

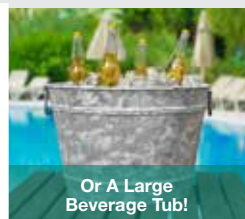

Or A Large Beverage Tub!



6 New Styles + Integrated Post System



Steel Finial Hose Hanger

84077 / 6 per case



Trellis & Scroll 125 ft. Cast Aluminum Wall-Mount Hose Hanger

84067 / 6 per case



Quatrefoil Scroll 125 ft. Cast Aluminum Wall-Mount Hose Hanger

84069 / 6 per case



Steel Hose Hanger

84076 / 6 per case



Basic Heavy-Duty Steel Hose Hanger

84075 / 6 per case



NEW! Plastic Mission Design

150 ft. Mission Collection Plastic Hose Saddle with Sprayer & Storage Cubby

84065 / 6 per case

Traditional Hose Hangers

*See Garden Hose Hanger Stand 84001 on left

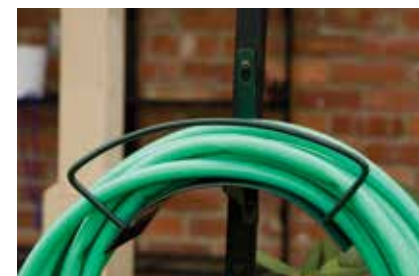

Heavy Duty Hose Hangers

89475 / Green / 6 per case



Olde World Scroll Hose Hanger

89477 / Black / 6 per case



Forged Scroll Hose Hanger

84009 / Black / 4 per case



Finial & Scroll Hose Hanger

84027 / Black / 4 per case



Scroll & Leaf Hose Hanger

89476 / Black / 6 per case



Free-Standing Hose Hanger (see also 89023 on left)

Scroll Hose Hanger

84004 / 48 in. H
Black / 2 per case



Classic Finial Hose Hanger

84018 / Black / 4 per case



Star Hose Hanger

84015 / Black / 4 per case

Watering Cans



IN 2 SIZES!

Traditional Watering Cans
Assorted yellow, green, blue, and red. 2 of each color per case.

84830 / 1 GAL (4L)
8 per case

84832 / 2 GAL (7.5L)
4 per case



1 GAL

Metallic Watering Cans
Assorted green, purple, red, and grey. 2 of each color per case.

84835 / 1 GAL (4L)
8 per case



0.85 GAL

Metallic Trim Watering Cans
Assorted beige, desert green, maroon, and forest green. 2 of each color per case.

84870 / 0.85 GAL (3.2L)
8 per case



0.5 GAL

Polka Dot Watering Cans
Assorted red, green, blue, and yellow. 2 of each color per case.

84892 / 0.5 GAL (1.8L)
8 per case



0.25 GAL

Pastel Watering Cans
Assorted blue, purple, yellow, and pink. 2 of each color per case.

84878 / 0.25 GAL (0.9L)
8 per case



0.65 GAL

Vintage Canister Watering Cans
Assorted black zinc, brushed copper, and aged galvanized. of each color per case.

84862 / 0.65 GAL (2.5L)
6 per case



See Also Our Watering Can Display Options on page 144



0.75 GAL

Gardening Quotes Watering Cans
Assorted red, green, pink, and purple. 1 of each color/saying per case.

84891 / 0.75 GAL (2.8L) / 4 per case



Galvanized Watering Can
With copper accents.

84895 / 2 GAL (7.5L)
4 per case

Vintage Aged Galvanized XL Watering Can

84881 / 3.2 GAL (12L)
4 per case



Vintage Aged Galvanized Watering Can

84882 / 1 GAL (4L)
4 per case

Vintage Aged Galvanized Wood Handle Watering Can

84880 / 2 GAL (7.5L)
4 per case



Vintage Brushed Watering Can

84872 / 2 GAL (7.5L)
4 per case

Vintage Embossed Watering Can

84875 / 2 GAL (7.5L)
4 per case



Rustic Long Reach Watering Can
Black zinc finish.

84837 / 1 GAL (4L)
4 per case

Rustic Embossed Watering Can
Black zinc finish.

84838 / 1 GAL (4L)
4 per case

MODERN FARMHOUSE
HOME & GARDEN



Essential Watering Tools for Succulents, Orchids & Houseplants

Modern Farmhouse Round Watering Can & Mister Gift Set

Modern Farmhouse Mister & Watering Can Boxed Set

84842 / 2 per case
Matte Black with Copper Accents



Features a fat spout and double handles for efficient, less frequent watering trips.



XL Fern Leaf Watering Can
Bronze finish.

84843 / 2.5 GAL (9.5L)
4 per case



Modern Farmhouse Round Black Watering Can

84840 / 0.4GAL (1.5L)
6 per case



Modern Farmhouse Matte Black Mister with Copper Accents
Black finish.

84841 / 3.35 in. Dia. x 5.7 in. H
9.1 oz. capacity / 6 per case



Deluxe Long-Reach Watering Can
Hunter green finish.

84853 / 2 GAL (7.5L)
4 per case

Includes Gold foil elastic tied upscale hangtag with benefits & instructions

New from Panacea – Portable Greenhouses!



Promotionally priced and a better product than similar portable greenhouses!

FITS 2 TRAYS PER SHELF

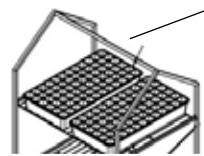

Shelves hold 2 standard seedling trays side-by-side for maximum space efficiency. (seedling trays not included)



Heavy-duty zippers with large pull rings.

Convenient locking wheels provide flexibility to move greenhouse to sunny locations.



Urban Gardener
Economy Portable Greenhouse

82240 / Green / 1 per case

Product Dimensions:
26.75 in. W x 63.75 in. H x 19.25 in. D



Holds standard large seed starter trays.

Tabletop Planter With Grow Lights

Makes a Beautiful Starter Garden – Indoors!

Planter height 5" – can be used as a planter (includes a removable drain plug) for direct planting.

Attractive Copper Accents

Wide 24" double 10 watt LED grow light

Adjustable height grow light



Trendy, pre-galvanized matte black powder coated finish.

Modern Farmhouse Gardener
Indoor Grow Kit – Tabletop Planter with Grow Light

82245 / Matte Black / 1 per case

Product Dimensions: 27.5 in. W x 19 in. H x 11.5 in. D



Great Looking Plant Stand + Greenhouse

Full of Bonus Features!

Copper plated accent balls

Adjustable Shelves

Rugged, pre-galvanized & powder coated matte black steel frame

Plastic trays are included for starting seedlings!

When trays are flooded with water, fiber pots can absorb standing water and root-feed seedlings.

Makes a great-looking shelf plant stand indoors without cover. (Grow lights in deluxe kit give plants a jumpstart!) Then move outdoors early in the season and add greenhouse cover.

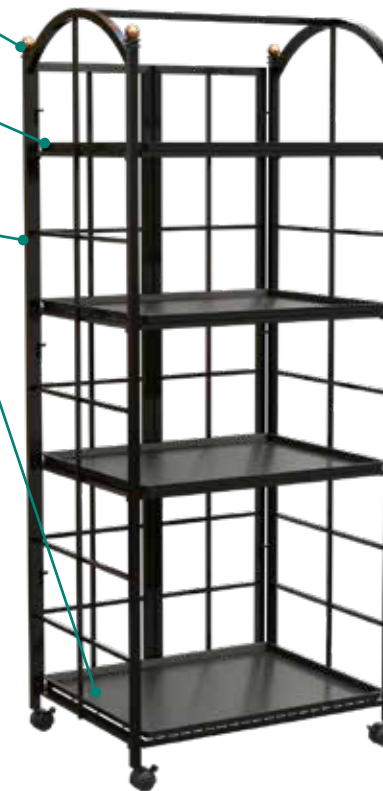

Modern Farmhouse
Premium Adjustable Shelf Plant Stand / Patio Greenhouse

With trays and cover.

82242 / Matte Black / 1 per case

Product Dimensions:
27.5 in. W x 65 in. H x 22 in. D

Modern Farmhouse
Deluxe Kit Adjustable Shelf Plant Stand / Patio Greenhouse with Grow Lights

Includes trays and cover.

82243 / Matte Black / 1 per case

Product Dimensions:
27.5 in. W x 65 in. H x 22 in. D

No Wasted Space!

Shelves are designed to hold two full sets of standard seeding starter trays side-by-side to maximize space.

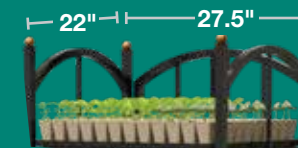

Heavy-Duty Zippers with large pull rings.



4 GROW LIGHTS

24" double 10 watt, efficient LED grow lights included *with deluxe kit.*



Premium
Plant Stand + Greenhouse



Deluxe Kit
Plant Stand + Greenhouse + Grow Lights

Rustic Heirloom Plant Supports & Yard Stakes

Add Rustic Cottage Charm to the Garden!



Rust Botanical Plant Supports / Yard Stakes

All stakes are 30" tall and 6 per case. An optional wire display rack can be purchased separately.

82051 / Poppies
82050 / Fern
82053 / Ivy
82052 / Leaf
90-90428EM / Empty Display Holds 24 plant stakes.



MODERN FARMHOUSE
Gardener

Elegant Plant Supports

Gardening is a labor of love and passionate gardeners know that supporting their climbing or top-heavy plants is the key to success. To accentuate greenery and flowering plants, these Modern Farmhouse-styled plant supports take it to the next level. With beautiful copper-plated ball tops and a thick, matte black texture powder-coated finish, it is easy for plants to grab without sliding down. It's a gardening investment that serious gardeners will proudly make to showcase their prize plantings.

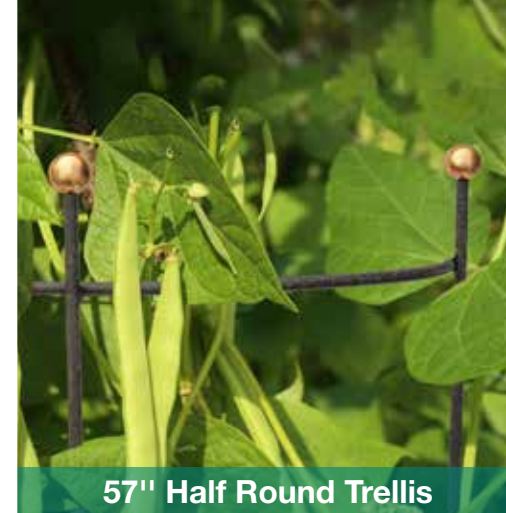

57" Half Round Trellis

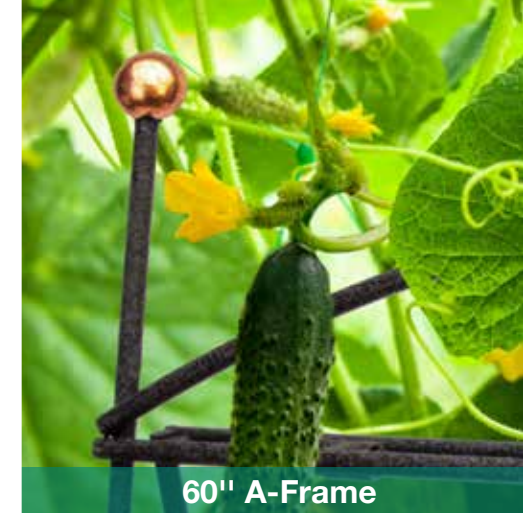

60" A-Frame



50" Tomato Trellis

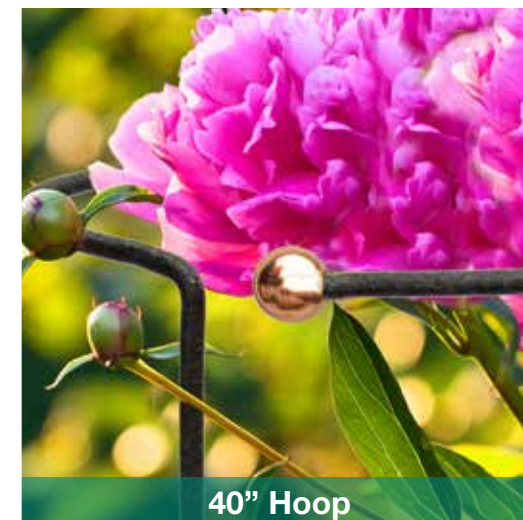

40" Hoop

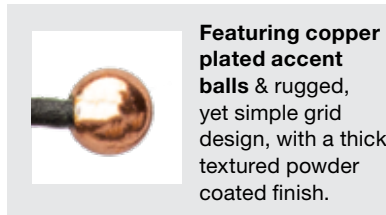

Featuring copper plated accent balls & rugged, yet simple grid design, with a thick textured powder coated finish.

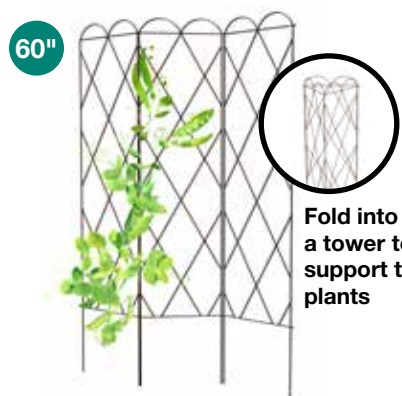

60"

Fold into a tower to support tall plants



60"

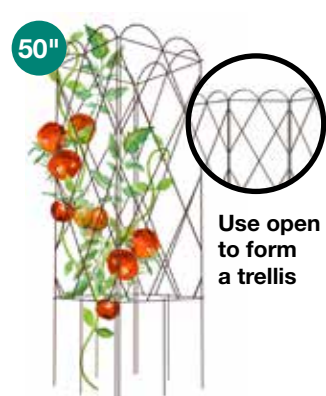

50"

Use open to form a trellis



Great Promo Item!

3 Panel Expandable Pea Trellis

90130 / Rust / 5 per case

Product Dims:
43 in. W (open) x 60 in. H

Folding A-Frame Garden Trellis

90140 / Rust / 6 per case

Product Dims:
18 in. W x 60 in. H

Folding 4-Panel Tomato Tower

90145 / Rust / 6 per case

Product Dims:
14 in. W x 50 in. H

Folding 4-Panel Tomato Tower Display

12 of 90145 on metal wire display rack.

90-90300 / 12PC Display



IN 2 SIZES!



IN 2 SIZES!



60"

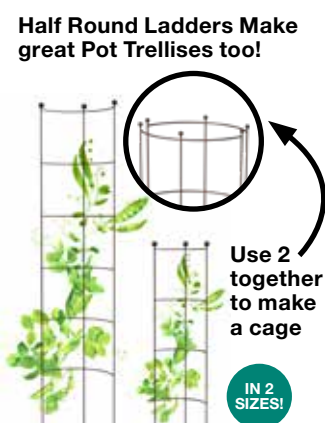

Use 2 together to make a cage

IN 2 SIZES!

Fluted Tomato & Plant Cages

Rust finish. All 5 per case.
16 in. Dia.

90105 / 16 in. Dia. x 36 in. H

90106 / 16 in. Dia. x 54 in. H

Wraparound Hoop Supports

Rust finish. 9 in. Dia.
All 12 per case.

90120 / 20 in. H

90121 / 40 in. H

Spiral Plant Support

Rust finish.
12 per case.

90135 / 60 in. H

Half-Round Vegetable Ladder

Rust finish. All 6 per case.

90102 / 13 in. W x 57 in. H

90101 / 8.75 in. W x 33 in. H

Display up to 60 plant supports in a small footprint



Compact EMPTY Rustic Heirloom Plant Support Display

90-90429EM / EMPTY

Elegant Supports For Flower & Vegetable Plants

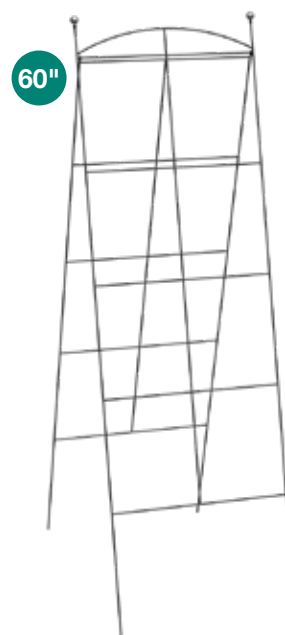

60"

Folding A-Frame Garden Trellis

Matte Black. 6 per case.

83701 / 60 in H

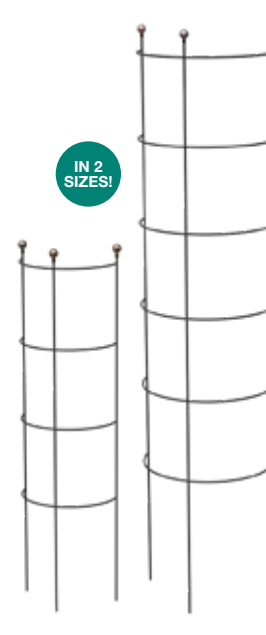

IN 2 SIZES!

Half-Round Vegetable Trellis

Matte Black. All 6 per case.

90097 / 33 in. H

90098 / 57 in. H

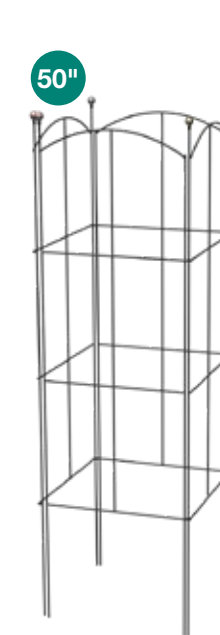

50"

Folding 4-Panel Tomato Trellis

Matte Black. 6 per case.

90091 / 50 in. H

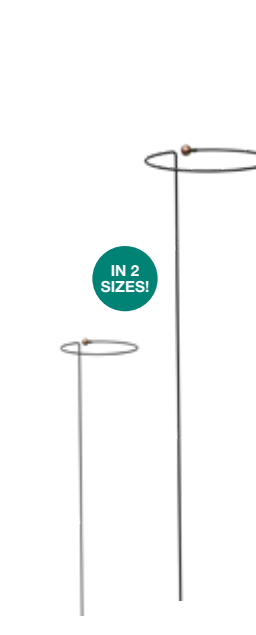

IN 2 SIZES!

Wraparound Hoop Supports

Matte Black. All 12 per case.

90093 / 20 in. H

90094 / 40 in. H



Modern Farmhouse 48PC Plant Support Display

Includes 1 case of each plant support. Display KD boxed w/ cases on pallet - assembly required.

90-90481 / Loaded 48PC

90-90481EM / Empty Build-Your-Own Assortment

Attractive & Functional Plant Care

IN 2 STYLES!



DEER Ideal nibbling protection from rabbits, deer & ground hogs for seedlings like lettuce, spinach and other delicate plants.

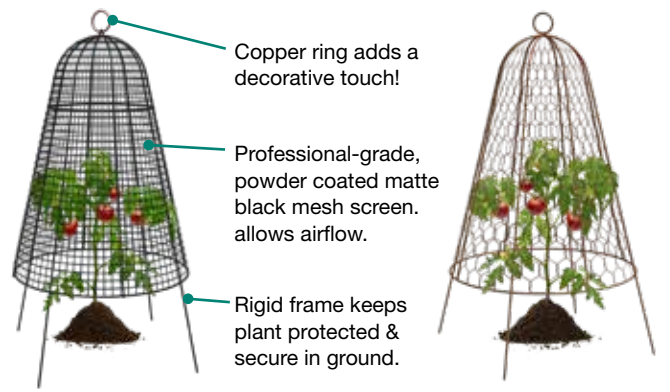

Garden Cloche Plant Protector Bell
Rust finish. All 12 per case.

83281 / Modern Farmhouse / Matte Black / 12 per case

83280 / Rustic Farmhouse / Rust Finish / 12 per case

Product Dims:
14 in. Dia x 20 in. H

Protect Multiple Young Seedlings With This Expandable Cloche.

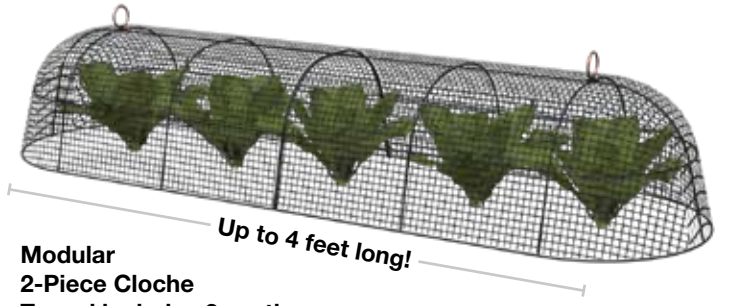

Modular 2-Piece Cloche Tunnel includes 2 sections: each 23.5"L x 13.5"W x 8"H for a combined length nearly 4 feet long!

Eight ground stakes are included with each Modular 2-Piece Cloche Tunnel for a secure ground connection.



The 2-Piece Cloche Tunnel can be turned sideways and connected together to form a 23"H x 16"W wide protective cage as plants grow larger.

Modern Farmhouse Modular 2-Piece Plant Protector Garden Cloche Tunnel

With ground stakes.

83282 / Matte Black / 3 sets per case

Product Dims:
23.5 in. L x 13.5 in. W x 8 in. H



Metal Gardening Caddy

Combining Elegance with Function

Modern Farmhouse
Metal Gardening Caddy
81016 / Matte Black / 4 per case

Product Dims:
11.25 in. W x 10 in. H x 8.25 in. D



Copper Plant ID Tags

Stylish – Indoors and Out!

Modern Farmhouse
Copper Plant ID Tags and Wire Stake
With outdoor marker – 3 pack with storage bag.

81015 / Black
12 sets per case

Product Dims:
Each stake is 9" tall.



Includes outdoor marker & 3 plant markers



Packaged in 3-pack with outdoor marker and storage bag on attractive blister header card. Shipped in display cartons or hang them to display.



Garden Cloche Plant Protectors

MAKES A PRETTY GARDEN! IN 2 FORMATS – BELL AND TUNNEL

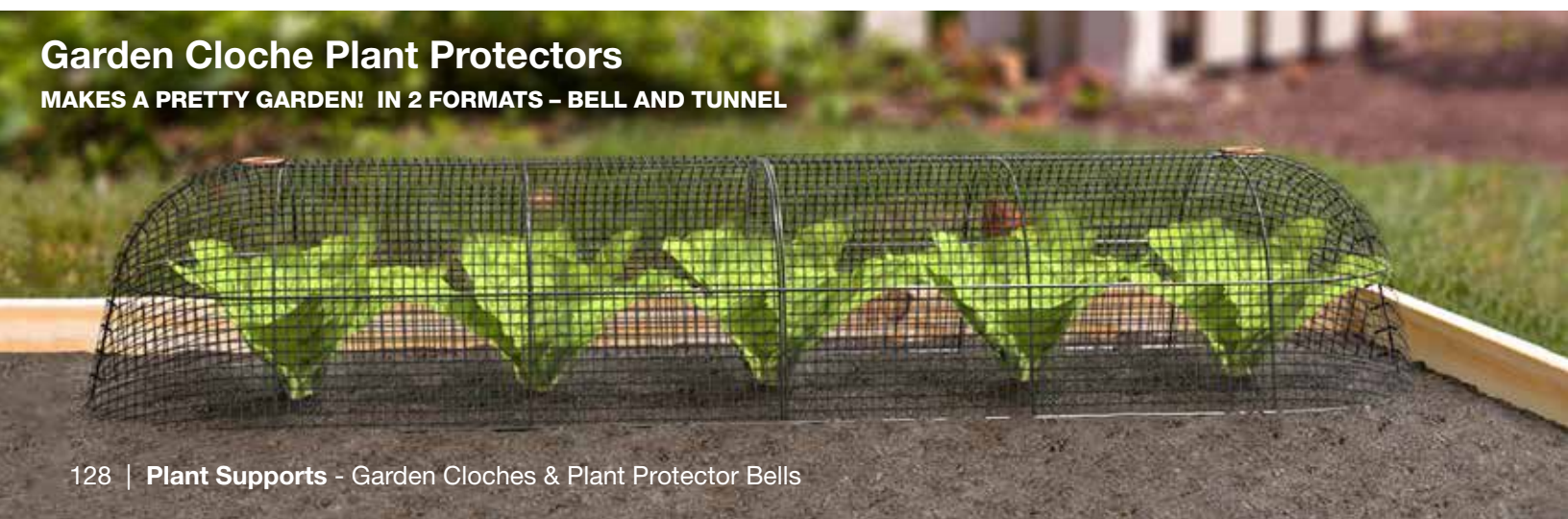

Plant Support Accessories

Compost Bin

Easy to assemble bin with steel stakes. Bin stays secure against wind even on hilly ground.

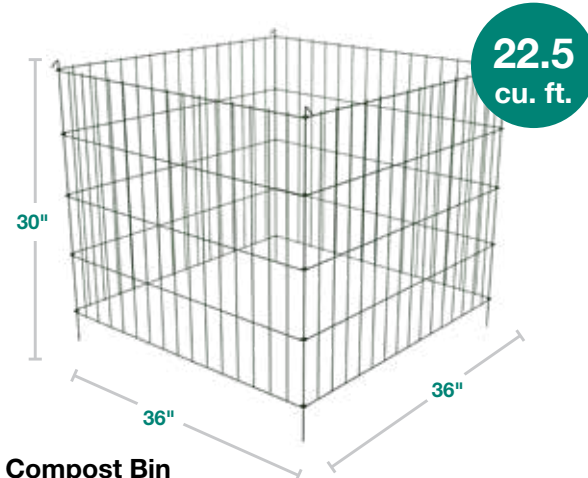

Compost Bin

Holds up to 22.5 cubic feet.

89560 / Green / 5 per case

Product Dims: 36 in. W x 30 in. H x 36 in. D

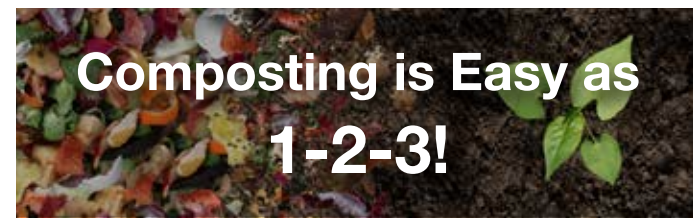

Step 1

Add yard clippings, table scraps, and other organic matter.

Step 2

Place bin on tilled ground, keep moist, and wait.

Step 3

Compost bin will produce rich, dark top soil.



Weatherproof Seed Packet Plant Markers

Now gardeners can display their colorful & informative paper seed packets in the garden without them getting wet and ruined! Long, 12" metal stake displays plant variety with less bending over required & outlasts wood stakes.

Seed Packet Plant Markers

3 per pack.

86875 / Black / 12 per case



Tomato Cage Plant Markers

Includes 3 pack of red, metal tomato-motif tag holders. Keeps names of tomato varieties up high, where gardeners can easily view them. Just bend the decorative metal tomato stem over the edge of a tomato cage to attach.

Tomato Cage Plant Markers

3 per pack.

86820 / Red / 12 per case



Includes 3 metal plant markers & 6 Blanks

(Reversible for up to 12 uses)

Ties, Meters, & Labels



Plastic Plant Tie Ribbon

Green finish.

89790 / 150 ft.
6 per case



Garden Wire

Green finish.

86850 / 50 ft.
12 per case



Garden Twine

Green finish.

86840 / 200 ft.
12 per case



Plant "T" Labels

White finish. 10-Pack.

86843 / 6 in. H
12 per case



Soft Wire Ties

Green finish. 20-Pack.

86841 / 8 in. H
12 per case



Soft Wire Tie

Green finish.

86842 / 32.5 ft. roll
6 per case



Moisture Meter

60181 / 6 per case



Moisture, Light, & pH Meter

60182 / 3 per case



Tree Care Accessories



Large Tree Stakes

Black Finish. 6-Pack.

84141 / 9 in. H
6 per case



Tree Stake Kit

Black Finish. 6-Pack.

84140 / 9 in. H
6 per case



Tree Stake Kit

Black Finish. 6-Pack.

84142 / 15 in. H
6 per case



Colorful Polybag Packaging



Watering Bag

Black Finish.

81220 / 4 per case

- Holds 20 gallons of water
- 4-8 hour drip time - slow release ensures water saturates into roots
- Double Emitters - Distributes water evenly for complete coverage



Tree Bark Guard

81225 / 8 per case

- Protects trees from lawn mower damage, insects & animals
- Adjustable Size - for larger tree trunks, combine 2 together

Plant Support Stakes



PE Coated Metal Plant Stakes

All green.

- 84185 / 2 ft. (8mm) / 50 per case
- 89786 / 3 ft. (11mm) / 50 per case
- 89796 / 4 ft. (11mm) / 50 per case
- 89787 / 5 ft. (11mm) / 50 per case
- 89788 / 6 ft. (11mm) / 50 per case
- 84186 / 6 ft. (16mm) / 25 per case
- 89797 / 7 ft. (16mm) / 25 per case
- 89798 / 8 ft. (16mm) / 25 per case



Hardwood Plant Stakes

- 89780 / 3 ft. H / 6 per bundle - 6/48
- 84176 / 3 ft. H / Single Stake - 25/100
- 89960 / 4 ft. H / 6 per bundle - 24 per case
- 89789 / 4 ft. H / Single Stake - 25/100
- 84175 / 5 ft. H / Single Stake - 25/100
- 89961 / 6 ft. H / Single Stake - 25/100



Bamboo Plant Stakes

- 89783 / 3 ft. / 24 per bundle - 6/36
- 89782 / 4 ft. H / 12 per bundle - 6/24
- 89784 / 5 ft. H / 12 per bundle - 24 per case
- 84180 / 6 ft. H / 6 per bundle - 6/24



Bamboo "U" Hoop Stake Plant Support

All 25 per case. 3-Pack.

- 89945 / 36 in. H
- 89946 / 48 in. H

Spiral Plant Supports

- 89765 / 6ft. Red / 12 per case

Plant Support Displays

The most flexible and complete merchandising solution in a **no-hassle modular format**



Rugged, all weather displays are conveniently shipped on removable skids with handsome metal bins and outdoor signage.

Choose any 5 case packs below to create your own assortment.

PE Coated Metal Plant Stakes (GREEN)

Item#	Description	CASE
89786	3 ft. (11 mm)	50
89796	4 ft. (11 mm)	50
89787	5 ft. (11 mm)	50
89788	6 ft. (11 mm)	50
89797	7 ft. (16 mm)	50
89798	8 ft. (16 mm)	50

Bamboo Plant Stakes

Item#	Description	CASE
89781	2 ft. (25 individual)	6
89783	3 ft. (24 individual)	6
89782	4 ft. (12 individual)	6
89784	5 ft. (12 individual)	6

Hardwood Plant Stakes

Item#	Description	CASE
89780	3 ft. (6 Individual)	6
89789	4 ft. (Individual)	25
89961	6 ft. (1"sq. Individual)	25

Metal Plant Supports (GREEN)

Item#	Description	CASE
89325	18 in. Support	24
89330	24 in. Support	24
89335	28 in. Support	24
89340	36 in. Support	24
89792	4 ft. Swirl Support	24
89798	8 ft. (16 mm)	25

More Plant Support Displays

Plant Support Displays are also able to accommodate accessories shown on page 131.

Ask your Panacea Products representative for more plant support display options.

Free Display with purchase of 5 case packs

To order the metal bin display with signage: Use item #90-90036MN, Empty Plant Support Display

Plant Support Hoops, Rings, & Half-Rounds

Half-Round Plant Supports

Keeps Plants from Dropping Into Pathways.

Half-Round Supports

All 25 per case with green finish.

- 84104 / 6 in. W x 17 in. H
- 84105 / 8 in. W x 22 in. H
- 89341 / 12 in. W x 30 in. H
- 84107 / 15 in. W x 30 in. H
- 84106 / 12 in. W x 34 in. H
- 89342 / 18 in. W x 36 in. H
- 84108 / 16 in. W x 40 in. H

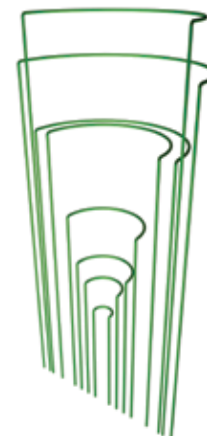

Peony Rings & Grow Through Supports

For Peonies, Perennials, & More!

Available In 3 Heights

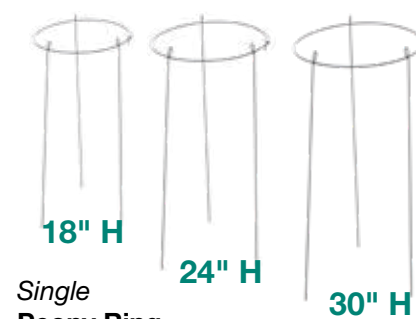

Single Peony Ring

Collapsible. Green finish.

- 89338 / 36 per case / 10 in. Dia. x 18 in. H
- 89321 / 6 per case / 14 in. Dia. x 24 in. H
- 89339 / 12 per case / 18 in. Dia. x 30 in. H

Available In Galvanized or Green

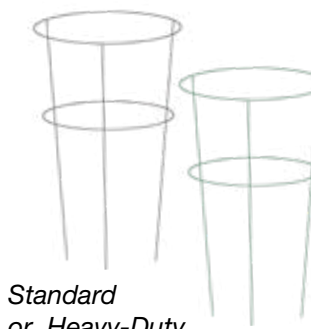

Standard or Heavy-Duty Double Peony Ring

- 89720 / STANDARD / Galvanized 25 per case / 18 in. Dia. x 30 in. H
- 89719 / HEAVY-DUTY / Green 25 per case / 18 in. Dia. x 30 in. H

Available In 2 Heights

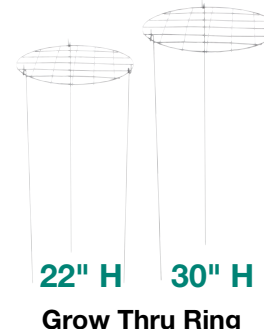

Grow Thru Ring

Collapsible.

- 89323 / 24 per case 14 in. Dia. x 22 in. H
- 89320 / 24 per case 20 in. Dia. x 30 in. H

36"

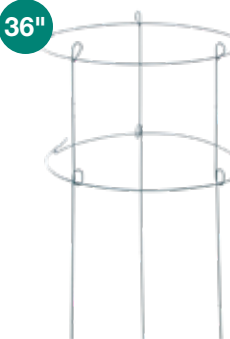

Double Peony Ring

Collapsible. Green finish.

- 89322 / 24 per case 18 in. Dia. x 36 in. H

Plant Supports & Gathering Rings

Support for Delicate, Top-Heavy Plants

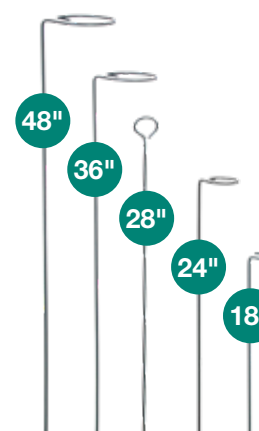

IN 2 SIZES!

Plant Supports

All 24 per case with green finish.

- 89325 / 18 in. H
- 89330 / 24 in. H
- 89335 / 28 in. H
- 89340 / 36 in. H
- 89343 / 48 in. H



Clasp-lock design allows installation around plants.

Gathering Rings

All 24 per case with green finish.

- 89344 / 6 in. Dia x 36 in. H
- 89345 / 8 in. Dia. x 36 in. H
- 89346 / 6 in. Dia. x 48 in. H

FOR INDOOR PLANTS TOO!

12"



3 Leg Potted Plant Support

24 per case.

- 86880 / 5 in. Dia. x 12 in. H



4-Panel
Tomato Tower with Display Box

DISPLAYS AVAILABLE!

Tower Plant Supports

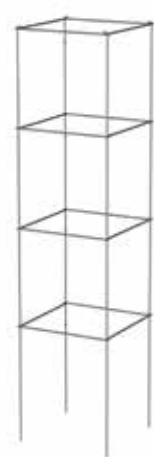

4-Panel
Tomato Tower

Includes display box.

89730 / Galvanized / 46 in. H / 25 per case



Folding Professional
Tomato Cage

All 10 per case with Galvanized finish.

89713 / 18 in. W x 60 in. H
Galvanized / 10 per case

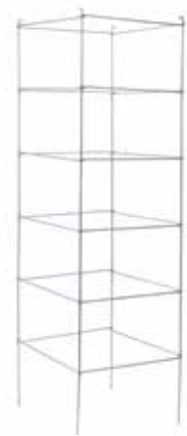

Great for climbing peas or supporting small top-heavy plants



3-Panel
Tomato Tower

89305 / Green
33 in. H / 25 per case

89310 / Green
47 in. H / 25 per case

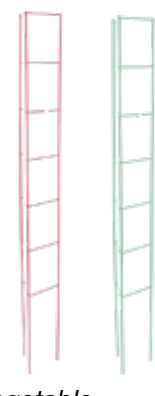

Vegetable
Corner Trellis

89766 / Red
57 in. H / 6 per case

89866 / Light Green
57 in. H / 6 per case

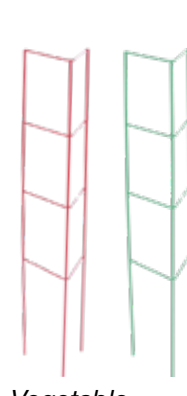

Vegetable
Corner Trellis

89767 / Red
33 in. H / 6 per case

89867 / Light Green
33 in. H / 6 per case

Inverted Plant Supports

Not Just For Tomatoes!

Cucumbers Love Climbing Up
These Inverted Cages - Saves Space Too!



Inverted
Plant Support

5 ring, 4 leg.
15 per case, 60 per pallet.

89763 / Red
54 in. H

89769 / Galvanized
54 in. H



Inverted
Plant Support

4 ring, 3 leg.
25 per case, 200 per pallet.

89762 / Red
36 in. H

89768 / Galvanized
36 in. H



Inverted
Plant Support

4 ring, 4 leg.

89706 / Red
48 in. H / 10 per case



Inverted
Plant Support

5 ring, 4 leg.

89708 / Galvanized
48 in. H / 10 per case



Inverted
Plant Support

4 ring, 4 leg.

89707 / Light Green
48 in. H / 10 per case



Inverted
Plant Support

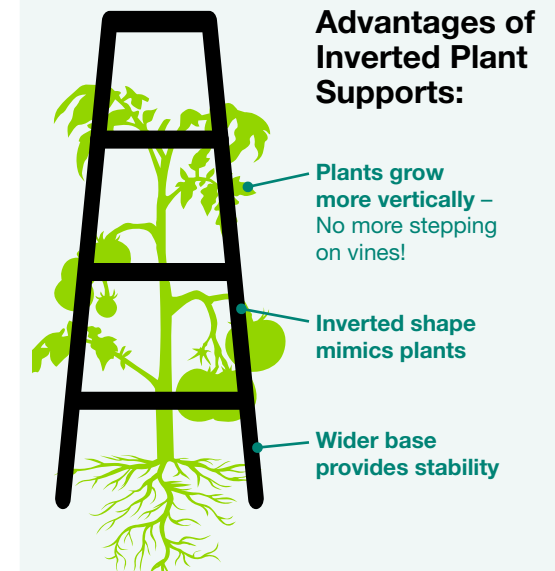

Popular Display!

20 Piece Tomato Tower Display

Order several for multiple strategic areas in your store.

4-Panel Tomato Tower Display
Includes 10 each of **89764** and **89864** with metal wire display rack.

90-90058
20 PC Display

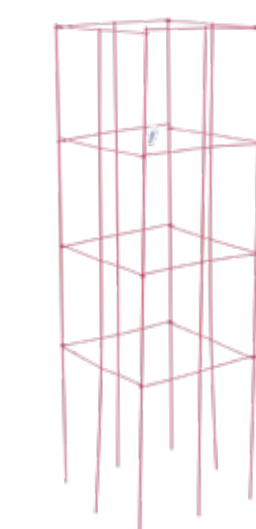

Red Heavy-Duty
4-Panel
Tomato Tower

89764 / Red
47 in. H / 10 per case



Green Heavy-Duty
4-Panel
Tomato Tower

89864 / Light Green
47 in. H / 10 per case



A-Frame
Plant Support

A-Frame Plant Supports

Great for Climbing Vine Plants!



A-Frame
Plant Support

83710
Galvanized
18 in. W x 48 in. H
10 per case



A-Frame
Plant Support

83712 / Light Green
48 in. H / 10 per case

83711 / Red
48 in. H / 10 per case

Great companion to Tomato Tower display (on opposite page) for cucumbers and many other climbing plants.

A-Frame
Plant Support Display

Includes 10 each of **83711** and **83712** with metal wire display rack.

90-90231 / 20-PC Display



Galvanized Tomato Cages

Letter	Item #	Description	Finish	# of Rings	# of Legs	Top Ring Diameter	Bundle Qty	Pallet Qty
A	89723	33" Cage	Galvanized	3	3	12"	25	1500
A	89724	42" Cage	Galvanized	3	3	12"	25	900
C	89729	42" Cage	Galvanized	4	3	14"	25	600
A	89748	42" Heavy-Duty	Galvanized	3	3	16"	25	200
A	89725	54" Promotional	Galvanized	3	3	16"	25	450
B	89726	54" Standard	Galvanized	4	4	16"	25	450
B	89733	54" Heavy-Duty	Galvanized	4	4	16"	15	180
B	89739	54" Professional	Galvanized	4	4	16"	20	80
B	89728	60" Widemouth	Galvanized	4	4	18"	15	150
A	89734	42" Cage	Green	3	3	12"	25	900
B	89727	54" Standard	Green	4	4	16"	25	450

3 Ring / 3 Leg

4 Ring / 4 Leg

4 Ring / 3 Leg



A



B



C



Specialty Mixed Tomato Cage Pallets

Galvanized Tomato Cage

260
PIECE

620-PC Heavy-Duty Mixed Pallet #89896

Item#	Description	QTY
89729	Tomato Cage 42" X 14" - 4R3L UPC 093432897294	150
89733	HD Tomato Cage 54" X 16" - 4R4L UPC 093432897331	60
89739	Professional Tomato Cage 54"X16" - 4R4L UPC 093432897393	20
89728	Widemouth HD Tomato Cage 60"X18" - 4R4L UPC 093432897287	30
Total number of product pieces on pallet		260

Galvanized Tomato Cage

750
PIECE

750-PC Mixed Pallet #89894

Item#	Description	QTY
89723	Tomato Cage 33" X 12" - 3R3L UPC 093432897232	375
89729	Tomato Cage 42" X 14" - 4R3L UPC 093432897232	225
89726	Professional Tomato Cage 54"X16" - 4R4L UPC 093432897263	150
Total number of product pieces on pallet		620

Galvanized Tomato Cage

425
PIECE

425-PC Mixed Small Pallet #89892

Item#	Description	QTY
89723	Tomato Cage 33" X 12" - 3R3L UPC 093432897232	225
89729	Tomato Cage 42" X 14" - 4R3L UPC 093432897294	150
89726	Tomato Cage 54" X 16" - 4R4L UPC 093432897263	50
Total number of product pieces on pallet		425

Powder-Coated Color Tomato Cages

Available In Multiple Colors, Sizes, Pallet Configurations And Price Points

Sold by **Individual Color** – Case Pack & Pallet Options



Vibrant Red
Heavy-Duty
Tomato Cages

Vibrant Yellow
Heavy-Duty
Tomato Cages

Vibrant Green
Heavy-Duty
Tomato Cages

Vibrant Blue
Heavy-Duty
Tomato Cages

Black
Heavy-Duty
Tomato Cages

Size	Item# / Description	Item# / Description	Item# / Description	Item# / Description	Item# / Description
33"	89776 / 3 Ring, 3 Leg 12 in. Dia. x 33 in. H 25 per bundle 400 per pallet	89778 / 3 Ring, 3 Leg 12 in. Dia. x 33 in. H 25 per bundle 400 per pallet	89777 / 3 Ring, 3 Leg 12 in. Dia. x 33 in. H 25 per bundle 400 per pallet	89779 / 3 Ring, 3 Leg 12 in. Dia. x 33 in. H 25 per bundle 400 per pallet	
	89771 / 3 Ring, 3 Leg 16 in. Dia. x 42 in. H 25 per bundle 200 per pallet	89773 / 3 Ring, 3 Leg 16 in. Dia. x 42 in. H 25 per bundle 200 per pallet	89772 / 3 Ring, 3 Leg 16 in. Dia. x 42 in. H 25 per case 200 per pallet	89774 / 3 Ring, 3 Leg 16 in. Dia. x 42 in. H 25 per bundle 200 per pallet	89775 / 3 Ring, 3 Leg 16 in. Dia. x 42 in. H 25 per bundle 200 per pallet.
42"	89754 / 4 Ring, 4 Leg 16 in. Dia. x 54 in. H 30 per bundle 120 per pallet	89756 / 4 Ring, 4 Leg 16 in. Dia. x 54 in. H 30 per bundle 120 per pallet	89755 / 4 Ring, 4 Leg 16 in. Dia. x 54 in. H 30 per bundle 120 per pallet	89757 / 4 Ring, 4 Leg 16 in. Dia. x 54 in. H 30 per bundle 120 per pallet	89760 / 4 Ring, 4 Leg 16 in. Dia. x 54 in. H 30 per bundle 120 per pallet

Sold as **Mixed Color Assortments** - Case Pack & Pallet Options



Heavy-Duty Assorted Color Tomato Cages
Red, yellow, blue, and green finishes.

33"	89900 / 3 Ring, 3 Leg 12 in. Dia. x 33 in. H 25 per bundle, 400 per pallet
42"	89901 / 3 Ring, 3 Leg 16 in. Dia. x 42 in. H 50 per bundle, 200 per pallet
54"	89902 / 4 Ring, 4 Leg 16 in. Dia. x 54 in. H 30 per bundle, 120 per pallet

Promotional Assorted Color Tomato Cages
Red, yellow, blue, and green finishes.

42"	89903 / 3 Ring, 3 Leg 14 in. Dia. x 42 in. H 75 per bundle, 300 per pallet
-----	--

* Promotional Tomato Cages Use a Smaller, 14" Top Ring Size.

Heavy Duty 42" & 54" Cages
Have A 16" Large Top Ring Diameter To Provide Ample Growing Space

16"



Our Most Popular Color Tomato Cage Pallet Assortments



200-PC Vibrant Color
42" x 16" / 3 Ring, 3 Leg
Heavy-Duty Tomato Cage Pallet Display

200
PIECE

Display# 89901

Item#	Description	QTY
89771	42" Red Tomato Cage	50
89772	42" Green Tomato Cage	50
89773	42" Yellow Tomato Cage	50
89774	42" Blue Tomato Cage	50

120-PC Vibrant Color
54" x 16" / 4 Ring, 4 Leg
Heavy-Duty Tomato Cage Pallet Display

120
PIECE

Display# 89902

Item#	Description	QTY
89754	54" Red Tomato Cage	30
89755	54" Green Tomato Cage	30
89756	54" Yellow Tomato Cage	30
89757	54" Blue Tomato Cage	30

Here are a few of our most popular color tomato cage pallet configurations.

Ask your Panacea representative for other alternatives & mixes if these do not meet your merchandising goals.



Single Color Promotional Pallet Displays

(See Display# by color below)

300-PC Promotional Pallet
42" x 14" / 3 Ring, 3 Leg

300
PIECE

DISPLAY#	Description	QTY
83811	Red, 25 per bundle	300/Pallet
83812	Green, 25 per bundle	300/Pallet
83813	Yellow, 25 per bundle	300/Pallet
83814	Blue, 25 per bundle	300/Pallet



Mixed Color Promotional Pallet Displays

300-PC Promotional Pallet
42" x 14" / 3 Ring, 3 Leg

300
PIECE

Display# 90150

Item#	Description	QTY
83811	Red, 25 per bundle	75
83812	Green, 25 per bundle	150
83816	Black, 25 per bundle	75



Brilliant Tomato Cages
Add Sparkle To Your Garden!

NEW! Metallic Finish

Available In 2 Sizes: 42" & 54"

Electric Blue Emerald Green Ruby Red Lightning Purple



Brilliant Color 42" Tomato Cage
200 PC Pallet Display #89904

200
PIECE

Item#	Description	QTY
89904B	42" Electric Blue Tomato Cage	50
89904G	42" Emerald Green Tomato Cage	50
89904R	42" Ruby Red Tomato Cage	50
89904P	42" Lightning Purple Tomato Cage	50

Brilliant Color 54" Tomato Cage
120 PC Pallet Display #89906

120
PIECE

Item#	Description	QTY
89906B	54" Electric Blue Tomato Cage	30
89906G	54" Emerald Green Tomato Cage	30
89906R	54" Ruby Red Tomato Cage	30
89906P	54" Lightning Purple Tomato Cage	30

Shepherd Hook Displays

Loaded 72-PC Round Stock Shepherd's Hook Display

72
PIECE

Item#	Description	QTY
89003	64" Single Shepherd Hook, Black	20
89024	36" Single Shepherd Hook, Black	12
89031	84" Single Shepherd Hook, Black	10
89032	84" Single Shepherd Hook, Offset Black	10
89034	48" Single Shepherd Hook, Black	20
Total number of product pieces on display		72



Our C-Base Display Fixture allows you to create your own assortment of shepherd hooks.

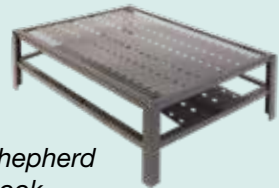

Shepherd Hook Display C-Base

89067 / Black / Empty Display

Loaded 92-PC Assorted Shepherd's Hook Display

90-90430

92
PIECE

Item#	Description	QTY
89024	Shepherd Hook 36" Single, Black	12
89034	Shepherd Hook 48" Single, Black	20
89003	Shepherd Hook 64" Single, Black	20
89031	Shepherd Hook 84" Single, Black	20
89032	Shepherd Hook 84" Double Offset, Black	20
89067	Shepherd Hook Stand	1
Total number of product pieces on display		92

Loaded 60-PC Old World Forged Square Stock Shepherd's Hook Display

60
PIECE

Item#	Description	QTY
89439	64 in. Single Forged Hook	20
89440	84 in. Single Forged Hook	10
89442	84 in. Double Offset Forged Hook	10
89438	48 in. Single Forged Hook	20
89067	Shepherd Hook Stand	1
Total number of product pieces on display		60



Loaded 40-PC Square Tube Decorative Shepherd's Hook Assortment

40
PIECE

Item#	Description	QTY
89135	Shepherd Hook 84" Leaves	10
89138	Shepherd Hook 84" Romantic Single	10
89139	Shepherd Hook 84" Romantic Double	10
89136	Shepherd Hook 84" With Teardrop Finial	10
89067	Shepherd Hook Stand	1
Total number of product pieces in assortment		40

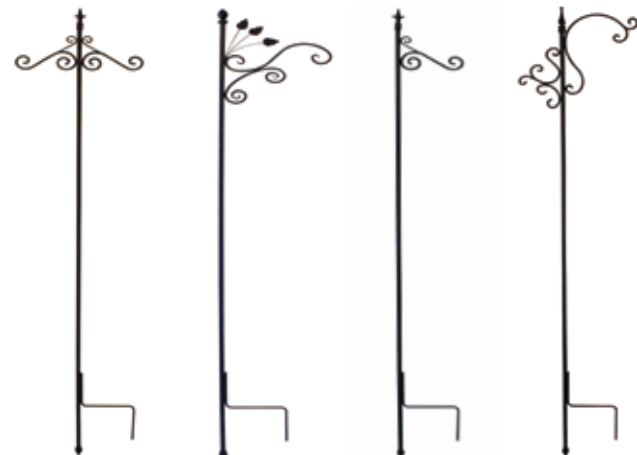

Weather-vane Build-Your-Own Shepherd's Hook Display

Holds up to 20 pieces.

90-90281EM / EMPTY

See Page 75 For Customizing Options!

Hanging Basket Displays



Single Stack Basket Display

*Fits most 12"/14" round baskets

90-90020 (Empty) / Black

Great For High-Volume Styles!

Like Our Finial Hanging Baskets #88512

Multi-Purpose Hanging Baskets, Troughs, & Coco Liners Display

Multi-Basket Display

*This flexible display can hold round, square and trough baskets + coco liners.

90021 (Empty) / Black

See Hanging Baskets, Troughs & Coco Liner pages for customizing options.

Can Be Used For Hanging Baskets, Troughs, & Coco Liners



Loaded 24-Piece Woven Resin Hanging Basket Display

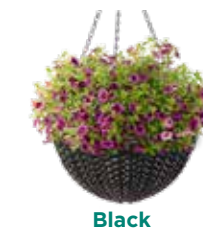

Black



Espresso Brown



Natural Wicker



Grey

Resin Wicker Hanging Basket Display

Includes 6 of each color shown.

82300 / Asst. Colors / 24 piece

GREAT PROMO DISPLAY!

Plant Caddy Displays



Heavy Weight™ Plastic Caddy Display

Contains display and 12 of 84746.

90-90307
12 PC Loaded

Heavy Weight™ Pre-Loaded Plastic Caddy Display -Or- Build-Your-Own

Contains display and 1 case each of 89163, 89167, & 89168.

90-90175 / 36-PC
12 of each size

90-90175EM / EMPTY
See Page 68 For Customizing Options!



Bulk Coco Liner Roll Display



Bulk Roll Display

90-90052 / Loaded (Includes one ea. of 88588 and 88589)

90-90026 / Empty

Trellis Displays

Loaded 36-PC
Wood Trellis Display

36
PIECE

Item#	Description	QTY
82425	72" Wood Fan Garden Trellis, Brown	6
83735	72" Wood Fan Garden Trellis, White	6
82426	72" Wood Ladder Garden Trellis, Brown	6
83736	72" Wood Ladder Garden Trellis, White	6
81914	72" Wood Square Framed Trellis, Brown	6
81913	72" Wood Square Framed Trellis, White	6
90-89400	4 Trellis Display Unit	1
Total product pieces in display		36



Empty Trellis Display

This empty trellis display can be used to display both metal and wood trellises.



Empty Build-Your-Own 4-Way Trellis Display

A 4-way rack to display your trellises.

90-89400
Empty Display



Empty Border Edge Display

This empty border edge display can be used to display 6-8 styles of border edge - 1 case per hook.



Empty Build-Your-Own Border Edge Display

89073
Empty Display

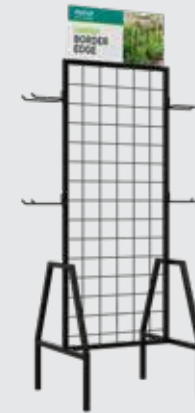

Fence Displays

36
PIECE



Includes stabilizer foot stake, for rigid installation.
36-PC French Country XL Grid Fence Display
90-90274 / 36 Pieces

Compact, Multi-Purpose Grid Fence Display

132
PIECE



Loaded 20-PC
Romantic Trellis Assortment

20
PIECE

Item#	Description	QTY
89676	84" X 24" Romantic Curved Fan	5
89675	72" X 24" Offset Trellis W/ Fin Bk	5
89643	80" X 24" French Arch W/ Fin Bk	5
89634	72" X 18" Arch W/Finials Bk	5
90-89400	4 Trellis Display Unit	1
Total number of product pieces in assortment		20

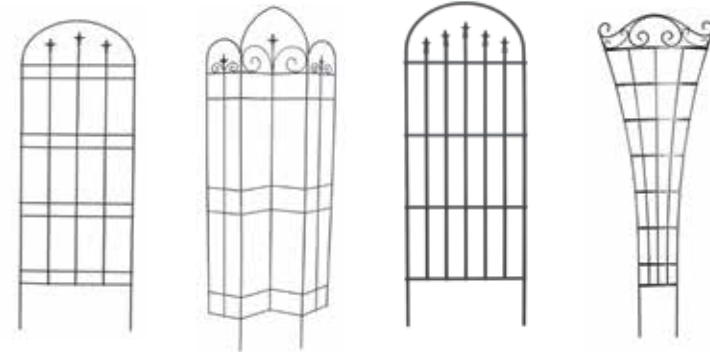

Loaded 20-PC
Curved Trellis Assortment

20
PIECE

Item#	Description	QTY
89677	72" Romantic Curved Trellis	5
89656	72" x 20" Semi-Round Trellis	5
89657	72" x 10" Semi-Round Trellis	5
89658	72" Offset Spires Trellis	5
90-89400	4 Trellis Display Unit	1
Total number of product pieces in assortment		20

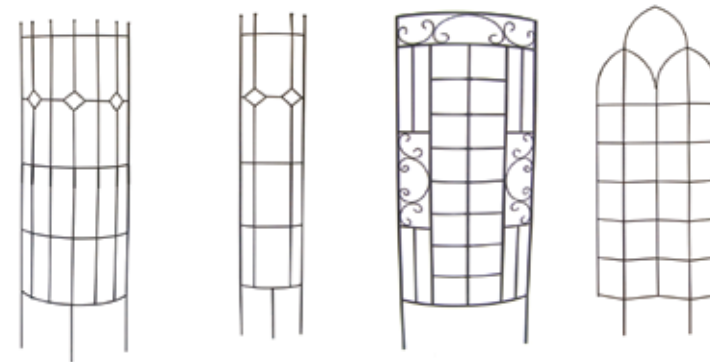

Loaded 37-PC
Economy Trellis Assortment

37
PIECE

Item#	Description	QTY
89075	60" Fan Trellis - Green	10
89076	60" Arched Trellis - Green	10
89637	60" Wave Trellis - Green	12
89633	84" Romantic Fan Trellis - Green	5
90-89400	4 Trellis Display Unit	1
Total number of product pieces in assortment		37

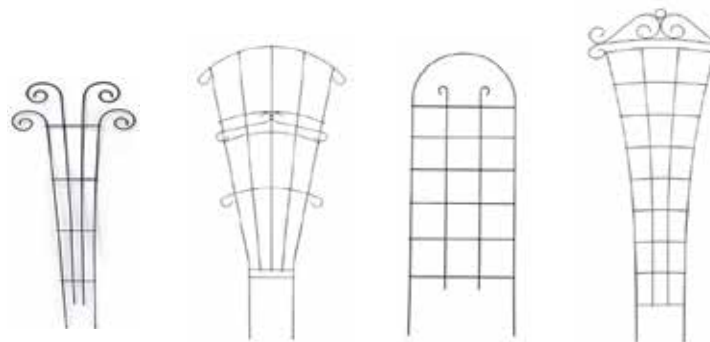

132-PC Compact
Multi-Purpose Grid Fence Display

90-90425EM / (EMPTY, Build-Your-Own Assortment)

90-90425 / (LOADED, includes the below products)

Item#	Description	QTY
81800	Large Multi-Purpose Grid Fence Panel	24
81801	Small Multi-Purpose Grid Fence Panel	24
81802	Small Multi-Purpose Grid Fence Post Stake	36
81803	Large Multi-Purpose Grid Fence Post Stake	36
81804	Small Multi-Purpose Grid Fence Latch Post Stake	6
81805	Large Multi-Purpose Grid Fence Latch Post Stake	6

Total number of product pieces on display 132

Sectional Fence Displays In 3 Styles:

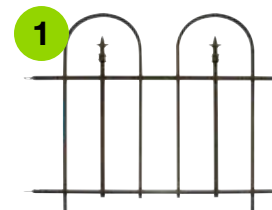

109-PC
Sectional Fence Display
Arched Fial (SHOWN)
Display# 87238

Garden Fence Post
60pcs - 87299
Arched Fial Section
40pcs - 87230
Arched Fial Gate
3 pcs - 87231
Arched Fial End Panel
6 pcs - 87232

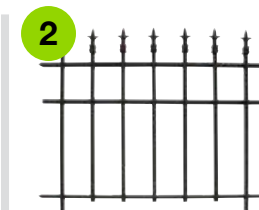

109-PC
Sectional Fence Display
Classic Fial
Display# 87108

Garden Fence Post
60pcs - 87102
Classic Fial Section
40pcs - 87103
Classic Fial Gate
3 pcs - 87104
Classic Fial End Panel
6 pcs - 87105

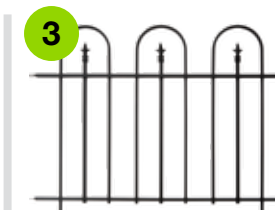

93-PC
Sectional Fence Display
Triple Arched Fial
Display# 90016

Garden Fence Post
54pcs - 87599
Triple Fial Section
36pcs - 87500
Triple Fial Gate
3 pcs - 87501



Display# 87238

Watering Can Displays

In 3 Options, All Including Display Rack & Signage

Standard Assortment



44
PIECE

Loaded 44-PC Watering Can Display
90-90183

Item#	Description	QTY
84830	1 GAL Vibrant Assorted Colors	16
84832	2 GAL Vibrant Assorted Colors	20
84872	2 GAL Rustic Copper	8
Total number of product pieces on display		44

Empty Build-Your-Own Display

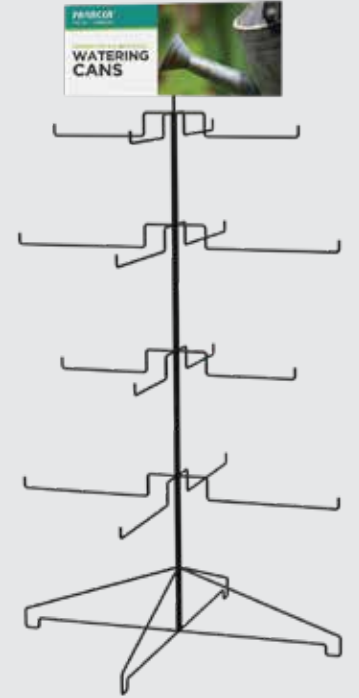

Empty, Build-Your-Own Watering Can Displayer
90-90165

Item#	Description	QTY
90-90165	Metal Displayer and Signage	1
Display Can Capacity		44

See Page 122-123 For Customizing Options!

Vintage Watering Can Assortment



Loaded 28-PC Vintage Watering Can Display
90-90289

Item#	Description	QTY
84881	3.2 Gal Extra Large Vintage Galvanized	4
84882	1 Gal Vintage Aged Galvanized	4
84880	2 Gal Vintage Galvanized w/ Wood Handle	4
84872	2 Gal Brushed Bronze	4
84875	2 Gal Embossed Brushed Copper	4
84837	1 Gal Rustic Long Reach, Black Galvanized	4
84838	1 Gal Embossed, Black Galvanized	4
Total number of product pieces on display		28

Raised Garden Bed Displays

Holds up to 16 selling units and takes only minutes to set-up. No tools needed! Mix & match colors and/or ground & stand-up versions.



Urban Gardener No Tools Metal Raised Bed Floor Display
90-90323 / EMPTY

Display Dimensions: 48 in. W x 12 in. H x 27 in. D

HOLDS UP TO 16 UNITS

Rack available to support raised bed accessories upon request. (see 83830 & 83831 on pg. 11)



Totally customizable, this NO TOOLS Urban Gardener® Metal Raised Bed display model is a great way for consumers to touch and feel the quality of this product line. It can hold 8-16 selling units in various color options as well as elevated and ground models. The empty display model includes a large, eye-catching Urban Gardener sign label. A rack for holding raised bed accessories is also available. Your Panacea representative will be happy to suggest various display options using this empty floor model display.

Vintage Grow Bags Display



Feed & Seed / Rooster **Flour Bag** **Coffee Bag** **Feed & Seed / Pig**



36
PIECE

Loaded 36-PC 10 GAL Feed & Seed, Flour, & Coffee Vintage Grow Bags Display
90-90317 / Includes 3 cases of 84399 / Total of 36 grow bags



A TOP SELLER!

Loaded 24-Piece Beverage Stakes Display

Loaded 24-PC Beverage Stakes Display
Assorted colors of red, green, blue, and yellow. Shipped in attractive 24 piece display. Six each of the four colors included.

87995 / Assorted Colors / 24 per case

Product Dimensions: 4.5 in. W x 36 in. H x 3.25 in. D
Display Dimensions: 17.5 in. W x 36.8 in. H x 7.5 in. D

4 Assorted Colors:
Red Green Blue Yellow

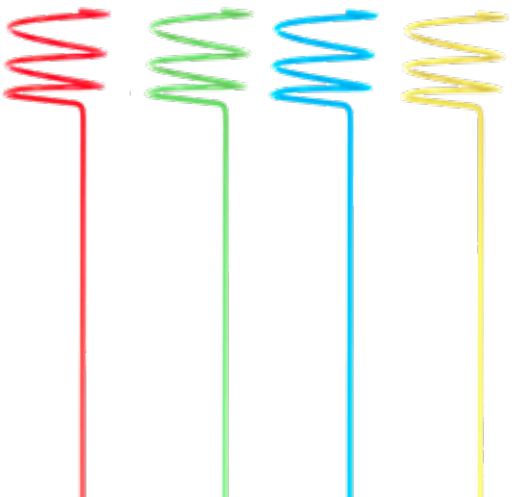

Designer Collection Displays



Add On-Trend Styling to your Garden Decor Assortment



EMPTY, BUILD-YOUR-OWN or Loaded 58-PC Modern Farmhouse Planter / Container Display

Item#	Description	QTY
90-90451EM	(EMPTY, Build-Your-Own Assortment)	
90-90451	(LOADED, includes the below products)	
81421	Modern Farmhouse 8" Wire Bushel Basket W/ Bistro Print	12
81426	Modern Farmhouse 8" Washtub Planter	12
81422	Modern Farmhouse 10" Wire Bushel Basket W/ Bistro Print	6
81427	Modern Farmhouse 10" Washtub Planter	6
81428	Modern Farmhouse 14" Washtub Planter	6
81424	Modern Farmhouse 16" Oval Wire Bushel Basket W/ Bistro Print	6
81429	Modern Farmhouse 16" Oval Washtub Planter	6
84842	Modern Farmhouse Mister & Watering Can Gift Set	4
-	Black Fixture Display With Signage	1
Total number of product pieces on display		58



Timeless, White Enamelware-Inspired Vintage Planters

EMPTY, BUILD-YOUR-OWN or Loaded 58-PC Milkhouse Collection

Item#	Description	QTY
90-90385EM	(EMPTY, Build-Your-Own Assortment)	
90-90385	(LOADED, includes the below products)	
82618	16" Milkhouse Vintage Milk Can Planter & Plant Stand, Farm Fresh Milk	4
82610	8" Milkhouse Vintage Bucket Planter #1, With Wood Handle	6
82611	10" Milkhouse Vintage Bucket Planter #2, With Wood Handle	6
82612	14" Milkhouse Vintage Bucket Planter #3, With Wood Handle	6
82613	16" Milkhouse Vintage Oval Planter, Feed & Seed	6
82614	9" Milkhouse Vintage Vase	6
82615	7.5" Milkhouse Vintage Farm Animal Bucket Planters, Assorted	20
82617	12" H (2.5l/6gal) Milkhouse Pitcher Watering Can, Milkhouse Series	4
-	Black Fixture Display With Signage	1
Total number of product pieces on display		58



Removable Lid



Loaded 61-PC Modern Farmhouse Garden Decor Display

Item#	Description	QTY
90-90452	(LOADED, includes the below products)	
81431	Modern Farmhouse 84" Trellis, With Copper Accents	5
81432	Modern Farmhouse 60" Pot Trellis, With Copper Accents	5
81433	Modern Farmhouse 16" X 18" Fence Panel, With Copper Accents	24
81434	Modern Farmhouse 84" Shepherd Hook, With Copper Accent	5
81435	Modern Farmhouse 14" Hanging Basket	12
81436	Modern Farmhouse 30" Deck & Window Box Planter	6
81437	Modern Farmhouse Wall Planter	4
81438	Modern Farmhouse "Welcome To My Home" Hanging Basket Stand	1
-	Teal Fixture Display With Signage	1
Total number of product pieces on display		61

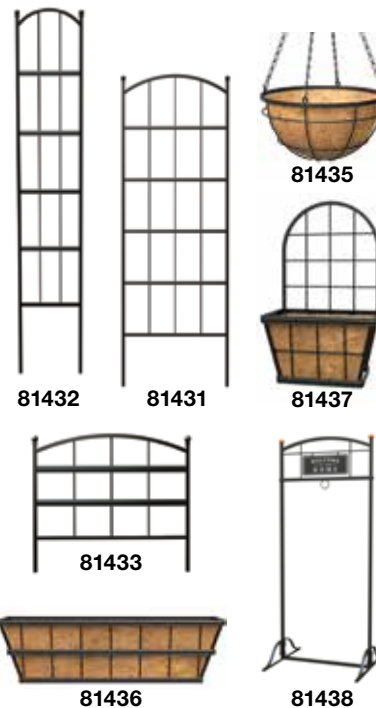

50% Of The Bee Population Is Declining

Bee-Conscious Garden Decor

Garden Decor on a Mission to Educate & Decorate!

Loaded 62-PC Bee-Conscious Shepherd's Hook Display

Item#	Description	Per Case	Cases per display	Total # of pieces
81450	66" Trellis Garden Trellis	5	2	10
81451	36" Trellis Pot Trellis	5	2	10
81452	14" Hanging Basket	6	2	12
81453	72" Double Offset Shepherd Hook	5	2	10
81455	40" Yard Stake Basket Hanger	8	1	8
28554	Honeycomb Modular Mason Bee House with refillable nest tubes, yellow	4	3	12
Total number of product pieces on display				62

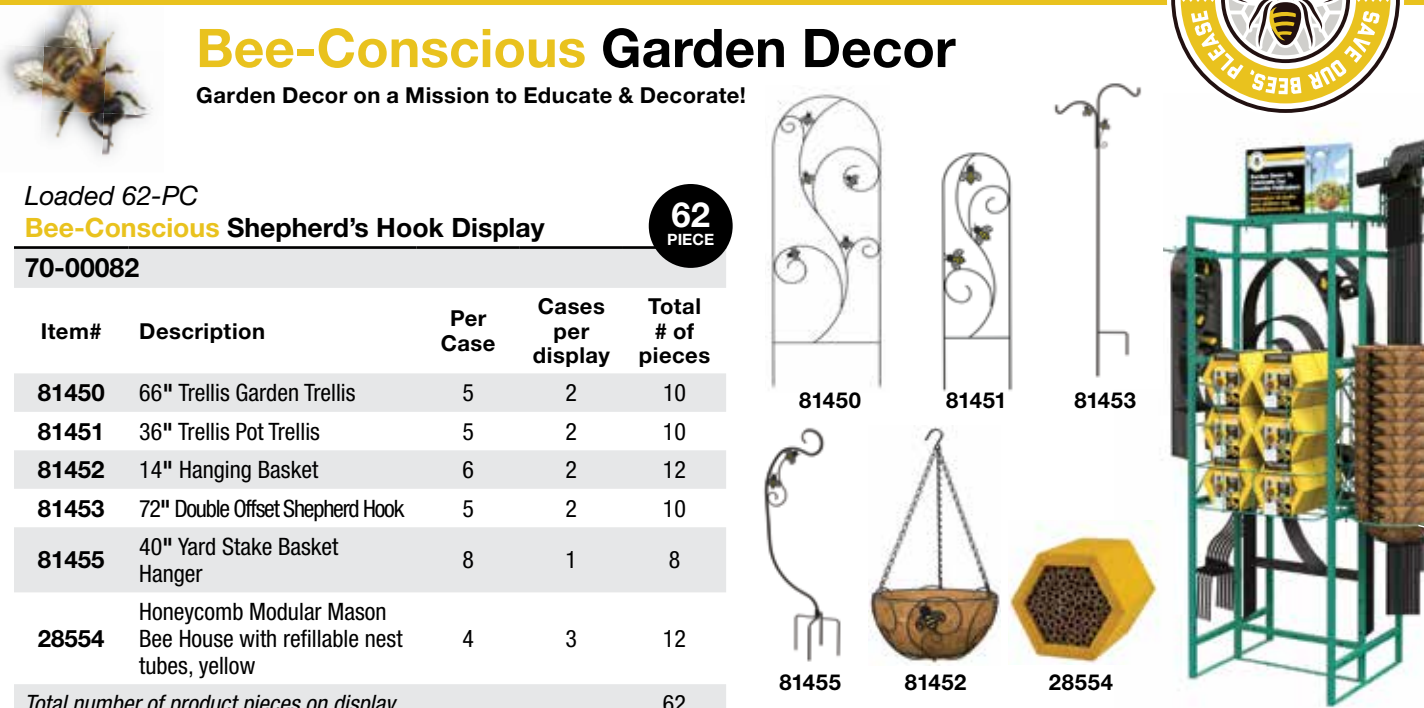

Ask your Panacea representative for our supplemental catalogs with more products



Bird & Nature



Floral



Fireplace



Home Organization



Hookery

PANACEA®

P (614) 850-7000 • F (614) 850-7111
www.PanaceaProducts.com

Urban Gardener®, Modern Farmhouse Home & Garden™, Rustic Farmhouse™, HOLD-ALL®, Olde World Forged™, Birding Basics®, Ultimate Renewable™ Save-Our-Bees-Please™, and WoodLink® are trademarks of the Panacea Products Corporation.

Tom Chambers® is a registered trademark of Tom Chambers Limited.

Audubon® is a licensed and registered trademark of the National Audubon Society.

© Copyright 2022-25 Panacea Products. All Rights Reserved.