



tdibrands™

2023 BUYERS GUIDE



WHO ARE WE?

Since 1996, we've partnered with vendors all over the world to bring you **innovative, distinctive, and timeless garden products**. Our one-of-a-kind approach has provided, and continues to provide, you and your customers with an unmistakable difference in quality, design, and selection.

Our mission from day one still remains true today: to be **your go-to supplier**; the people you turn to for unique garden products. We offer **exclusive brands** that set us apart as your first choice for gardening supplies:

- DeWit Garden Tools
- Tierra Garden Private Label
- SK Pottery
- Little Pals Kids Gardening
- Peacock Plant Supports
- Haxnicks Garden Solutions
- Wagner Plant Caddies
- Birds and Beyond
- TDI Carts & Liners
- Stone Age Creations

Our goal is to spread the joy of gardening across the entire nation while providing **products of the highest quality, world-class service, and creative solutions** for the ever-changing needs of our environments. We want to help grow not only our customers, but also the gardens which our products serve.

Want to learn more? Call us, check us out online, or just ask around. You'll see that we're known for having a broad offering of relevant products, **fast, efficient shipping, high fill rates, great merchandising displays, no hassle warranty replacement, spring dating programs, nationwide distribution and much more.**

Thank you for choosing TDI Brands. As we continue to garden the earth, we look forward to growing with you for many more years to come.

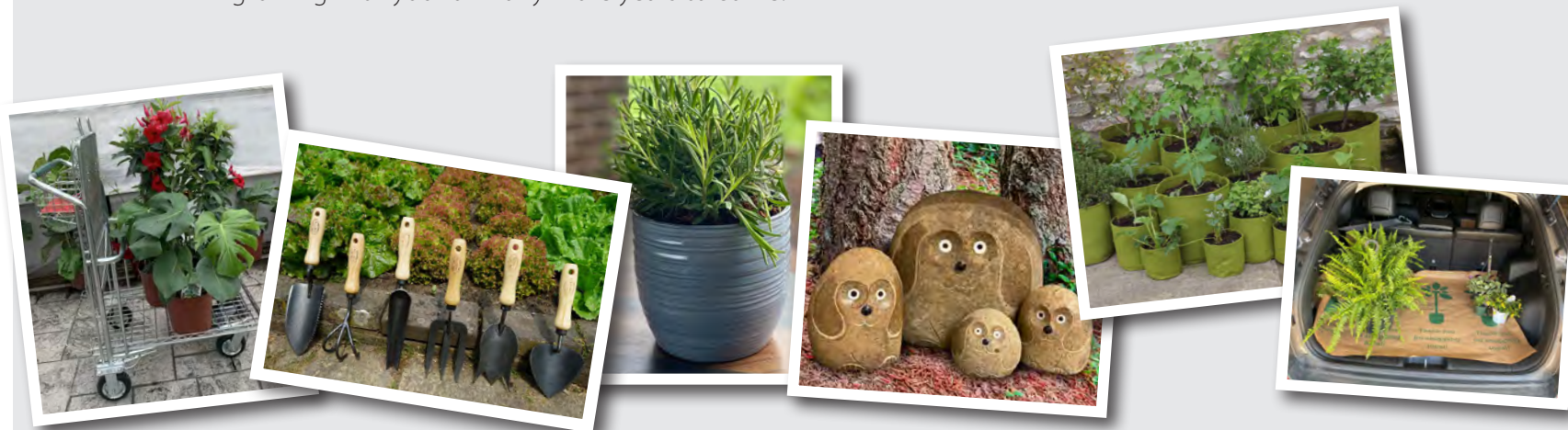

TABLE OF CONTENTS



TERMS & CONDITIONS	2
--------------------	---

GARDEN TOOLS	3
--------------	---

DeWit Garden Tools	Tierra Garden Tools
--------------------	---------------------

SK INDOOR POTTERY	37
-------------------	----

Natural Clay Pottery	Macrame Hangers	Pottery Displays
----------------------	-----------------	------------------

KIDS GARDENING	51
----------------	----

Little Pals Gardening Kits DeWit Junior Tools	Sandbox Eurogarden Tools	Accessories 2-in-1 Picnic Table/Bench
--	-----------------------------	--

PLANT STAKES & SUPPORTS	63
-------------------------	----

Peacock Supports	Garden Stakes
------------------	---------------

GARDENING SOLUTIONS & PLANT PROTECTION	81
--	----

Haxnicks Gardening Garden Arch Plant Stands Kneeling Pads & Mats	Gardening Accessories Self-Watering Trays Greenhouses Plant Halos	Boot Trays Wagon
---	--	---------------------

WATERING CANS	119
---------------	-----

Metal Watering Cans	Aged Zinc Watering Cans	PVC Plastic Watering Cans
---------------------	-------------------------	---------------------------

ORGANIC & HYDROPONIC GARDENING	125
--------------------------------	-----

Composters	Raised Beds	Gardener's Tables
------------	-------------	-------------------

PLANT CADDIES	137
---------------	-----

WPC Caddies Bamboo Caddies	Wood Caddies Metal Caddies	Pot Feet
-------------------------------	-------------------------------	----------

BIRDBATHS	155
-----------	-----

Fiber Clay Birdbaths



SHOPPING CARTS	165
----------------	-----

Choosing the Right Carts Why TDI is Different	Cart Testimonials Carts & Accessories	Technical Specifications
--	--	--------------------------

TERMS & CONDITIONS	186
--------------------	-----

TRUNK LINERS	187
--------------	-----

White Liners Biodegradable Liners	Trunk Liner Stands Polyethylene Tubes	Paper Liners Personalized Liners	Custom Liners
--------------------------------------	--	-------------------------------------	---------------

2023 WHOLESALE CATALOG & PRICING—EFFECTIVE JULY 1, 2022

SPRING DATING PROGRAM AVAILABLE! CALL FOR DETAILS!

MULTIPLE WAYS TO PLACE AN ORDER:

***Minimum order value of \$500** ***Must order in case quantities**

- Contact your local TDI Brands Sales Representative. If you're not sure who that is, we'll be glad to share that information and have your Rep come directly to you.
- Go to www.tierragarden.com, where you can easily create an account and order all of our products online, anytime.
- Send us an email at sales@tdibrands.com with the items you would like.
- If you prefer to chat live, give us a call at 800.992.1220. Our Customer Care Team is ready to assist each weekday from 8:00am to 5:00pm (EST).

PAYMENT & CREDIT TERMS

Standard Payment Terms: Net 30 days (for approved accounts). Credit card payments will be assessed a 3.5% processing fee.

Credit cards accepted:



Credit Terms: To set up an account, call your local TDI Brand Sales Rep. or our Customer Care Team and request a Credit Application. Overdue invoices will be assessed a 1.5% per month finance charge.

RETURNS, DAMAGES, AND WARRANTIES

Returned Goods Policy: Returns are not accepted without prior return authorization from our Customer Care Team. The invoice number must appear on all packages. Return merchandise must be sent freight prepaid along with a copy of the invoice within 30 days of the invoice date. Returns may be subject to a 20% restocking and repackaging fee. Items must be in saleable condition. TDI Brands does not issue call tags.

Shortages and Damages: All claims must be made within 10 days of the invoice date. In the case of a damaged shipment, indicate "damaged" when signing for the package and call us immediately for further instructions. Keep the original carton and damaged merchandise until claim is resolved.

Express Limited Warranty: Tierra-Derco International warrants to the original user and consumer that any goods supplied by Tierra-Derco shall be free from defects in material and workmanship for ONE YEAR from the date of the Garden Center purchase. This EXPRESS LIMITED WARRANTY does NOT apply where there has been a failure of the goods due to misuse, improper assembly, neglect, accident, or normal wear and tear.

Prices and specifications subject to change without notice: We make every attempt to hold catalog prices throughout the year. Due to fluctuations in shipping costs, tariffs, international currency and inflation, price changes may be unavoidable. Actual color of product may vary slightly due to color variations in the catalog printing process. All weights listed in the catalog are approximate. Sizes listed may vary slightly due to handmade craftsmanship.

SHIPMENTS & FREIGHT TERMS

Under normal conditions, in-season orders are shipped within 24 to 48 hours.

In-Season Freight Terms—Eastern/Midwest/Southern US:

- Orders \$500 to \$1,249 will be assessed a 12% of invoice freight charge.
- Orders \$1,250 to \$2,499 will be assessed a 7% of invoice freight charge.
- Orders over \$2,500 will ship Freight Free.
- All freight charges are added to the invoice.
- Invoices are subject to a global surcharge.
- Lift-gate, appointment, ferry, & redelivery charges will be added if required.

In-Season Freight Terms—Western US:

- Western US includes the states of Arizona, California, Idaho, Montana, Nevada, Oregon, Utah, and Washington.
- Orders of \$500+ will be assessed a 17% of invoice freight charge.
- All freight charges are added to the invoice.
- Invoices are subject to a global surcharge.
- Lift-gate, appointment, ferry, & redelivery charges will be added if required.

TIERRA GARDEN'S ELITE DEALER PROGRAM

is more than just a status level or a reason to give you bragging rights. It rewards you with freight savings on every order over \$500, every day throughout the year. To qualify, simply place a "Pre-Season" order of \$2,500 or more of Tierra Garden products from July 1, 2022 to February 28, 2023. Becoming an Elite Dealer can save you a bundle on freight and you can enjoy immediate savings on reorders during the 2022/23 season (July 1, 2022 thru June 30, 2023).

In-Season Elite Freight Terms—Eastern/Midwest/Southern US:

- Orders of \$500 - \$1,249 will be assessed a 7% of invoice freight charge.
- Orders of \$1,250+ will ship **FREIGHT FREE!**
- Invoices are subject to a global surcharge.

In-Season Elite Freight Term—Western US:

- Orders of \$500+ will be assessed a 12% of invoice freight charge.
- Invoices are subject to a global surcharge.

Become an
**ELITE
DEALER**
& Save!

Want to
save even more?
Become A
**PLATINUM
DEALER**

FOB Items: Items marked FOB in our catalog are shipped prepaid with freight charges added to invoice under all programs and circumstances shipped to the continental US 48 states.

Drop Shipments: Tierra Garden is pleased to offer drop ship service directly to your retail customers. A \$4.00 handling fee will be charged per order, plus actual freight. In some cases, extra packaging charges will apply. Give us a call to learn more about our dropship guidelines.

Back Orders: Items temporarily out of stock are shipped at our discretion and according to the freight terms of the original order.

TIERRA
Garden™



GARDENING TOOLS



MORE THAN A TOOL...

THE RIGHT TOOLS
MAKE ALL THE
DIFFERENCE

- Dutch Ash Hardwood Handles
- Lifetime Guarantee*
- Heads Made from High Quality Boron Steel
- A Unique Tool for Every Garden Task
- Hand Forged
- Sustainable, produced with solar energy

* Limited lifetime warranty to original purchaser against manufacturer defects and workmanship.



THE RIGHT TOOL FOR EVERY TASK

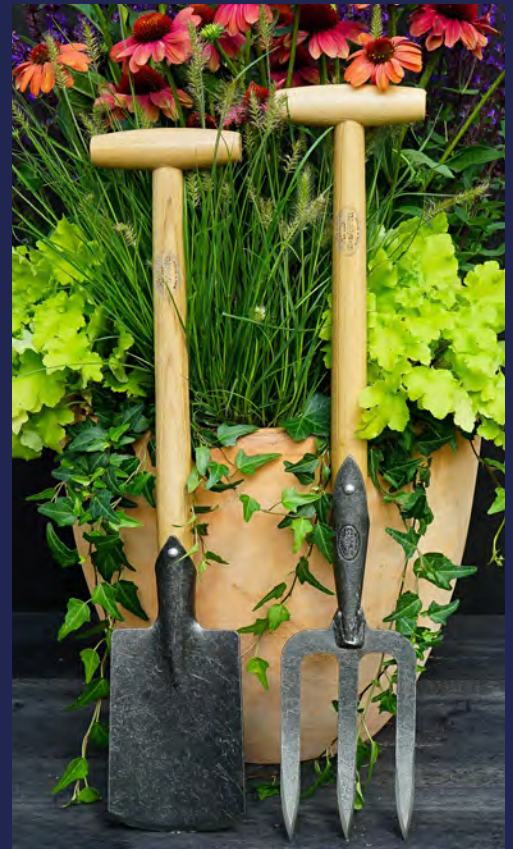

IT'S AN HEIRLOOM.

On April 1, 1898 Willem de Wit started his blacksmith company in Kornhorn, a small village in northern Holland. Today, the 5th generation of the forging family is running the company. Top-notch quality combined with innovative designs make DeWit tools the ultimate gardener's choice. The latest equipment and techniques coupled with historical craftsmanship make DeWit one of the most modern garden tool manufacturers in the world. TDI Brands is proud to be the original DeWit partner.

BEST SELLER



1



2



3

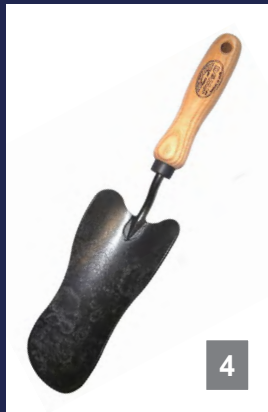

4



5



6



7

1 #31-3000 Trowel

- The Ultimate trowel
- High-quality tempered steel will hold a very sharp edge
- Neither tip nor neck will bend

Head: 6.3"L x 3"W; Total: 12"L; 0.6lbs



8 714936 030001

3 #31-3011 Small Trowel

- Smaller version of our #31-3000
- Designed for smaller hands
- Women's choice!

Head: 5.25"L x 2.6"W; Total: 11.8"L; 0.25lbs



8 714936 030117

5 #31-3001 Medium-Sized Victorian Trowel

- Smaller version of our #31-3003
- Designed for smaller hands
- Women's choice!

Head: 6"L x 3"W; Total: 12.5"L; 0.6lbs



8 714936 030018

2 #31-3008 Bottle Opener Trowel

- High-quality tempered boron steel will hold a very sharp edge
- Neither tip nor neck will bend
- Reward yourself with a beverage after working hard in the garden!

Head: 6.3"L x 3"W; Total: 12"L; 0.6lbs



8 714936 030087

4 #31-3003 Large-Sized Victorian Trowel

- A round-point trowel/scoop with a sharpened edge
- Cuts through roots and clay soil easily

Head: 7.25"L x 3.25"W; Total: 13.5"L; 0.7lbs



8 714936 030032



DUTCH HAND TOOLS

IT'S WELL DONE!

Our strongest and most durable hand tools yet. Flat arm design makes the tool virtually impossible to bend! This modern design makes working in hard soil easy!



See the Welldone Planting Trowel in action!



8



9

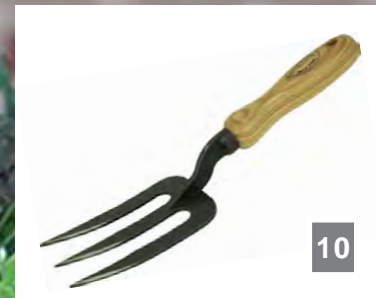

10



11

6 #31-3004 Hand Fork

- Great for breaking up soil in smaller areas; aerates clay soil
- Strong and tough
- Well balanced
- Available in drop grip version (page 20)

Head: 5"L x 3"W; Total: 10.8"L; 0.5lbs



8 714936 030049

8 #31-3346 Welldone Planting Trowel

- The best just got better!
- Flat arm design makes the tool virtually impossible to bend
- Tempered boron steel head holds sharp edge longer than others

Head: 6.3"L x 3.1"W; Total: 13"L; 0.5lbs



8 714936 033460

10 #31-3348 Welldone Hand Fork

- Super strong Welldone design
- Won't bend when digging rock and roots
- Tempered boron steel head is great in tough clay soil

Head: 5.25"L x 3.1"W; Total: 11.4"L; 0.44lbs



8 714936 033484

7 #31-3015 Small Hand Fork

- Smaller version of our #31-3004
- Designed for smaller hands
- Women's choice!

Head: 4"L x 2.6"W; Total: 10"L; 0.25lbs



8 714936 030155

9 #31-3344 Welldone Serrated Trowel

- Our #31-3346 trowel with a serrated edge on the left side
- Use to cut roots, dead perennials, and stubborn vines and weeds
- Combines the benefits of Hori-Hori knife and a trowel

Head: 6.3"L x 2.4"W; Total: 13.4"L; 0.5lbs



8 714936 033446

11 #31-2950 Welldone American Mini Shovel

- Virtually impossible to bend
- Perfect for removing rocks and roots
- Tempered boron steel head easily cuts through tough clay soil
- Available in drop grip and long handle versions (page 21 & 24)

Head: 5.5"L x 4.1"W; Total: 13.25"L; 0.66 lbs



8 714936 029500

A TOOL FOR EVERY TASK

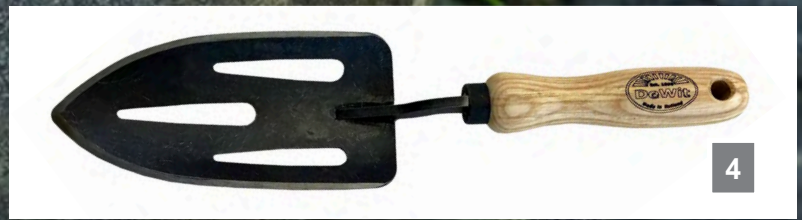
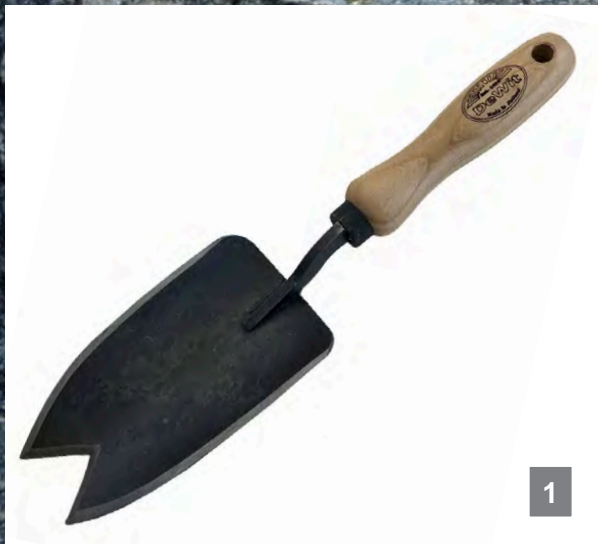

1 #31-3028 Two Point Large Trowel

- V-cut edge makes digging, dividing and planting in heavily rooted areas easier
- Edge is razor-sharp and cuts easily through roots and clay soil
- Extra strong “Welldone” design makes it one of the strongest trowels in the world

Head: 5.5”L x 3.1”W; Total: 12.2”L; 0.5lbs



3 #31-3029 Square Head Trowel

- Flat, razor-sharp edge cuts through the toughest soil
- Designed to dig holes and remove soil with ease
- Extra strong “Welldone” design makes it one of the strongest trowels in the world

Head: 5.6”L x 3.1”W; Total: 12.2”L; 0.5lbs



2 #31-3027 Two Point Small Trowel

- V-cut edge makes digging, dividing and planting in heavily rooted areas easier
- Edge is razor-sharp and cuts easily through roots and clay soil
- Head and neck are hand forged creating a strong connection

Head: 4.5”L x 2.5”W; Total: 11.2”L; 0.4lbs



4 #31-3337 Sieve Trowel

- Ergonomically designed with slots cut in blade to create a lighter tool and reduce friction
- Allows for easier mixing of soil and additives and removing larger rocks from soil
- Extra strong “Welldone” design makes it one of the strongest trowels in the world

Head: 6.3”L x 3.1”W; Total: 13”L; 0.5bs



QUALITY TOOLS MAKE TOUGH TASKS EASIER



5 **#31-3147 Bent Tine Fork**

- Bent tines allow this fork to be used as a rake or cultivator
- Perfect for those tight, hard to reach spaces
- Reinforced “Welldone” design makes it super strong

Head: 3.4”L x 3.1”W; Total: 10.6”L; 0.4lbs



8 714936 031473

6 **#31-3990 Twisted Tine Hand Fork**

- Each tapered tine is twisted to give the tool added strength
- The tapered tines make the tool much easier to work with
- Ideal for digging through tough clay soil, mixing topsoil and plant removal
- Reinforced “Welldone” design makes it super strong

Head: 5.3”L x 3.1”W; Total: 11.8”L; 0.4lbs



8 714936 039905

7 **#31-3940 Comby Cultivator**

- Two complementary tools in one
- Cultivator and stirrup hoe combination
- Simply turn the tool to use the preferred edge
- Also available in drop grip and long handle versions (page 21 & 27)

Head: 4.5”L x 3.7”W; Total: 11.6”L; 0.5lbs



8 714936 039400



See our DeWit products in action

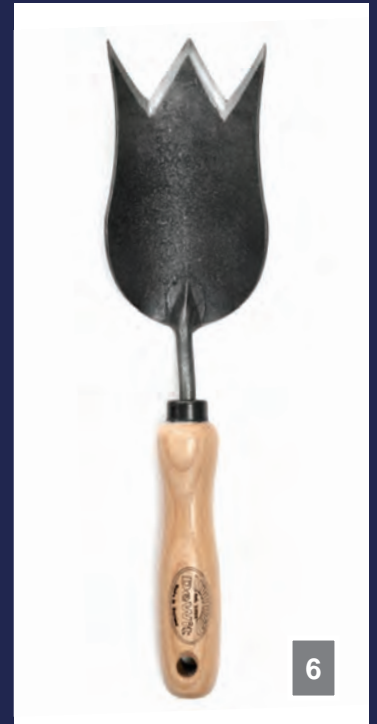
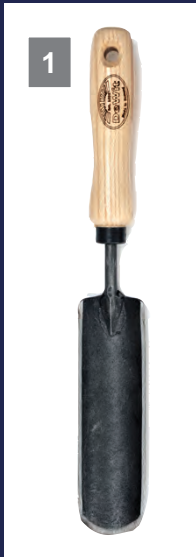

1 #31-3032 Rock-N-Root Trowel

- Heavy-Duty, 3mm thick blade
- Narrower than Transplant Trowel
- Deep digging in confined spaces

Head: 5" L x 1.75"W; Total: 16"L; 0.5lbs



8 714936 030322

3 #31-2941 Scoop Trowel

- Heavy duty
- Extra large head
- Use as a scoop or trowel
- Forged steel

Head: 7.75" x 4.74"W; Total: 13.8"L; 0.7lbs



8 714936 029418

5 #31-3661 Ninja Onion Hoe

- Strong, sleek, all steel tool
- Compact & lightweight for precision
- Onion hoe on one side, dandelion weeder on the other

10"L x 1.75"W; 0.3lbs



8 714936 036614

2 #31-3002 Transplant Trowel

- Narrow blade is perfect for working in tight spots
- Ideal for planting bulbs and other precise tasks

Head: 7"L x 2.25"W; Total: 13.5"L; 0.5lbs



8 714936 030025

4 #31-3660 Ninja Cultivator

- Strong, sleek, all steel tool
- Compact & lightweight for precision
- 3-Tine Cultivator on one side, cobra-shaped head on the other

9.45"L x 1.75"W; 0.3lbs



8 714936 036607

6 #31-3034 Tulip Trowel

- Works like a trowel, but breaks up soil like a fork - great for clay!
- Three sharp points to break up soil quickly and easily
- Also in 16" or 32" T-grip handles (page 22)

Head: 4.5"L x 4"W; Total: 11"L; 0.5lbs



8 714936 030346



7



8



See this tool in action!



9



10

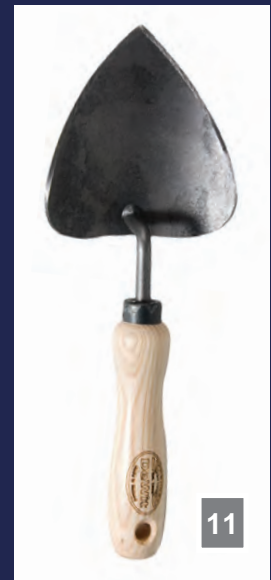

11

7 #31-3047 British Style Bulb Planter

- Sharp cutting edge slices thru soil
- Lead edge is narrower in diameter than rest of cylinder allowing soil plug to fall out easily

Head: 5.7"L x 2.75"W; Total: 10.5"L; 1.4lbs



9 #31-3087 Wooden Dibber w/Brass Tip

- Use to plant bulbs and seeds
- Push brass tip into the soil and swirl it around to the size needed
- Wooden shaft is marked to achieve a more precise depth every time - perfect for garlic!

12"L x 1.5"W; 0.3lbs



11 #31-0906 Potting Trowel

- Curved blade prevents soil from spilling out
- The wider and shorter blade makes it perfect for potting plants

Head: 4.5"L x 4"W ; Total: 11"L; 0.5lbs



8 #31-0909 Bulb Planter

- The ultimate tool for small bulbs
- Perfect for crocuses, snowdrops, grape hyacinths
- Easy to use and clean
- Long handle on page 30

Head: 4"L x 1.5"W; Total: 10.5"L; 0.5lbs



10 #31-3005 Snake Tongue Trowel

- Works like a transplanter trowel and a weedpopper all in one
- Hand-Forged steel
- Easy to use

Head: 7"L x 1.8"W; Total: 12.5"L; 0.6lbs





1 #31-0303 Triangle Patio Knife

- 3 V-shaped weeding blades
- 2 wide and 1 narrow for different shaped bevels on pavers
- Available in 55" handle (page 27)

Head: 2"L x 1.75"W; Total: 9.5"L; 0.3lbs



3 #31-0914 V-Groove Paver Cleaner

- Easily clean out between pavers
- Two different shaped V's for different size beveled edges
- Available in 51" handle (page 27)

Head: 4"L x 0.5"W; Total: 9.5"L; 0.5lbs



5 #31-0904 Short Handle 3-Tine Cultivator

- Perfect tool for quick aerating jobs
- Great for hard-to-reach places
- Also available with a 51" handle (page 25)

Head: 3"L x 3"W; Total: 11.5"L; 0.5lbs



2 #31-0910 Patio Knife

- Removes weeds between pavers
- Use hook side for joints and knife side for beveled edges
- Available in 51" handle (page 27)

Head: 5.5"L x 3"W; Total: 10"L; 0.5lbs



4 #31-0907 Disc Weeder

- 4-in-1 tool
- Weeder, knife, edger, and digger
- Small, yet crafted to yield strength
- Also in 37" or 62" handles (page 27)

Head: 2.75"D; Total: 11"L; 0.5lbs



6 #31-0903 Short Handle 5-Tine Cultivator

- Great for cultivating tough soil
- Aggressive, sharp, and strong
- Makes working in tight spaces a breeze

Head: 3.5"L x 3.5"W; Total: 11"L; 0.5lbs





NO MORE WEEDS!

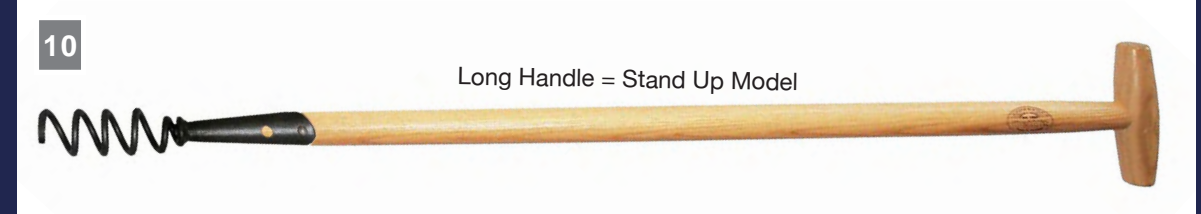

7 #31-3098 Short Handle 2-Prong Weeding Fork

- Used to extract deep taproots
- Known as a “jekyll” weeder
- Allows you to loosen soil around the root and then pry it from the soil

Head: 6”L x 1.6”W; Total: 11.3”L; 0.45lbs



#31-0806 and #31-0805 Cork Screw Weeders

- Simple weeder removes entire root
- Screw into soil and pull to remove
- Great for dandelions
- Also works as a compost aerator!

10 #31-0806 Long Handle

Head: 5”L x 1.5”W;
Total: 40”L; 2.5lbs



13 #31-0905 Dandelion Weeder

- Traditionally used as an asparagus cutter
- Great for popping up weeds, especially dandelions

Head: 8.5”L 0.6”W; Total: 14”L; 0.5lbs



8 #31-3055 Spring Tine Cultivator

- Great for cultivating soil with rocks
- Also known as a “scratch” cultivator

Head: 5”L x 3”W; Total: 12”L; 0.5lbs



11 #31-0805 Short Handle

Head: 5”L x 1.5”W;
Total: 22”L; 1.5lbs



14 #31-0925 Garden Knife

- Versatile, multi-purpose tool
- Cuts weeds and roots, and digs out small rocks
- Bulb planter or mini trowel

Head: 4”L x 1”W; Total: 8”L; 0.5lbs



9 #31-3043 Hand Claw

- Dig, weed, and cultivate with one tool

Head: 5”L x 3.25”W; Total: 9.9”L; 0.5lbs



12 #31-3482 Weedpopper

- Dandelion weeder with rocker arm
- Rocker gives leverage to easily pop up weeds

Head: 6.8”; Total: 11.8”L x 2.0”W; 0.5lbs





**1 #31-0915
Right Hand Cape Cod Weeder**

- Slice weeds off at the base
- Drag under mulch to get rid of weeds without disturbing mulch
- One of our most popular tools!

Head: 3"L x 1.75"W; Total: 10.5"L; 0.5lbs



**3 #F10
Right Hand Dutch Hand Hoe**

- Small, yet crafted to yield tremendous strength; balance provides control
- Hand-forged blade is easily sharpened with whetstone

Head: 2"L x 4.5"W; Total: 18"L; 0.62lbs



**5 #31-2901
Right Hand Japanese Hand Hoe**

- Double-sided blade
- Excellent for removing grass/weeds
- Great for weeding under mulch
- Larger blade than Cape Cod Weeder

Head: 7"L x 4.25"W; Total: 13"L; 0.5lbs



**2 #31-0916
Left Hand Cape Cod Weeder**

- Slice weeds off at the base
- Drag under mulch to get rid of weeds without disturbing mulch
- One of our most popular tools!

Head: 3"L x 1.75"W; Total: 10.5"L; 0.5lbs



**4 #F11
Left Hand Dutch Hand Hoe**

- Small, yet crafted to yield tremendous strength; balance provides control
- Hand-forged blade is easily sharpened with whetstone

Head: 2"L x 4.5"W; Total: 18"L; 0.62lbs



**6 #31-2902
Left Hand Japanese Hand Hoe**

- Double-sided blade
- Excellent for removing grass/weeds
- Great for weeding under mulch
- Larger blade than Cape Cod Weeder

Head: 7"L x 4.25"W; Total: 13"L; 0.5lbs



DEWIT BONSAI TOOL KIT

Perfect for maintaining terrariums and miniature gardens and transplanting seedlings



9



10



12

13



11



7

#31-2906 Right Hand Korean Hand Hoe

- Also known as the "Ho-Mi"
- Great for digging and cultivating
- Works well for setting bulbs
- Blade is shaped like a plow

Head: 6"L x 3"W; Total: 12"L; 0.65lbs



8 714936 029067

8

#31-2907 Left Hand Korean Hand Hoe

- Also known as the "Ho-Mi"
- Great for digging and cultivating
- Works well for setting bulbs
- Blade is shaped like a plow

Head: 6"L x 3"W; Total: 12"L; 0.65lbs



8 714936 029074

9

#31-0929 Heart Shaped Hoe

- A smaller version of the long-handled Heart Shaped Push Hoe
- Push underneath mulch or soil to remove weeds

Head: 2.75"L x 3.5"W; Total: 13.5"L; 0.5lbs



8 714936 034443

10

#31-0930 Onion Hoe

- A chopping hoe
- Extended handle offers extra reach when weeding gardens and beds

Head: 1.5"L x 4"W; Total: 14"L; 0.5lbs



8 714936 034467

11

#31-3478 Bonsai Tools

- These precision tools are great for Bonsai Gardens
- Use to transplant tiny seedlings
- Set stores in wooden box

6" - 7"L x 1.5"W x 1"H; 1.6lbs



8 714936 034788

12

#31-3470 (sold separately) Bonsai Trowel

- Perfect for houseplants

Head: 3"L x 1"W; Total: 7"L; 0.25lbs



8 714936 034702

13

#31-3471 (sold separately) Bonsai Fork

- Perfect for houseplants

Head: 3"L x 1"W; Total: 6.5"L; 0.25lbs



8 714936 034719



1



2

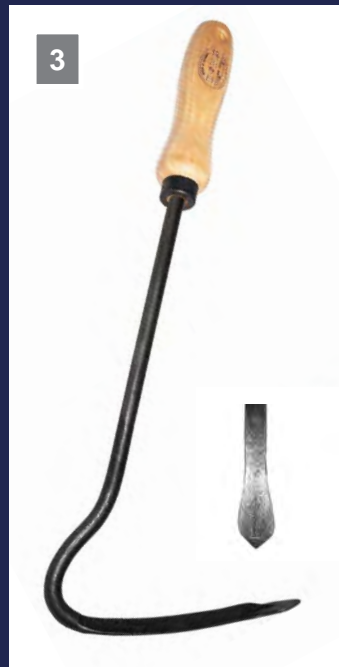

3



4



1 #31-3031 Serrated Farmer's Dagger

- Compared to Hori Hori knife
- 5mm thick boron steel blade
- Serrated edge
- Heavy duty garden knife

Head: 6.5"L x 1.5"W; Total: 16"L; 0.85lbs



8 714936 030315

3 #31-3067 Cobra-Style Cultivator

- Weeds and cultivates planting beds
- Used to plant seeds
- Great for breaking up hard soil
- Provides precision weeding

15.7"L x 7.1"W x 1"H; 0.34lbs



8 714936 030674

5 #31-3451 Bio 3-Tine Cultivator

- Perfect tool for quick aerating jobs
- Works great for hard-to-reach places

Head: 2.5"W; Total: 12.5"L; 0.35lbs



8 714936 034511

2 #31-3338 Branch Hook

- The helping hand in your garden and landscaping
- Just pull it towards you to trim out-of-reach branches
- Helps easily harvest fruit

Head: 4.3"L x 3.5"W; Total: 34"L; 0.77lbs



8 714936 033385

4 #31-1110 Dutch Transplanter

- Extra long narrow blade makes transplanting a breeze
- Digs out deep roots
- Works great in rock gardens

Head: 8"L x 1"W; Total: 15.5"L; 0.5lbs



8 714936 030391



DeWit Bio Tools

Bio Tools are made from a single piece of boron steel, that is cut on a laser machine, heated by induction, pressed and hardened.

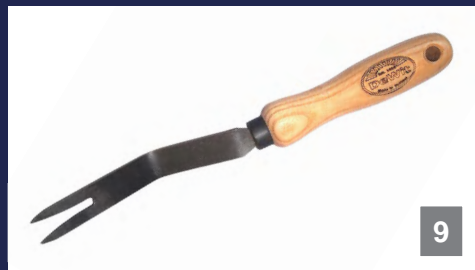

6 #31-3453
Bio V-Groove Weeder

- Easily clean out between pavers and other narrow spaces
- Cobra-shaped head
- Great for hard-to-reach spaces

Head: 0.6"W; Total: 11.9"L; 0.3lbs



8 #31-3450
Bio Onion Hoe

- A lightweight chopping hoe
- Sharpened blade tears up soil
- Pull to rid weeds under surface
- Great for hard-to-reach spaces

Head: 3"W; Total: 12.5"L; 0.4lbs



10 #31-3452
Bio Soil Aerator

- Perfect tool for quick aerating jobs
- Works great for hard-to-reach places
- Helps break up hard soil

Head: 0.8"W; Total: 12.5"L; 0.35lbs



7 #31-3454
Bio Daisy Grubber

- Traditionally used as an asparagus cutter
- Great for popping up weeds, especially dandelions

Head: 7.5"W; Total: 13"L; 0.5lbs



9 #31-3456
Bio Weed Fork

- Simple rocker arm design adds leverage to easily pop out stubborn weeds
- Great for dandelions and wild onions

Head: 1.8"W x 3.1"D; Total: 11.4"L; 0.3lbs



11 #31-3457
Bio Hand Rake

- Perfect for cultivating tough soil
- Works well in tight spaces and raised bed gardening
- Lightweight rake

Head: 3"W x 3.5"D; Total: 13.5"L; 0.4lbs



PUSH OR PULL... IT'S PERFECT!

"THE P-GRIP"

- Use one or two hands
- Push or pull
- Great for seniors
- Ergonomic shape
- Strong ash handles
- Perfect for raised bed gardening

Developed by TDI Brands and manufactured by DeWit, this exclusive P-Grip handle is much more ergonomic than a standard hand tool. The "P" handle allows the use of either one or two hands while giving more pushing and pulling power with less pain!

The P-Grip's appeal to the aging population and "no frills" ergonomics, along with the natural look and feel of the tool, creates much interest for this innovative design.



1 #31-8510 P-Grip Trowel

- Ultimate trowel with P-Grip handle
- Easier to dig holes for planting
- Put stress on tool, not wrists/shoulders

Head: 6.25"L x 3.5"W; Total: 18"L; 0.7lbs



8 714936 085100

2 #31-8511 P-Grip Transplant Trowel

- Narrow blade is perfect for working in tight spots
- Put stress on tool, not wrists/shoulders

Head: 7"L x 2.5"W; Total: 18.5"L; 0.6lbs



8 714936 085117

3 #31-8516 P-Grip Right Hand Cape Cod Weeder

- Slice weeds off at the base
- Drag under mulch to get rid of weeds without disturbing mulch
- A very popular tool!

Head: 3"L x 1.75"W; Total: 16"L; 0.5lbs



8 714936 085162

4 #31-8517 P-Grip Left Hand Cape Cod Weeder

- Slice weeds off at the base
- Drag under mulch to get rid of weeds without disturbing mulch
- A very popular tool!

Head: 3"L x 1.75"W; Total: 16"L; 0.5lbs



8 714936 085179

5 #31-8506 P-Grip 5-Tine Cultivator

- Great for hard-to-reach, small areas
- Put stress on tool, not wrists/shoulders

Head: 4"L x 4.5"W; Total: 16.5"L; 0.6lbs



8 714936 085063

6 #31-8508 P-Grip 3-Tine Cultivator

- Perfect for quick aerating jobs
- Put stress on tool, not wrists/shoulders

Head: 4"L x 3.5"W; Total: 16.5"L; 0.5lbs



8 714936 085087

7 #31-8507 P-Grip Reinforced Planting Trowel

- Designed for people with arthritis
- Put stress on tool, not wrists/shoulders

Head: 7"L x 3.14"W; Total: 18.5"L; 0.75lbs



8 714936 085070

DEWIT GIFT SETS

The perfect gift for pros or beginners that will last a lifetime!

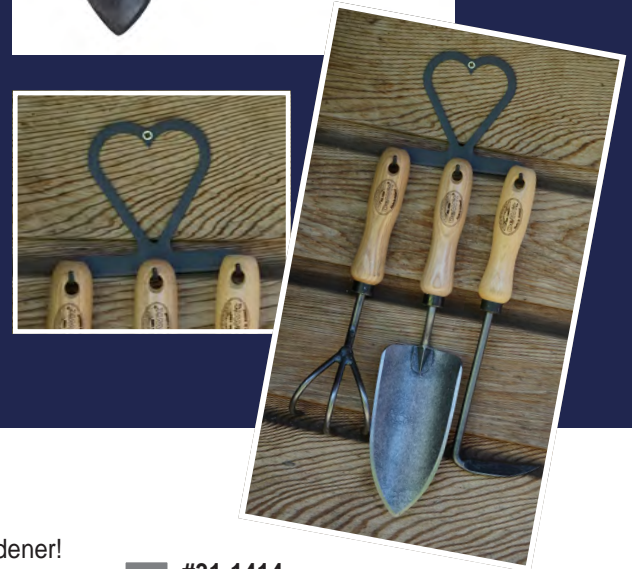
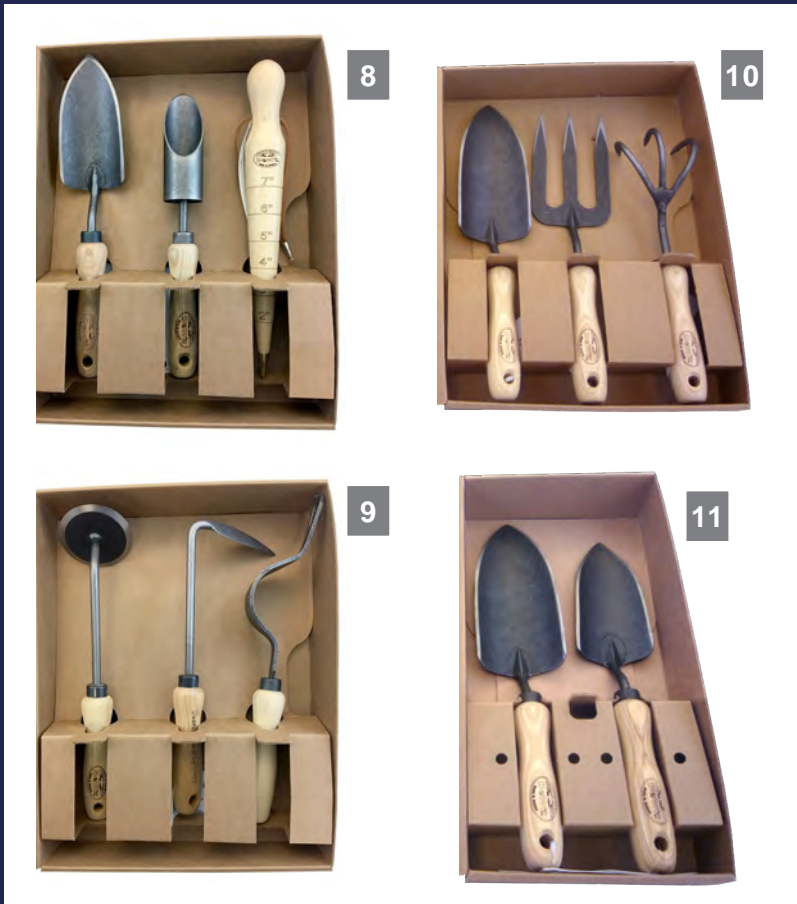

8 #31-3336
3-Piece Bulb Planting Gift Set

- Includes #31-3011 Small Forged Trowel, #31-0909 Amaryllis Bulb Planter, 31-3087 Wooden Dibber

Package: 13.75"L x 7"W x 2.75"H; 1.5lbs



10 #31-3333
3-Piece Tool Gift Set

- The perfect gift for any gardener!
- Includes #31-3000 Forged Trowel, #31-3004 Forged Fork, and #31-0904 3-Tine Cultivator

Package: 13.75"L x 10.5"W x 2.75"H; 2.1lbs



9 #31-3335
3-Piece Weeding Gift Set

- Includes #31-0907 Disc Weeder, 31-0915 Right Hand Cape Cod Weeder, 31-3482 Weedpopper
- The perfect weeding combination!

Package: 13.75"L x 7"W x 2.75"H; 1.5lbs



11 #31-3334
2-Piece Tool Gift Set

- Use larger trowel for larger area and the small trowel in tight spaces
- Includes #31-3000 Forged Trowel and #31-3011 Forged Small Trowel
- Great for couples!

Package: 13.75"L x 7"W x 2.75"H; 1.5lbs



12 #31-1414
3-Piece Tool Set with Hanger

- Set consists of Forged Trowel, 3-Tine Cultivator and Right Hand Cape Cod Weeder
- Comes with convenient and decorative holder
- Makes the perfect gift

Package: 14"L x 5"W x 4"H; 1.5lbs



DROP GRIP TOOLS

The bulb on both ends of the handle keeps your hands from slipping off the handle.

Made from Ash, the tools measure around two feet in length. Great for working in raised beds and to use along with a kneeler seat. And a great two-hand tool for seniors!



1 #31-8713 Drop Grip Trowel

- The ultimate trowel with Drop Grip
- Easier to dig holes for planting
- Hand forged steel
- Available in short and long handle versions (pages 6 & 18)

Head: 6.3"L x 3"W; Total: 26"L; 0.8lbs



8 714936 087135

3 #31-8761 Drop Grip Fork

- Great for working soil in smaller areas
- Use to aerate soil
- Handle provides more leverage
- Available in short handle version (page 6)

Head: 5"L x 3"W; Total: 26"L; 0.8lbs



8 714936 087616

5 #31-8736 Drop Grip 5-Tine Hand Rake

- Great for working soil in smaller areas
- Use to weed and aerate
- Handle provides more leverage

Head: 2"L x 3.5"W; Total: 24"L; 0.7lbs



8 714936 087364

2 #31-8755 Drop Grip Daisy Grubber

- Offers leverage to remove entire root
- Place dandelion in between prongs and pry out of soil
- Easy and quick to use

Head: 1.5"W; Total: 26.5"L; 1.1lbs



8 714936 087555

4 #31-8725 Drop Grip 3-Tine Cultivator

- Perfect tool for quick aerating jobs
- Works great in hard-to-reach places
- Use in raised bed gardening
- Available in short and long handle versions (pages 12 & 18)

Head: 3"L x 3"W; Total: 24"L; 0.65lbs



8 714936 087258

6 #31-8707 Drop Grip Onion Hoe

- Offers extra reach when weeding gardens and flower beds
- Pull to rid weeds under surface
- Available in short handle version (page 15)

Head: 3.7"W; Total: 23.4"L; 0.6lbs



8 714936 087074



See how easy sowing rows can be with the Drop Grip Hand Plow!



7 #31-8737 Drop Grip Right Hand Cape Cod Weeder

- Slice weeds off at the base
- Drag under mulch to get rid of weeds without disturbing the mulch
- Handle provides more leverage
- Available in short and long handle versions (pages 14 & 18)

Head: 3"L x 1.75"W; Total: 26"L; 0.8lbs



8 714936 087371

8 #31-8740 Drop Grip Left Hand Cape Cod Weeder

- Slice weeds off at the base
- Drag under mulch to get rid of weeds without disturbing the mulch
- Handle provides more leverage
- Available in short and long handle versions (pages 14 & 18)

Head: 3"L x 1.75"W; Total: 26"L; 0.8lbs



8 714936 087401

9 #31-2916 Drop Grip Hand Plow

- A handy mini-furrow opener for planting seeds
- Great for use in raised beds
- Cultivate and break up soil

Head: 5"L x 6.3"W; Total: 22.4"L; 0.9lbs



8 714936 029166

10 #31-3941 Drop Grip Comby Cultivator

- A cultivator and hoe in one!
- Cultivate tough soil with one side
- Cut weeds off at the roots with the other
- Available in short and long handle versions (pages 9 & 27)

Head: 4.5"L x 4"W; Total: 24"L; 0.7lbs



8 714936 039417

11 #31-2951 Drop Grip American Style Mini Shovel

- Super strong Welldone design with a mini-step for added foot power
- Easily dig holes for planting
- Available in short and long handle versions (pages 6 & 24)

Head: 5.5"L x 4.1"W; Total: 26.5"L; 1lbs



8 714936 029517

12 #31-3062 Drop Grip Thistle Weeder

- Original DeWit design made to easily remove thistle weeds
- Added tube works as a lever to pull the weed up

Head: 4.5"L x 4"W; Total: 24"L; 0.7lbs



8 714936 030629



SEE THE
PERENNIAL SPADE
IN ACTION!

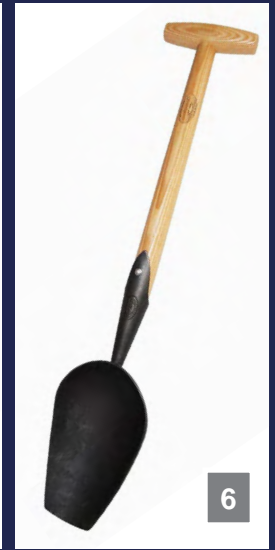
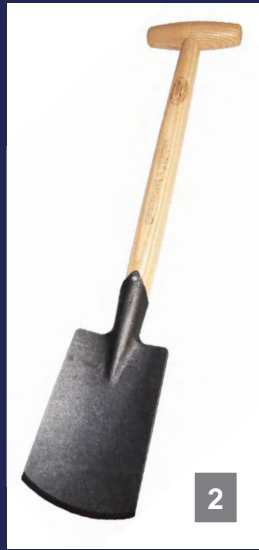

1 #31-3192 and #31-3193 Tulip Spades w/T-Handle

- Our Tulip Trowel head now comes in longer T-handle versions
- Tulip is part spade, part fork
- Three sharp points break up soil quickly and easily
- Available in short handle (page 7)

#31-3192 Tulip Spade Long Handle
Head: 6.7"L x 4.7"W; Total: 38.6"L; 1.8lbs



#31-3193 Tulip Spade Medium Handle
Head: 6.7"L x 4.7"W; Total: 22.6"L; 1.4lbs



2 #31-0926 and #31-0919 Perennial Spades w/T-Handle

- Small handle and head make it easier to plant in a small area
- Long handle allows you to stand instead of kneel
- Easily slice through soil

#31-0919 Perennial Spade Medium Handle Head: 6.5"L x 4.5"W; Total: 22"L; 2lbs



#31-0926 Perennial Spade Long Handle Head: 6.9"L x 4.5"W; Total: 38"L; 1.5lbs



3 #F20 Perennial Planter w/T-Handle

- Most versatile two-handed tool for planting and dividing perennials
 - Sold by bulb companies for decades
- Head: 5"L x 4.5"W; Total: 21"L; 1lb



#F30 and #31-0927 Perennial Forks w/T-Handle

- Dig and divide bulbs without damage
- Long handle allows you to stand instead of kneel
- Lightweight yet durable

4 #F30 Fork Medium Handle
Head: 5"L x 3.5"W; Total: 23"L; 1.5lbs



5 #31-0927 Fork Long Handle
Head: 6.7"L x 4.3"W; Total: 40.2"L; 1.5lbs



6 #31-2942 Compost Digging Scoop w/T-Handle

- Thick blade with sharp front edge, great for planting and scooping
 - Great for raised bed gardening!
- Head: 8"L x 4.5"W; Total: 25"L; 1.5lbs





DUTCH SPORKS

Spork blades are made from boron steel. The design features slots in the blade to give the tool a spring effect. The blade will not bend, even with heavy-duty use. The unique cutting edge of the Spork tool makes it easy to cut through the soil or lawn.

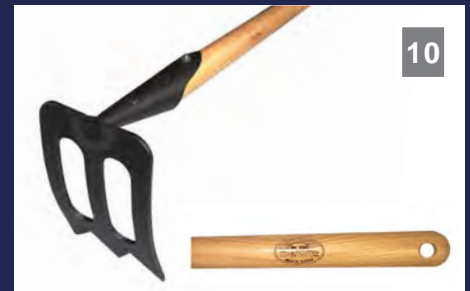

6 #31-0810 Mini Spork w/T-Handle

- Ideal for tilling and breaking up soil
- Sharp edges easily penetrate soil
- Open slots allow spork to slide in and out of soil

Head: 6"L x 4.5"W; Total: 39.5"L; 1.75lbs



8 #31-0815 Perennial Spork w/T-Handle

- Ideal tool for digging in small, confined areas
- Works great for splitting large perennials for transplanting

Head: 6"L x 4.5"W; Total: 25"L; 1.5lbs



7 #31-8305 Solid Socket Spork w/T-Handle

- Combines the features of a spade and fork; patented design
- Ventilated head slides through the soil with less friction
- Featured on Hallmark Home & Family

Head: 9.5"L x 6"W; Total: 46"L; 3.5lbs



9 #31-0816 Hand Spork

- Multi-tasking hand tool
- Combines trowel, fork, and hoe
- Digs soil like a trowel, cultivates like a fork, and hoes w/sharp blade

Head 4.5"L x 3.25"W; Total: 12"L; 0.5lbs



10 #31-0811 Pull Spork

- Perfect tool for tilling and breaking up soil
- Pull to break up soil instead of pushing

Head: 4.5"L x 3.25"W; Total: 62"L; 1.5lbs





THE ULTIMATE FORGED SPADES & FORKS

All DeWit spades and forks feature the T-handle design to ease stress on the hand and wrist.



1 #31-5547 Dutch Digging Fork

- Extremely sharp and sturdy
- Great for digging and working up gardens and flower beds
- Easily slides into soil with little effort

Head: 11"L x 7.25"W; Total: 48"L; 4lbs



3 #31-2051 Solid Socket Digging Spade

- One-piece, forged steel head
- Sharpened blade to slice through soil easier
- An heirloom tool

Head: 10.5"L x 6"W; Total: 45"L; 4lbs



5 #31-2952 American Style Mini Shovel

- Super strong Welldone design
- Great for working in hard soil
- Makes an ideal bulb planter
- Has a mini step for added foot power
- Available in short and dropgrip versions (pages 7 & 21)

Head: 5.5"L x 4.1"W; Total: 37.5"L; 1.4lbs



2 #31-2052 Solid Socket Transplant Spade

- One-piece, forged steel head
- Ultimate spade for transplanting trees and shrubs
- An heirloom tool

Head: 12.75"L x 5"W; Total: 47"L; 3.5lbs



4 #31-8308 Forged Shark Tooth Spade

- Pronounced sharp teeth on this spade attack any tough digging chore
- Great for breaking up clay & cutting roots
- One-piece forged steel head is extra strong and allows teeth to stay sharp longer

Head: 9.4"L x 6.3"W; Total: 44"L; 4.4lbs



TDI Brands Channel

LONG HANDLE TOOLS

Stand up straight and tall while weeding with the push/pull motion of the Diamond Hoe - a best-seller! Save your knees with the Long Handle 3-Tine Cultivator and work standing up!

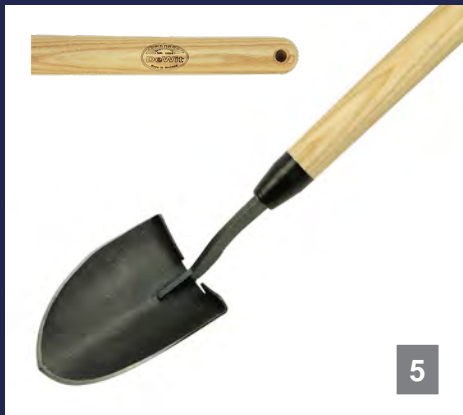

6 #31-10
Diamond Hoe Straight Handle

- Features 4 very sharp forged edges
- Designed to push and pull while cutting weeds just below surface
- No chopping needed!

Head: 2"L x 8"W; Total: 61"L; 3lbs



8 714936 439200

8 #31-0941
3-Tine Cultivator Long Handle

- Perfect tool for quick aerating jobs
- Great for hard-to-reach places
- Work standing up versus hunched over
- Also available in hand tool (page 12)

Head: 3"L x 3"W; Total: 61"L; 1.7lbs



8 714936 030544

9 #31-3978
Oscillating Hoe with P Grip

- Blade is made of Boron Steel
- Handle is 56" long
- Lifetime guarantee

Head: 11"L x 7"W; Total: 63"L; 2.9lbs



8 714936 030544

7 #D20
Diamond Hoe P-Grip

- Features 4 very sharp forged edges
- Designed to push and pull while cutting weeds just below surface
- No chopping needed!

Head: 2"L x 8"W; Total: 74"L; 3.5lbs



8 714936 939205



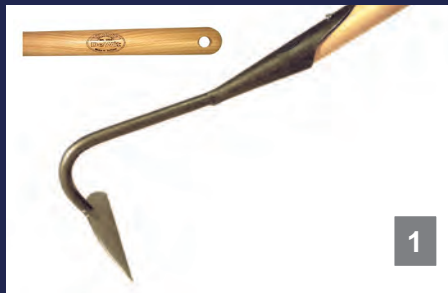

1 #31-20 and #D10 Half Moon Pull Hoes

- Our Half Moon pull hoe is an old traditional Dutch hoe
- Designed for cutting weeds and cultivating just below the surface
- The very sharp, forged edges make it possible to easily pull weeds at the soil surface

#31-20 Half Moon Pull Hoe Standard 62" Handle

Head: 2"L x 6.25"W; Total: 63"L; 3lbs



8 714936 435165

#D10 Half Moon Pull Hoe with Long 72" Handle

Head: 2"L x 6.25"W; Total: 75"L; 3.5lbs



8 714936 935160

2 #31-3016 Push Hoe

- Forged V-shaped head
- The original Dutch push hoe
- Sharpened and hardened Boron steel - heavy-duty and durable

Head: 2.25"L x 6.25"W; Total: 62"L; 2.7lbs



8 714936 930165

3 #31-30 Heart Shaped Push Hoe Straight

- Push to weed instead of chop
- Handle made of Dutch ash
- Easy on the back - no bending over!

Head: 2.25"L x 6.25"W; Total: 63"L; 3lbs



8 714936 432201

4 #D25 Heart Shaped Push Hoe P-Grip

- Push to weed instead of chop
- Easy on the back - no bending
- #31-30 head with longer, slanted P-Grip handle

Head: 2.25"L x 6.25"W; Total: 72"L; 3.5lbs



8 714936 932206

5 #31-3160 Push Hoe Dutch

- An economical version of our #31-3016
- Laser-cut Boron steel
- Sharpened head

Head: 1.5"L x 5"W; Total: 62"L; 2.4lbs



8 714936 031602

DISC WEEDERS

4-IN-1 TOOL
AVAILABLE IN 3 LENGTHS

- Lawn Edger
- Patio Knife
- Push/Pull Hoe
- Plant Hole Digger



6



7



8



9



51" HANDLE 10



29" HANDLE 11



10" HANDLE 12

6 #31-0942 Long Handle Patio Knife

- Removes weeds from paver joints
- Use hook side for joints and knife side for beveled edges
- Also available in hand tool (page 12)

Head: 7"L x 2.25"W; Total: 55"L; 1lb



8 714936 030612

7 #31-9700 Long Handle Triangle Patio Knife

- 3 V-shaped weeding blades
- 2 wide and one narrow for different shaped bevels on pavers
- Also available as hand tool (page 12)

Head: 2"L x 1.75"W; Total: 55"L x 1.75"W; 1.32lbs



8 714936 097004

8 #31-0943 Long Handle V-Groove Paver Cleaner

- Easily clean out between pavers and other narrow spaces
- Two different shaped V's for paver edges
- Also available as hand tool (page 12)

Head: 4"L x 0.5"W; Total: 55"L; 1lb



8 714936 099015

9 #31-3942 Long Handle Stirrup Hoe

- A cultivator and stirrup hoe in one!
- Cultivate tough soil with one side
- Cut weeds off at the roots with the other
- Available in short handle and dropgrip versions (pages 9 & 21)

Head: 4.5"L x 4"W; Total: 59"L; 1lb



8 714936 039424

10 #31-0912 62" Disc Weeder

Head: 2.75"D; Handle: 51"L; Total: 62"L; 2lbs



8 714936 030728

11 #31-0911 37" Disc Weeder

Head: 2.75"D; Handle: 29"L; Total: 37"L; 1lb



8 714936 030711

12 #31-0907 Hand Disc Weeder

Head: 2.75"D; Handle: 10"L; Total: 12.5"L; 0.5lbs



8 714936 030704

WEED WARRIORS

Hand-forged boron steel heads with tubular steel handles and ergonomic grips make the Weed Warriors from Holland the ultimate weapon in the fight against weeds. Keep all four designs in your arsenal and you're sure to win the war on weeds!

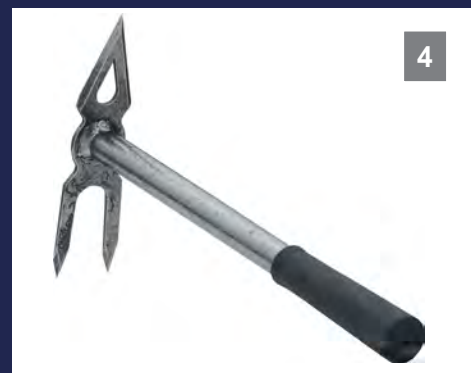
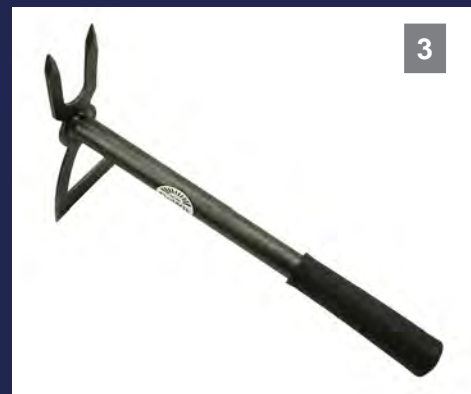
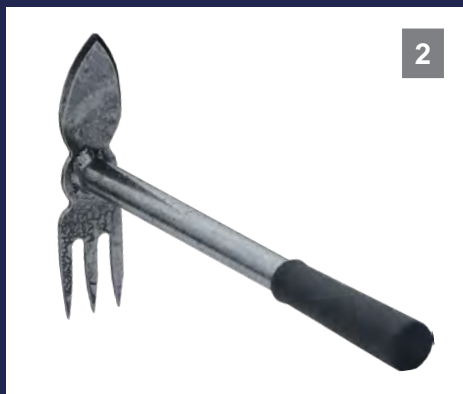
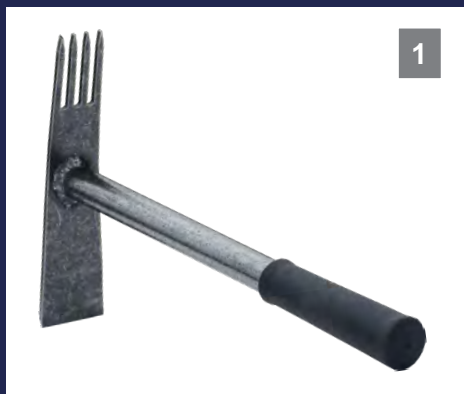

1 #31-3080 Comby 4-Tine Cultivator/Straight Edge Hoe

- A versatile hoe and cultivator combo
- Strong and durable, makes light work of breaking through tough soil
- Guaranteed a lifetime

Head: 7.7"L x 1.9"W; Total: 13.6"L; 1.1lbs



8 714936 030803

2 #31-3078 Comby 3-Tine Cultivator/Heart Shaped Hoe

- A versatile hoe and cultivator combo
- Heart-shaped blade for digging and 3-tine cultivator for loosening tough soil
- Perfect tool to dig and make small furrows
- Guaranteed a lifetime

Head: 7.7"L x 1.9"W; Total: 13.6"L; 1.1lbs



8 714936 030780

3 #31-3075 Comby 2-Tine Cultivator/Wide Edge Chopping Hoe

- Wide edge makes easy work of cleaning borders, removing old weed growth and breaking up soil
- Strong and durable tines break up clay/soil before planting
- Guaranteed a lifetime

Head: 7.5"L x 1.9"W; Total: 13.6"L; 1.1lbs



8 714936 030759

4 #31-3079 Comby 2-Tine Cultivator/Diamond Hoe

- A versatile hoe and cultivator combo
- Aggressive tool for breaking up clay
- Loosens soil with the heavy-duty tines for easy removal of weeds and their roots
- Guaranteed a lifetime

Head: 7.5"L x 1.9"W; Total: 13.6"L; 1.1lbs



8 714936 030797

THE ULTIMATE
WEAPONS IN
THE FIGHT
AGAINST
WEEDS



5

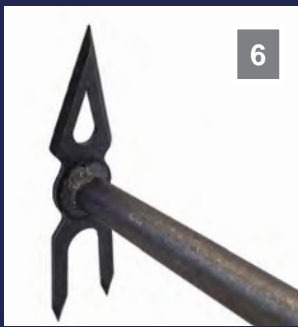

6

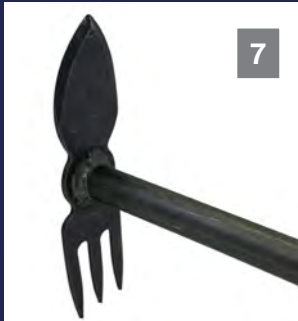

7



8



9

**5 #31-4601 Comby Long Handle
4-Tine Cultivator/Straight Edge Hoe**

- Versatile hoe and cultivator combo
- Long handle is ideal for raised beds
- Strong and durable, makes light work of breaking through tough soil
- Guaranteed a lifetime

Head: 7.5"L x 2.5"W; Total: 32"L; 2lbs



8 714936 046019

**6 #31-4602 Comby Long Handle
2-Tine Cultivator/Diamond Shaped Hoe**

- Versatile hoe and cultivator combo
- Aggressive tool for breaking up clay
- Loosens soil with the heavy-duty tines for easy removal of weeds and their roots
- Guaranteed a lifetime

Head: 7.5"L x 2.8"W; Total: 32"L; 2lbs



8 714936 046026

**7 #31-4603 Comby Long Handle
3-Tine Cultivator/Heart Shaped Hoe**

- Versatile hoe and cultivator combo
- Heart-shaped blade for digging and 3-tine cultivator for loosening tough soil
- Perfect tool to dig and make small furrows
- Guaranteed a lifetime

Head: 7.5"L x 2.8"W; Total: 32"L; 2lbs



8 714936 046033

**#31-7814 & #31-7812
Bad Ass & Flat Nose Trowels**

- Heavy duty trowel for the avid gardener
- Solid one-piece design
- Strong yet lightweight with unrivaled Dutch-made quality
- Hand forged from recycled boron steel

**8 #31-7814
Bad Ass Trowel**

Total: 12"L x 4"W; 2.5lbs



8 714936 078140

**9 #31-7812
Flat Nose Trowel**

Total: 10"L x 3.6"W; 2.2lbs



8 714936 078140





1



2



3



See how the Broadfork can make quick work of preparing soil for planting

1 #31-3066 Long Handle Bulb Planter

- Digs 2.5" holes for bulbs
- Long T-handle and foot step for ease of use
- Short handle on page 11

Head: 2.5"D; Total: 42"L; 2.5lbs



8 714936 030667

2 #31-4210 Dutch Bulb Planter

- Constructed from tubular steel
- Comfortable hand grips
- Makes easy work of digging bulb holes
- Can also be used for post holes
- Great for turning compost

Head: 8.5"L x 2.5"W; Total: 49.5"L; 4lbs



8 714936 042103

3 #31-9114 Galvanized Broadfork "Grelinette"

- The "tiller" for the true environmentalist
- Strong forged tines break up/till planting beds with ease
- Prepares one-foot swath with each pull

Head: 9.4"L x 14.2"W; Total: 40.9"L; 7.3lbs



8 714936 091149

DEWIT COUNTERTOP DISPLAY

THE PERFECT OPTION IN YOUR GIFT AREA OR AT THE CHECKOUT COUNTER FOR IMPULSE BUYS! FEATURES A NICE COMBINATION OF THE TOP 5 DEWIT SHORT HANDLE TOOLS FOR WEEDING, PLANTING, AND MORE!

#1055 DeWit Countertop Display

Part #	Description	QTY
#31-0904	Short Handle 3 Tine Cultivator	3
#31-3000	Forged Trowel	3
#31-3002	Forged Transplant Trowel	3
#31-0905	Dandelion Weeder	3
#31-3004	Forged Hand Fork	3
#31-9555	Countertop Display (1/2 price)	1
		15
#1055POG	Without display stand	



#1055 Countertop Display
16.5"W x 10"D x 20.5"H

DEWIT TOP SELLING STARTER DISPLAY

- 63 tools total
- Features 21 of the best selling DeWit short handle and perennial tools
- The perfect way to introduce the world's best garden tool into your garden center!

#1027W DeWit Top Selling Starter Display

Part #	Description	QTY
Row 1		
#31-3000	Forged Trowel	3
#31-3002	Forged Transplant Trowel	3
#31-3011	Trowel Small X-treme	3
#31-3032	Rock'N Root Trowel	3
#31-0906	Potting Trowel	3
Row 2		
#31-0916	Cape Cod Weeder Left Hand	3
#31-0905	Dandelion Weeder	3
#31-0915	Cape Cod Weeder Right Hand	3
#31-0904	3-Tine Cultivator Short Handle	3
#31-0903	Short Handle 5-Tine Cultivator	3
Row 3		
#31-2902	Japanese Handhoe, Left Hand	3
#31-2901	Japanese Handhoe, Right Hand	3
#31-0909	Crocus Bulb Planter	3
#31-3004	Forged Hand Fork	3
#31-3015	Handfork Small X-Treme	3
Row 4		
#F11	Dutch Hand Hoe, Left Hand	3
#31-3087	Wooden Dibber With Brass Tip	3
#F10	Dutch Hand Hoe, Right Hand	3
#31-3031	Serrated Farmer's Dagger	3
#31-3482	Weedpopper	3
#31-0910	Patio Knife	3
#1500B	Black Display (Half Price)	
		63
#1027WPOG	Tools Only/No Display Stand	



#1027W DeWit Top Selling Starter Display
18.5"W x 22"D x 87"H

GARDENING TOOLS • DEWIT

DEWIT TOP SELLER ADDER DISPLAY

- 57 tools total
- Features the next 19 best selling DeWit short handle tools

#1112W DeWit Top Seller Adder Display		
PART #	DESCRIPTION	QTY
Row 1		
#31-3346	Welldone Trowel	3
#31-3344	Welldone Serrated Trowel	3
#31-3034	Tulip Trowel	3
#31-3005	Snake Tongue Trowel	3
#31-3454	Bio Daisy Grubber	3
Row 2		
#31-3453	Bio V Groove Cleaner	3
#31-3456	Bio Weed Fork	3
#31-3451	Bio 3-Tine Cultivator	3
#31-3452	Bio Soil Aerator	3
#31-3450	Bio Onion Handhoe	3
#31-3457	Bio Hand Rake w/out Solid Section	3
Row 3		
#31-3940	Combi Cultivator	3
#31-2950	Mini Shovel With Ash Grip	3
#31-0907	Garden Disc Weeder	3
#31-3055	Spring Tine Cultivator	3
Row 4		
#31-2906	Korean Hand Hoe	3
#31-3047	British Style Bulb Planter	3
#31-2907	Korean Handhoe Left Handle	3
#31-0914	V-Paver Cleaner	3
#1500B	Black Display (Half Price)	
		57
#1112WPOG	Tools Only/No Display Stand	



#1112W DeWit Top Seller Adder Display
18.5"W x 22"D x 87"H

DEWIT SPECIALTY TOOL DISPLAY

- 45 tools total
- Features a wide selection of DeWit short handle, drop grip and best selling long handle tools for the serious gardener!

#1127W DeWit Specialty Tool Display		
PART #	DESCRIPTION	QTY
#31-3029	Flathead Trowel	3
#31-8737	RH Cape Cod Wdr w/ Drop Grip Hndl	3
#31-3008	Bottle Opener Trowel	3
#31-20	Half Moon Hoe Strait Hndl	3
#31-0925	Traditional Garden Knife	3
#31-10	Diamond Hoe Straight Hndl	3
#31-3337	Sieve Trowel	3
#31-8506	5 Tine Cultivator W/P-Hndl	3
#31-1110	Dewit Transplanter	3
#31-0919	Perennial Spade	3
#F20	Perennial Planter	3
#31-0930	Onion Hoe	3
#31-0805	Corkscrew Wdr Short Hnd	3
#31-3028	Trowel With Large w/ Cutting Edge	3
#F30	Perennial Fork	3
#1500B	Black Display (Half Price)	
		45
#1127WPOG	Tools Only/No Display Stand	



#1127W DeWit Specialty Tool Display
18.5"W x 22"D x 87"H



TERRA Garden™

A Modern Take on a Classic Design

Functional design and quality at the right pricepoint



We know you have a lot of options for tools, so why this line? It's simple, our Tierra Garden tools incorporate everything your customers are looking for: functional design and quality at the right pricepoint. This line is all about exceptional value.

- Our classic tools have a timeless, sleek design
- Made with hardwood ash handles
- Rust-resistant Stainless Steel heads
- Made to last season after season
- 5-Year Warranty against manufacturer defects and workmanship



1 #35-1801 Stainless Steel Transplanter

Head: 6"L x 2.5"W
Total: 13"L; 0.55lbs



8 13269 01801 9

2 #35-1803 Stainless Steel Scoop

Head: 6"L x 3.5"W
Total: 12.5"L; 0.45lbs



8 13269 01803 3



1



4



6



2



7



3



5



8

**3 #35-1800
Stainless Steel
Trowel**

Head: 6"L x 3.3"W
Total: 13"L; 0.65lbs



**5 #35-1802
Stainless Steel
Cultivator**

Head: 4"L x 3.25"W
Total: 12.5"L; 0.65lbs



**7 #35-1806
Stainless Steel
Hand Fork**

Head: 4.5"L x 3"W
Total: 11.5"L; 0.5lbs



**4 #35-1804
Stainless Steel
Ball Weeder**

Head: 6.75"L x 2"W
Total: 22.5"L; 0.55lbs



**6 #35-1805
Stainless Steel
Shrub Rake**

Head: 7"L x 4.5"W
Total: 13"L; 0.35lbs



**8 #35-1807
Stainless Steel
Dibber**

Head: 5"L x 1.5"W
Total: 12"L; 0.45lbs





TDI Exclusive

#900105
Trake®

- The ULTIMATE garden tool!
- It's a trowel, it's a rake, it's the TRAKE®!
- Lengthy 17" handle; only weighs 1lb
- Less bending and less back strain
- Angled handle provides leverage
- Great for digging and cultivating
- Perfect size to cultivate between narrow rows
- Rugged die-cast alloy blade and shaft won't rust, bend, or distort; solid die-cast tines can't bend
- Terradynamic trowel design penetrates soil easily
- Permanent graduations on trowel blade allow precision for bulb and seed planting
- Non-slip vinyl coating on grip with thumb recess
- Ergonomic handle design works in both directions
- The Trake is exclusive to Tierra Garden in the U.S.

Comes with a convenient hanging tag!





SK INDOOR POTTERY



MORE THAN POTTERY...

THE HIGHEST
QUALITY
MATERIALS
MAKE ALL THE
DIFFERENCE

- Made in Germany with natural, native clay
- 100% waterproof pottery
- 130,000 unit daily capacity
- Pots are in the kiln for 5 hours at 1872°F
- 100% rainwater is used in production of all SK pottery
- Clay residue is recycled back into production
- Pots do not have draining holes, so no worry of damage to furniture
- Minimum \$1,000 order
- 10% discount for full pallet (same SKU) orders



IT'S CERAMIC ART.

Founded in 1893, the company has spent the last 125 years developing all the attributes that make up a successful business. Over the last century, Soendgen Keramik has grown from a small local craft shop to an international player. This commitment to progress has accompanied, inspired and motivated SK Pottery. Always at the cutting edge, the company is known for high-quality, trend-conscious ceramics.

SMALL POTS

3.1" – 3.9" DIAMETER,
INDOOR



1 Laos, 3.1" Diameter
• High-gloss glazed surface finish—
perfect for succulents
6 pots per tray, 2.0 lb. tray weight

#3-082511
Blue-Gray 

#3-082512
Warm-Gray 



2 Livorno, 3.1" Diameter
• Features modern tile motifs—
perfect for succulents
7 pots per tray, 2.5 lb. tray weight

#3-088024
Mosaic Blue-Gray 

#3-088025
Mosaic Amber 

#3-088023
Mosaic Turquoise 

3 Las Vegas, 3.1" Diameter
• Flashy Vegas colors—
perfect for succulents
7 pots per tray, 2.5 lb. tray weight

#3-080050
White 

#3-081582
Red 

#3-082281
Anthracite 

4 Vintage Animals, 3.1" Diameter
• Vintage look with animal motifs
7 pots per tray, 2.5 lb. tray weight

#3-088071
Colibri 

#3-088072
Papillon 

#3-088073
Libellule 

#3-088074
Mesange 

5 Vintage Garden, 3.9" Diameter
• Vintage look with botanical motifs
4 pots per tray, 2.5 lb. tray weight

#3-108075
Botanical
Garden 

#3-108077
Love Flowers 

MEDIUM POTS

4.7"-5.1" DIAMETER, INDOOR



6



7



8



9



10



11

6 Alberta Fashion, 4.7" Diameter

- Natural matte wood look
7 pots per tray, 6.2 lb. tray weight

#3-122363
Wood Optics
Gray



4 006063 299975

#3-122365
Wood Optics
Brown



4 006063 300053

7 Delphi, 4.7" Diameter

- Shadowed edge in the foot gives the pots a floating appearance
8 pots per tray, 5.9 lb. tray weight

#3-120050
White



4 006063 619896

#3-122511
Blue-Gray



4 006063 620212

#3-122512
Warm-Gray



4 006063 620243

8 Singapur, 5.1" Diameter

- Orchid vase with elegant design and trendy glazed appearance
6 pots per tray, 7.2 lb. tray weight

#3-150050
White



4 006063 582923

#3-132511
Blue-Gray



4 006063 625019

#3-132512
Warm-Gray



4 006063 625026

9 Dallas Esprit, 5.1" Diameter

- Ideal container for green & flowering plants
6 pots per tray, 5.2 lb. tray weight

#3-130207
Anthracite



4 006063 307632

#3-130847
White



4 006063 307649

10 Bergamo, 5.1" Diameter

- Trendy glaze look with a special in-and-out effect
5 pots per tray, 4.8 lb. tray weight

#3-132606
Lavender



4 006063 306918

#3-132605
Light Gray



4 006063 306833

#3-132608
Mint Green



4 006063 307038

11 Basel Fashion, 5.1" Diameter

- Ideal combination for the design of a natural home
5 pots per tray, 4.6 lb. tray weight

#3-131943
Black



4 006063 284957

#3-131851
Light Gray



4 006063 285039

*Minimum \$1,000 order

Designs subject to change

CLAY POTTERY • SK POTTERY

MEDIUM POTS

4.7"-5.1" DIAMETER, INDOOR

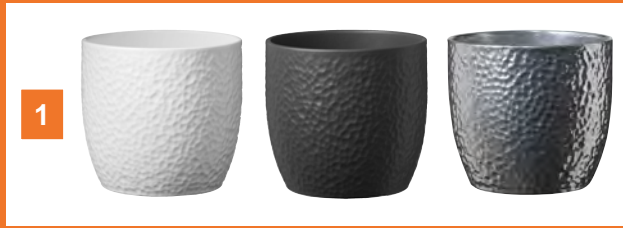

1 Boston, 5.1" Diameter

- Matte ceramic look with a special hammered design
- 5 pots per tray, 4.8 lb. tray weight

#3-084713
White



#3-020713
Anthracite



#3-131874
Shiny Silver



2 Basel Full Color, 5.1" Diameter

- Harmoniously balanced shape creating a stylish, timeless design
- 5 pots per tray, 4.6 lb. tray weight

#3-005013
White



#3-131582
Red



3 Dallas Structure, 5.1" Diameter

- Cross-hatched surface
- 6 pots per tray, 5.2 lb. tray weight

#3-138090
Green Structure



#3-138091
Gray Structure



4 Baku Pearl, 5.1" Diameter

- Modern shape with a pearl relief design
- 5 pots per tray, 4.6 lb. tray weight

#3-132202
Crème Rose



#3-132203
Gray Beige



#3-132204
Celadon Green



#3-132703
High Gloss
Green Blue



5 Latina, 5.1" Width

- Square with ombre or gloss finish
- 4 pots per tray, 6.6 lb. tray weight

#3-132720
Olive Green Effect



#3-132721
Mystic Lilac Effect



#3-132722
Deep Blue Effect



#3-130595
Shiny White



LARGE POTS

5.5" – 6.3" DIAMETER, INDOOR



6 Boston Metallic, 5.5" Diameter

- Refracts light in the three-dimensional surface
- 4 pots per tray, 5.0 lb. tray weight

#3-141874
Shiny Silver



7 Merina, 5.9" Diameter

- Classic orchid vase
- 6 pots per tray, 7.1 lb. tray weight

#3-152299
Matte Pastel Rose



#3-151448
Matte Lavender



#3-151977
Shiny Mystic Gray



#3-151857
Metallic Gray Beige



8 Dallas Style, 5.5" Diameter

- Smooth, sleek surface
- 6 pots per tray, 5.9 lb. tray weight

#3-142281
Anthracite



#3-141582
Red



#3-140050
White



9 Laos, 5.5" Diameter

- Classic cylindrical shape with artistic, modern lines
- 4 pots per tray, 4.5 lb. tray weight

#3-142511
Blue-Gray



#3-142512
Warm-Gray



10 Sonora, 5.5" Diameter

- Sandy surface and wave design simulates the ocean
- 6 pots per tray, 6.2 lb. tray weight

#3-141844
White



#3-141843
Anthracite



11 Alberta Fashion, 5.9" Diameter

- Naturally matte wood look
- 4 pots per tray, 6.2 lb. tray weight

#3-152363
Wood Optics Gray



#3-152365
Wood Optics Brown



#3-152366
Shiny Wood Optics Gray



*Minimum \$1,000 order

Designs subject to change

CLAY POTTERY • SK POTTERY

LARGE POTS 5.5" – 6.3" DIAMETER, INDOOR



1 Basel Elegance, 6.3" Diameter

- Sleek design with shimmer
- 4 pots per tray, 6.4 lb. tray weight

#3-162719
Shiny Pearl
Rose



#3-162399
Shiny Light
Gray



#3-161857
Gray Beige
Metallic



2 Delphi, 6.3" Diameter

- Shadowed edge in the foot gives the pots a floating appearance
- 4 pots per tray, 5.3 lb. tray weight

#3-162511
Blue-Gray



#3-162512
Warm-Gray



3 Boston, 6.3" Diameter

- Matte finish with a hammered design
- 4 pots per tray, 7.0 lb. tray weight

#3-160847
White



4 Basel Full Color Bowl, 6.3" Diameter

- Harmoniously balanced shape
- 3 pots per tray, 2.9 lb. tray weight

#3-005016
Shiny White



5 Macrame Hangers

- Bringing back the 70's with macrame
- Perfect accent for your indoor plants
- 10 per case

#3-902412
Natural Beige



#3-902410
Natural Green



#3-902411
Shiny Gray



EXTRA LARGE POTS

6.7" - 8.3" DIAMETER, INDOOR



**NEW
LARGER
SIZES!!**

6 **Basel Full Color Bowl, 7.9" Diameter**
 • Harmoniously balanced shape creating a stylish, timeless design
 2 pots per tray, 3.2 lb. tray weight
#3-200050
Shiny White



9 **Baku Pearl, 7.5" Diameter**
 • Modern shape with a pearl relief design
 4 pots per tray, 11 lb. tray weight
#3-192203
Gray-Beige



7 **Bergamo, 9.5" Diameter**
 • Trendy glaze look with ridges
 1 pots per tray, 5.2 lb. tray weight
#3-242605
Light Gray



#3-192703
High Gloss Green Blue



8 **Basel Fashion, 8.3" Diameter**
 • Harmonious colors in muted matte
 1 pots per tray, 3.8 lb. tray weight
#3-211943
Matte Black
#3-211851
Matte Light Gray
#3-212604
Matte Linden Green



10 **Latina, 6.7" Width**
 • Square design
 4 pots per tray, 11.9 lb. tray weight
#3-170207
Matte Anthracite



***Minimum \$1,000 order**

Designs subject to change

CLAY POTTERY • SK POTTERY

SK POTTERY HOME COLLECTION DISPLAY

#SK1000 Home Collection Display		
Part #	Diameter and Description	QTY
Shelf 1		
#3-005016	6.3" Basel -- White	12
#3-082511	3.1" Laos -- Blue-Gray	12
#3-082512	3.1" Laos -- Warm-Gray	12
Shelf 2		
#3-200050	7.9" Basel -- White	6
#3-088024	3.1" Livorno -- Mosaic Blue-Gray	14
#3-088025	3.1" Livorno -- Mosaic Amber	14
#3-088023	3.1" Livorno -- Mosaic Turquoise	14
Shelf 3		
#3-150050	5.1" Singapur -- White	12
#3-132511	5.1" Singapur -- Blue-Gray	12
#3-132512	5.1" Singapur -- Warm-Gray	12
Shelf 4		
#3-120050	4.7" Delphi -- White	24
#3-122512	4.7" Delphi -- Warm-Gray	16
#3-122511	4.7" Delphi -- Blue-Gray	16
Shelf 5		
#3-130847	5.1" Dallas Esprit -- White	30
#3-242605	9.5" Bergamo -- Light Gray	4
#3-DISPLAY	Display only	
		210
#SK1000POG	Pottery Only/No Display Stand	



Learn more about
SK Pottery



Designs subject to change

WEB TierraGarden.com • EMAIL sales@tdibrands.com • PHONE 800.992.1220

#SK1000
SK Pottery
Home Collection Display
25"W x 16.5" D x 62" H, 275 lbs

SK POTTERY NATURAL COLLECTION DISPLAY

#SK2000 Natural Collection Display		
Part #	Diameter and Description	QTY
Shelf 1		
#3-082511	3.1" Laos -- Blue-Gray	12
#3-082512	3.1" Laos -- Warm-Gray	12
#3-088024	3.1" Livorno -- Mosaic Blue-Gray	14
#3-088025	3.1" Livorno -- Mosaic Amber	14
#3-088023	3.1" Livorno -- Mosaic Turquoise	14
Shelf 2		
#3-141844	5.5" Sonora -- White	12
#3-161843	5.5" Sonora -- Anthracite	12
#3-132605	5.1" Bergamo -- Light Gray	10
#3-132608	5.1" Bergamo -- Mint Green	10
Shelf 3		
#3-122511	4.7" Delphi -- Blue-Gray	16
#3-122512	4.7" Delphi -- Warm-Gray	16
#3-162511	6.3" Delphi -- Blue-Gray	8
#3-162512	6.3" Delphi -- Warm-Gray	8
Shelf 4		
#3-130207	5.1" Dallas Esprit -- Anthracite	18
#3-142511	5.5" Laos -- Blue-Gray	8
#3-142512	5.5" Laos -- Warm-Gray	8
#3-150050	5.1" Singapur -- White	12
Shelf 5		
#3-152363	5.9" Alberta Fashion -- Wood Optics Gray	8
#3-152366	5.9" Alberta Fashion -- Shiny Wood Optics Gray	8
#3-152365	5.9" Alberta Fashion -- Wood Optics Brown	8
#3-DISPLAY	Display only	
		228
#SK2000POG	Pottery Only/No Display Stand	



Learn more about
SK Pottery



Designs subject to change

#SK2000
SK Pottery
Natural Collection Display
25"W x 16.5" D x 62" H, 270 lbs

SK POTTERY FASHION COLLECTION DISPLAY

#SK3000 Fashion Collection Display		
Part #	Diameter and Description	QTY
Shelf 1		
#3-081582	3.1" Las Vegas -- Red	14
#3-082281	3.1" Las Vegas -- Anthracite	14
#3-080050	3.1" Las Vegas -- White	14
#3-088023	3.1" Livorno -- Mosaic Turquoise	14
#3-088024	3.1" Livorno -- Mosaic Blue-Gray	14
Shelf 2		
#3-141844	5.5" Sonora -- White	12
#3-132605	5.1" Bergamo -- Light Gray	10
#3-132608	5.1" Bergamo -- Mint Green	10
#3-141843	5.5" Sonora -- Anthracite	12
Shelf 3		
#3-142281	5.5" Dallas Style -- Anthracite	18
#3-141582	5.5" Dallas Style -- Red	18
#3-140050	5.5" Dallas Style -- White	18
#3-130207	5.1" Dallas Esprit -- Anthracite	12
Shelf 4		
#3-131943	5.1" Basel Fashion -- Black	10
#3-005013	5.1" Basel Full Color -- White	10
#3-131851	5.1" Basel Fashion -- Light Gray	10
#3-131582	5.1" Basel Full Color -- Red	10
Shelf 5		
#3-131874	5.1" Boston Metallic -- Shiny Silver	10
#3-084713	5.1" Boston -- White	10
#3-020713	5.1" Boston -- Anthracite	10
#3-141874	5.5" Boston Metallic -- Shiny Silver	8
#3-160847	6.3" Boston -- White	8
#3-DISPLAY	Display only	
		266
#SK3000POG	Pottery Only/No Display Stand	



Learn more about
SK Pottery



Designs subject to change

#SK3000
SK Pottery
Fashion Collection Display
25"W x 16.5" D x 62" H, 285 lbs

WEB TierraGarden.com • EMAIL sales@tdibrands.com • PHONE 800.992.1220

SK POTTERY ALLURE COLLECTION DISPLAY

#SK5000 Allure Collection Display		
Part #	Diameter and Description	QTY
Shelf 1		
#3-088071	3.1" Vintage Animals -- Colibri	14
#3-088072	3.1" Vintage Animals -- Papillon	14
#3-088073	3.1" Vintage Animals -- Libellule	14
#3-088074	3.1" Vintage Animals -- Mesange	14
#3-108075	3.9" Vintage Garden -- Botanical Garden	8
#3-108077	3.9" Vintage Garden -- Love Flowers	8
Shelf 2		
#3-138090	5.1" Dallas Structure -- Green Structure	12
#3-138091	5.1" Dallas Structure -- Gray Structure	12
#3-122363	4.7" Alberta -- Wood Optics Gray	14
#3-122365	4.7" Alberta -- Wood Optics Brown	14
Shelf 3		
#3-132204	5.1" Baku Pearl -- Celadon Green	10
#3-132203	5.1" Baku Pearl -- Gray Beige	10
#3-132202	5.1" Baku Pearl -- Crème Rose	10
#3-132703	5.1" Baku Pearl -- High Gloss Green Blue	10
Shelf 4		
#3-132720	5.1" Latina Effect -- Olive Green Effect	8
#3-132721	5.1" Latina Effect -- Mystic Lilac Effect	8
#3-132722	5.1" Latina Effect -- Deep Blue Effect	8
Shelf 5		
#3-162719	6.3" Basel Elegance -- Shiny Pearl Rose	8
#3-161857	6.3" Basel Elegance -- Gray Beige Metallic	8
#3-162399	6.3" Basel Elegance -- Shiny Light Gray	8
#3-DISPLAY	Display only	
		212
#SK5000POG	Pottery Only/No Display Stand	



#SK5000
SK Pottery
Allure Collection Display
 25"W x 16.5" D x 62" H, 260 lbs



Learn more about
 SK Pottery



Designs subject to change

SK POTTERY CHIC COLLECTION DISPLAY

#SK6000 Chic Collection Display		
Part #	Diameter and Description	QTY
Shelf 1		
#3-132204	5.1" Baku Pearl -- Celadon Green	10
#3-005016	6.3" Basel -- White	6
#3-132606	5.1" Bergamo -- Lavender	10
Shelf 2		
#3-170207	6.7" Latina -- Anthracite	4
#3-130595	5.1" Latina -- White	8
Shelf 3		
#3-152299	5.9" Merina Pastel -- Matte Pastel Rose	12
#3-151857	5.9" Merina Chic -- Metallic Gray-Beige	12
#3-151977	5.9" Merina Chic -- Shiny Mystic Gray	12
#3-151448	5.9" Merina Pastel -- Matte Lavender	12
Shelf 4		
#3-192203	7.5" Baku Pearl -- Gray-Beige	4
#3-132202	5.1" Baku Pearl -- Crème Rose	10
#3-192703	7.5" Baku Pearl -- High Gloss Green-Blue	4
Shelf 5		
#3-212604	8.3" Basel Fashion -- Linden Green	4
#3-211851	8.3" Basel Fashion -- Light Gray	4
#3-211943	8.3" Basel Fashion -- Black	4
#3-DISPLAY	Display only	
		116
#SK6000POG	Pottery Only/No Display Stand	

NEW



Learn more about
SK Pottery



Designs subject to change

#SK6000
SK Pottery
Chic Collection Display
25"W x 16.5" D x 62" H, 255 lbs

WEB TierraGarden.com • EMAIL sales@tdibrands.com • PHONE 800.992.1220



KIDS GARDENING



KITS FOR KIDS

From tool, growing and watering can kits , Little Pals has what kids want and need!



1 #7-LP441 and #7-LP463
Little Pals Pink and Blue
Tool Pouch Kits

- Just right for keeping everything at hand during a stint in the garden!
- Includes green tool pouch, hand trowel, hand fork and childrens garden gloves
- Gloves have a wide cuff and extra fabric over the knuckles to help protect little hands
- One size; **ages 3 to 10**

10.6"L x 9.4"W x 2"D, 0.7lbs *Glove Designs May Vary*

#7-LP441 Blue Kit

#7-LP463 Pink Kit



BRIGHTLY-COLORED WATERING CANS ARE PROTECTED BY A KID-FRIENDLY COATING TO HELP PREVENT RUSTING AND ARE AN EXCELLENT VALUE FOR THE MONEY.



2 #7-LP114, #7-LP431, and #7-LP902 Little Pals Watering Can Kits

- A fun and easy way to get the kids involved with gardening!
- Set includes metal watering can, gloves, and hand trowel - sized perfectly for little hands
- Use the 3 pint watering can for easy storage of tool and gloves
- One size; ages 3 to 10

9.1"L x 11.4"W x 5.1"D, 0.9lbs *Glove Designs May Vary*

#7-LP902 Pink Kit



5 013556 129021

#7-LP114 Blue Kit



5 013556 131147

#7-LP431 Green Kit



5 013556 124316

3 #7-LP625 Little Pals Kids Gloves

- Warm lined cotton gloves to keep little hands clean and safe
- Quality jersey comfort knitted wrist
- One size; ages 3 to 7

9"L, 0.1bs *Designs May Vary*



5 013556 126259

ACTIVITY KITS

Brightly colored kits containing hand tools, gloves and a kneeling pad are just right for your planting partner!



1



2

1 #7-LP380 and #7-LP381 Little Pals Pink and Blue Junior Garden Kits

- Includes carry/storage bag with handy pockets, hand trowel and hand fork, kids gloves, and a matching bucket
- Tools have metal heads and sturdy wooden handles
- Metal bucket has wooden handle

8.3"L x 7.1"W x 7.9"D, 1.0lbs
Glove Designs May Vary

#7-LP380 Pink Kit



5 013556 123807

#7-LP381 Blue Kit



5 013556 123814



#7-LP381 Blue Kit



#7-LP380 Pink Kit

2 #7-LP111 and #7-LP697 Little Pals Pink and Green Activity Kits

- Let the gardening fun begin!
- Each kit contains a foam kneeler, matching hand trowel and hand fork, and a pair of children's gloves for extra protection
- Kneeler measures 13"L x 6"W
- Tools have metal heads and sturdy wooden handles
- **One size: ages 3 to 10**

13"L x 5.9"W x 2"D, 0.6lbs

Glove Designs May Vary

#7-LP111 Pink Kit



5 013556 131116

#7-LP697 Green Kit



5 013556 126976

LITTLE PALS KIDS DISPLAY

GARDENING ACCESSORIES MADE FOR LITTLE HANDS



If you're looking to offer gardening items for children in your store, the Little Pals Kids Display is a great solution! Featuring a great variety of items, this display takes up little space, but showcases just the right amount of product and the bright colors attract the attention of young and old alike!



#LP3000 Little Pals Kids Display

PART #	DESCRIPTION	QTY
7-LP114	Blue Watering Can Kit	8
7-LP431	Green Watering Can Kit	8
7-LP902	Pink Watering Can Kit	8
7-LP441	Blue Tool Pouch Kit	12
7-LP463	Pink Tool Pouch Kit	12
7-LP625	Kids Glove	40
7-LP381	Blue Junior Garden Kit	8
7-LP380	Pink Junior Garden Kit	8
7-LP111	Pink Activity Kit	12
7-LP697	Green Activity Kit	12
3000N	Cardboard Display only	128
LP3000POG	No Display Stand	

Glove Designs May Vary

KEEP LITTLE HANDS BUSY
WITH TOOLS THAT ARE
PERFECT FOR THE GARDEN,
SANDBOX OR A TRIP TO
THE BEACH!

#LP3000
Little Pals Kids Display
31"W x 12.5" D x 65" H

NOT JUST FOR KIDS!

The size of these tools makes them great options for Seniors and gardeners who prefer smaller tools.

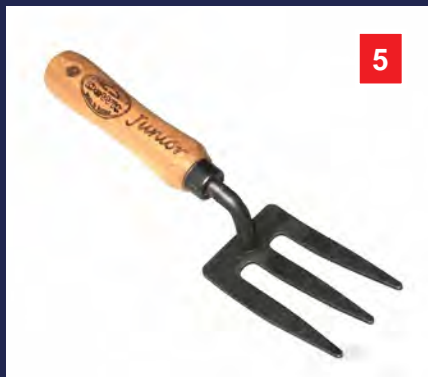

1 #31-3170
Junior Planting Trowel

Head: 5"L x 2.25"W
Total: 9.5"L; 0.3lbs



8 714936 031701

3 #31-3173
Junior Long Handle Spade

Head: 7"L x 4.75"W
Total: 38"L; 1.5lbs



8 714936 031732

5 #31-3171
Junior Hand Fork

Head: 3"L x 2"W
Total: 8"L; 0.25lb



8 714936 031718

2 #31-3172
Junior Long Handle Pt. Spade

Head: 7.5"L x 4.75"W
Total: 38"L; 1.5lbs



8 714936 031725

4 #31-3176
Junior Double Hand Hoe

Head: 5.25"L x 2"W
Total: 8"L; 0.5lb



8 714936 031763

6 #31-3174
Junior Long Handle Shovel

Head: 8"L x 5"W
Total: 39"L; 1.5lbs



8 714936 031749



7



8



9



10



"Junior" tools from DeWit are just the right size for small hands, making it easy and fun to include the little ones in all aspects of gardening. Due to the quality and sharpness of these tools, we recommend them for **ages 8 and up.**

Just like all of our DeWit tools, these are handmade in Holland and guaranteed a lifetime.

7 #31-3175 Junior Long Handle Hoe

Head: 5"L x 2"W
Total: 37"L; 1lb



8 714936 031756

8 #31-3177 Junior Long Handle Dbl Hoe

Head: 6.75"L x 2.75"W
Total: 34"L; 1lb



8 714936 031770

9 #31-3178 Junior Long Handle Rake

Head: 5"L x 2.5"W
Total: 32"L; 1lb



8 714936 031787

10 #31-3179 Junior Long Handle Leaf Rake

Head: 8.5"L x 5.25"W
Total: 38"L; 1.2lbs



8 714936 031794

PERFECT FOR THE YOUNG & THE YOUNG AT HEART!

eurogarden Kids
Made in Europe

Tierra Garden's Eurogarden Kids tool line combines strength and practical design for the perfect lightweight tool. These tools are great for kids and useful for those who find that they enjoy smaller, lighter garden tools over full size tools. They are strong enough to do real garden work and made to last.



- European-made, exceptional quality
- Safe, lead-free paint
- Heavy steel heads
- Thick, 1" diameter handles
- Long handles: 31" to 40" length
- Best seller year after year!
- Available with a display (see opposite page)
- Actual tools colors may vary from picture shown
- Suitable for **ages 5 years & up**

1 #RP40110
Leaf Rake
40"L x 10"W; 1lb



3 #RP40130
Spade
36"L x 4.8"W; 1lb



5 #RP40150
Double Hoe
31"L x 6.8"W; 0.8lb



2 #RP40120
Square Shovel
36"L x 4.8"W; 1.1lbs



4 #RP40140
Soil Rake
31"L x 6"W; 0.75lb



6 #RP40160
Fox Point Shovel
36"L x 5.6"W; 1.1lbs





7



8



9

SHOWCASE THE TOOLS SO LITTLE GARDENERS CAN SEE!

This 2-wheel display is the perfect way to showcase and store our kids tools. Place it by your "kids" section, keep it by the counter for impulse buys, and roll it outside on nice days. It comes complete with 80 tools, 10 units each, of the 8 items on these two pages.

eurogarden Kids
Made in Europe

7 #RP40170
Cultivator
 34"L x 2.4"W; 0.8lb



8 #RP40180
Broom
 32"L x 8"W; 0.9lb



9 #RP401DK Kids Tool Display

#RP401DK Kids Tool Display		
PART #	DESCRIPTION	QTY
#RP40110	Leaf Rake	10
#RP40120	Square Shovel	10
#RP40130	Spade	10
#RP40140	Soil Rake	10
#RP40150	Hoe	10
#RP40160	Fox Point Shovel	10
#RP40170	3-Tine Cultivator	10
#RP40180	Broom	10
#RP40608	Cart (1/2 Display)	1
		80
#RP401DKPOG Without display cart		

Cart: 26"L x 24"W x 25"H, 15.2lbs





1



4



2

ORDER THE "MIXED CASES"
TO GET A VARIETY OF
COLORS AND PRODUCTS!

Suitable for ages 3-10



4



3



4

1 1 Pt. Mini Plastic Watering Can

- Like a smaller version of our standard PVC watering cans
 - Kids can easily water plants
 - Cases sold by individual color
- 10"W x 2.75"D x 5.5"H, 0.15lb

#5001B
Blue



#5001G
Green



#5001P
Pink



#5001MC 15-Piece Mixed Case
5 of each color



2 Kids 1 Pt. Metal Watering Can

- Kids can water plants like grown ups with these brightly colored watering cans
 - Sold in 16 piece, assorted cases: pink, green, blue, and orange
- 9"W x 3.5"D x 6"H, 0.3lb

#5070 (Min 16)
Mixed Colors



3 Kids 2 Quart Metal Pail

- Children can easily make sand castles, carry water, and toys
 - Sold in 16 piece, assorted cases: pink, green, blue, and orange
- 7.25"W x 7.25"D x 6"H, 0.5lb

#5080 (Min 16)
Mixed Colors



4 Kids Small Hand Tools

- These colorful garden tools are perfect for the youngest gardeners
- Great for the garden or sandbox!

#G340
Square Trowel

8.25"L x 2.75"W, 0.2lb



#G350
Round Trowel

8.5"L x 2.5"W, 0.2lb



#G360
Hand Fork

6.25"L x 2.75"W, 0.2lb



#G330 36-Piece Mixed Case

12 of each tool



DELUXE CHILDREN'S SANDBOX

This quality constructed wooden sandbox has some wonderful design features.

The vinyl roof offers protection from sun and rain, and can be cranked all the way down when not in use. This keeps debris from collecting in the sandbox and offers a great solution to the ever-present problem of keeping cats out!

Made in Austria from water-treated pine wood safe for children and pets.

Assembly required.

Ground shippable.

Don't be fooled by cheap imitations.

This is the original made in Austria!



5

#G31001 Deluxe Children's Sandbox

- Vinyl roof has highest possible UV Rating (90) to safeguard children from harmful rays
- Retractable roof keeps out lawn debris and animals
- Bench-like seats along edge
- Sits on ground, no bottom floor - can be moved easily
- Special waterproofing process - safe for children, pets, and environment
- Assembly required

Holds up to 400lbs of sand
56"L x 56"W x 8"H bench, 52" total height, 48lbs
44"L x 44"W play area



2-IN-1 BENCH & PICNIC TABLE



#2-1909 2-in-1 Picnic Table

- Easily converts from a table to a bench and back again in only seconds
- Drilled for umbrella pole
- Picnic table comfortably seats four while the bench is perfect for two or three
- Sturdy yet compact construction allows for easy transport from one spot to the next
- Made from Canadian Hemlock hardwood
- Do not be fooled by cheap Chinese fir imitations!
- Compact design, perfect for kids of all ages
- Assembly required

PICNIC TABLE POSITION

Overall Dimensions; 54.25"L X 58"W X 30" H
Seats: 51"L X 7.5"W X 19"H Top of Table: 54.25"L X 19"W

BENCH POSITION

Overall Dimensions: 54.25"L X 28"W X 33"H
Seat: 51"L X 18.5"W X 19"H

Pack: 57.6"L x 23.2"W x 6.3"H, 44 lbs





PLANT STAKES & SUPPORTS

CLASSIC STAKES

- The basis of the plant support
- Supports for all plant sizes
- Will last a lifetime!
- Safety knob for eye protection
- Each stake comes with one coupler (to attach rings, grids or border edges)

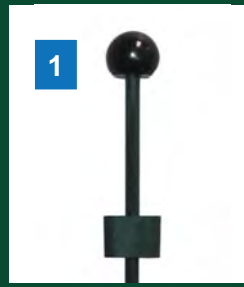

USE MULTIPLE COUPLERS
ON ONE STAKE TO
**SUPPORT MORE
PLANTS**

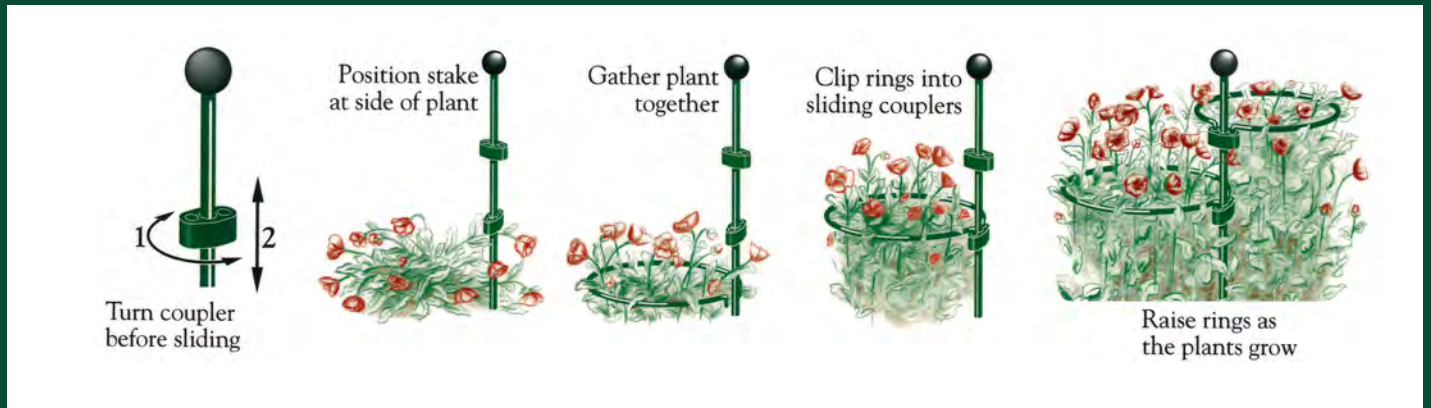

1 Classic Stake w/Coupler (Min 15 each)
• Made of 0.28" galvanized steel with vinyl sleeve

#PGS9101
30" (75cm) Classic



#PGS9102
40" (100cm) Classic



#PGS9103
50" (125cm) Classic



#PGS9104
60" (150cm) Classic



#PGS9105
70" (175cm) Classic

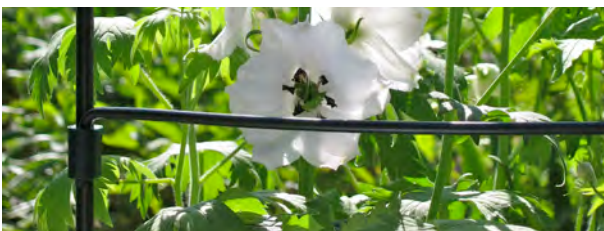

2 #PGS9400 (Min 10)
Standard Coupler (4-Pk)

- A unique attachment for securing support rings, grids, and borders to stakes
- The couplers allow the ring to be moved up and down, so the 'support' grows with the plant



4 #PGS9408 (Min 10)
6-Hole Coupler (2-Pk)

- Use the 6-Hole Coupler to create a full circle of rings with only one stake!



3 #PGS9407 (Min 10)
Twister Coupler (4-Pk)

- Add extra rings after the plant has already started to grow
- Easily clicks/twists on to the side of the stake, so the support can stay in the ground



5 #PGS9741
Peacock Info Leaflet (Qty 1)



CLASSIC RINGS, GRIDS & BORDERS

- Support rings and grids help hold plants in place.
- For delicate plants it is wise to use a support grid.



6 Side Support Rings (Min 15 each)

- With the various diameters available, you can use it for all types of plants
- Use the Twister coupler to attach multiple rings to the same stake

#PGS9210
2" (5cm) Side Support



#PGS9214
8" (22cm) Side Support



#PGS9211
4" (10cm) Side Support



#PGS9216
13" (32cm) Side Support



#PGS9212
6" (15cm) Side Support



#PGS9217
15" (38cm) Side Support



7 #PGS9230 (Min 15) 32" (81cm) 1/3 Circle Support Ring

- Supported by two stakes



8 Center Support Rings (Min 15 each)

- Holds plant steady from the middle
- Works great in flower boxes

#PGS9251
12" (30cm) Center Ring



#PGS9252
15" (40cm) Center Ring



SUPPORTS & GRIDS CONTINUED

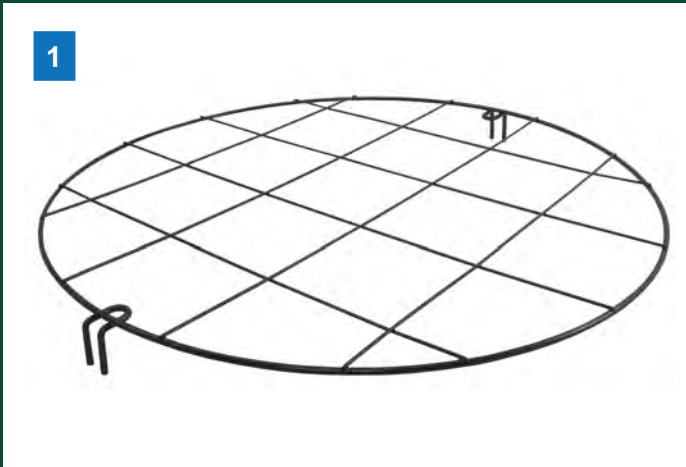

KEEP PLANTS BACK ALONG THE GARDEN PATH BY USING A STRAIGHT OR SCALLOPED BORDER EDGE.

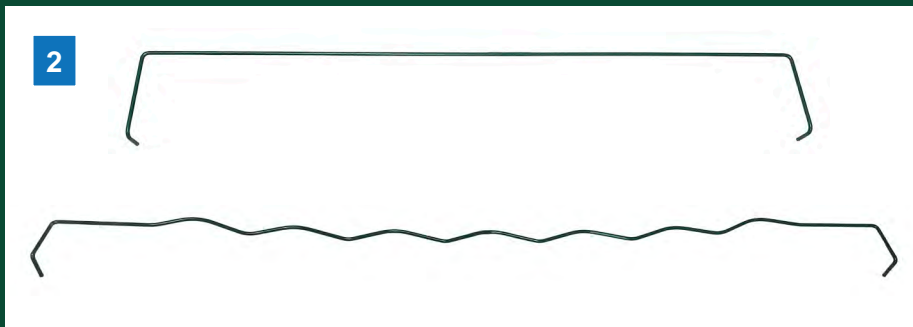

1 Round Support Grids (Min 15 each)

- For delicate plants, like Peonies, it is wise to use a support grid
- Place the grid over the plant at the beginning of the season and the plant will grow through
- Available in Standard or Center support

#PGS9284
16" (40cm) Round Grid



#PGS9285
20" (50cm) Round Grid



#PGS9286
24" (60cm) Round Grid



#PGS9291
12" (30cm) Round Center



#PGS9292
16" (40cm) Round Center



2 Border Edges (Min 15 each)

- Along the garden path, keeps plants back in an attractive manner

#PGS9261
32" (81cm) Straight



#PGS9273
40" (100cm) Scalloped



3 1/2 Circle Support Rings (Min 15 each)

- Great for supporting busy plants, such as Daisies
- Two 1/2 Circle Supports and two stakes will form a complete circle

#PGS9222
18" (45cm) 1/2 Circle



#PGS9223
21" (54cm) 1/2 Circle



#PGS9224
25" (64cm) 1/2 Circle



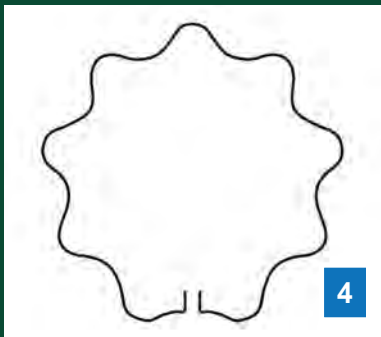

4

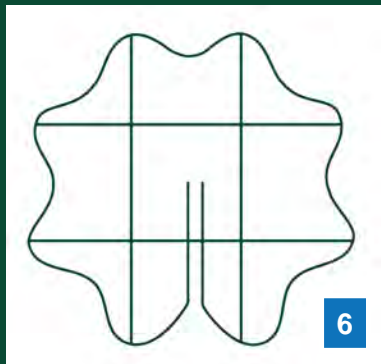

6

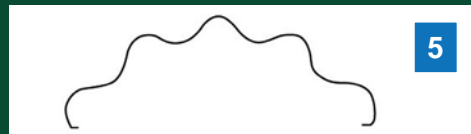

5

SCALLOPED RINGS KEEP FLOWERS FROM BUNCHING TOGETHER!

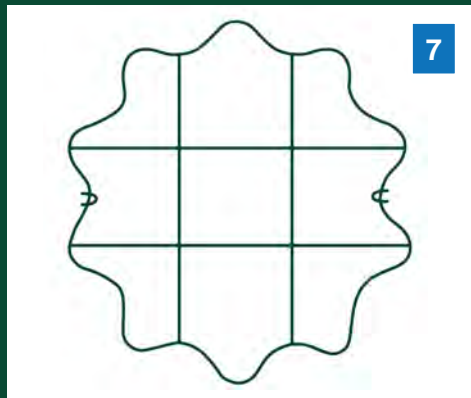

7

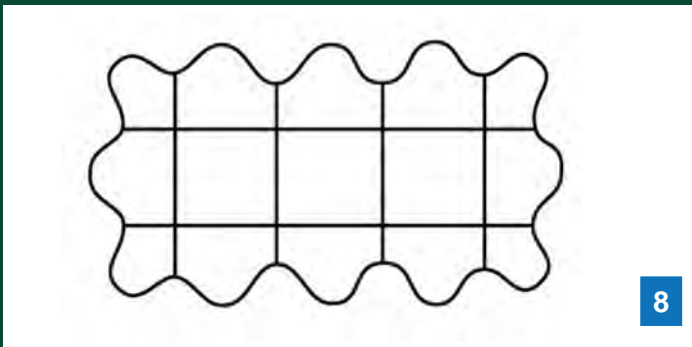

8

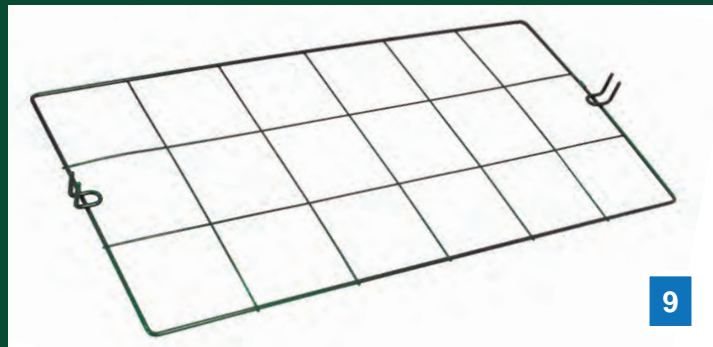

9

4 Scalloped Support Rings (Min 15 each)

- For support of top-heavy plants
- The scalloped design gives plants, like Peonies, more support, to grow more naturally

#PGS9219
13" (32cm) Scalloped



#PGS9220
19" (48cm) Scalloped



5 #PGS9225 (Min 15)
21" (54cm) 1/2 Circle Scalloped



Scalloped Support Grid (Min 5 each)

- For support of top-heavy plants
- Place the grid over the plant at the beginning of the season and the plant will grow through

6 #PGS9293
17" (43cm) Scalloped Grid with Center Support



7 #PGS9288
21" (54cm) Scalloped Grid



8 #PGS9287
26" (66cm) Rectangle Scalloped Grid



9 #PGS9283 (Min 5)
36" (91cm) Rectangle Grid

- For support of top-heavy plants
- Place the grid over the plant at the beginning of the season and the plant will grow through



VEGGIE STAKES

Veggie stakes make it easy to build a frame for peas or a plant spiral to encourage tomatoes to grow upwards. Use connector clips to fix the stakes together and plant ties to attach the stakes to plants.

- Durable alternative to bamboo sticks
- Made of galvanized metal
- Use connector clips to create frames or plant ties to secure plants to stakes



1 Veggie Stakes (Min 50 each)

#34-14101 24" (60cm) Veggie
0.35" Diameter



#34-14104 60" (150cm) Veggie
0.45" Diameter



#34-14102 36" (90cm) Veggie
0.35" Diameter



#34-14105 72" (180cm) Veggie
0.65" Diameter



#34-14103 48" (120cm) Veggie
0.45" Diameter



#34-14106 84" (210cm) Veggie
0.65" Diameter



2 #34-14305 (Min 10) 72" (180cm) Spiral Veggie Stakes

- Encourages tomatoes and other plants to grow up around the spiral
- Use the connector clips to create a frame



3 #34-14132 (Min 10 each) 0.4"D Connector (3-Pk)



**#34-14133
0.6"D Connector (3-Pk)**



4 #34-14150 (Min 10 each) 7" (18cm) Rubber Plant Ties (15-Pk)



**#34-14151
10" (25cm) Rubber Plant Ties (15-Pk)**



PEACOCK VEGGIE STAKE DISPLAY

- Veggie Stakes are made of a plastic-coated steel tube
- Extremely durable alternative to bamboo or cane stakes
- These provide a straight-forward means to build all the necessary frames for vegetable gardens when used in conjunction with the connectors
- The Spiral stake is ideal to grow cucumbers and tomatoes. Just place the Spiral stake over the seedlings and watch the plants grow up along the spiral!
- With the connection clips, you can simply connect various Spiral stakes together to create a 'wigwam' frame
- UV-Resistant!

#34-14003 Vegetable Stakes Display		
PART #	DESCRIPTION	QTY
#34-14101	Stakes, 24" (0.3"D)	50
#34-14102	Stakes, 36" (0.3"D)	100
#34-14103	Stakes, 48" (0.4"D)	100
#34-14104	Stakes, 60" (0.4"D)	100
#34-14105	Stakes, 72" (0.6"D)	25
#34-14106	Stakes, 84" (0.6"D)	25
#34-14132	Connector Clips - 3 Pack (0.4"D)	10
#34-14133	Connector Clips - 3 Pack (0.6"D)	10
#34-14150	Rubber Plant Ties, 7" - 15 Pack	10
#34-14151	Rubber Plant Ties, 10" - 15 Pack	10
#34-14305	Spiral Stakes, 72"	50
#34-11001D	Peacock Display Stand (1/2 price)*	1
#34-14003S	Display Header	1
		490
#34-14003POG Without display stand		

*display not available separately



#34-14003 Veggie Stakes Display
13.5"W x 20"D x 80"H



PEACOCK CLASSIC SUPPORT STAKE DISPLAY

- This display provides the best sellers in classic support stakes, along with couplers to attach rings, grids, and borders
- The support stake is the basis of the plant support and is available in 5 sizes on the display
- Each stake comes with one coupler and a rounded knob to protect eyes
- Individually packaged Standard and Twister Couplers also come on the display to build additional attachments
- Maximize selling opportunities by pairing with the #34-9009 Classic Rings, Grids, and Borders Display and/or #PGS9009-3 Scalloped Rings, Grids, and Borders Display

#34-9001 Peacock Classic Support Stakes & Couplers

PART #	DESCRIPTION	QTY
#PGS9101	Stakes, 30" high	45
#PGS9102	Stakes, 40" high	45
#PGS9103	Stakes, 50" high	45
#PGS9104	Stakes, 60" high	30
#PGS9105	Stakes, 70" high	30
#PGS9400	Standard Couplers (pack of 4)	20
#PGS9407	Twisters (pack of 4)	20
#PGS9741	Customer Leaflets	20
#34-9001D	Display Stand (1/2 Price)*	1
#PGS9096S	Display Header	1

235

#34-9001POG Without display stand

*display not available separately



#34-9001 Peacock Classic Support Stakes & Couplers
23"W x 24"D x 90"H



PEACOCK CLASSIC BEST SELLER DISPLAY

- A nice assortment of the most popular Classic Stakes, Support Rings, 1/2 Circles, and Center Supports, as well as couplers
- The perfect “starter” display for smaller Garden Centers
- Also great to use by checkout counters for last-second buys or outdoors next to perennials

#PGS9096 Peacock Classic Best Seller Display

PART #	DESCRIPTION	QTY
#PGS9101	Stakes, 30" high	30
#PGS9102	Stakes, 40" high	30
#PGS9103	Stakes, 50" high	30
#PGS9210	Side Support Rings 2" dia	15
#PGS9212	Side Support Rings 6" dia	15
#PGS9214	Side Support Rings 8" dia	15
#PGS9216	Side Support Rings 13" dia	15
#PGS9217	Side Support Rings 15" dia	15
#PGS9223	1/2 Round Support Rings 21" dia	15
#PGS9251	Center Support Rings 12" dia	15
#PGS9252	Center Support Rings 15" dia	15
#PGS9400	Support Couplers (pack of 4)	10
#PGS9407	Twisters (pack of 4)	10
#PGS9741	Customer Leaflets	20
#PGS9095D	Peacock Display Stand (1/2 Price)*	1
#PGS9096S	Display Header	1

230

#PGS9096POG *Without display stand*

*display not available separately



#PGS9096 Peacock Classic Best Seller Display
23"W x 24"D x 90"H



PEACOCK CLASSIC STAKE, SCALLOPED SUPPORT RING DISPLAY

- This display provides our best-selling Classic Stakes with an assortment of Scalloped Support Rings and Grids
- Perfect to pair with the #PGS9096 Classic Best Seller Display to provide customers with everything they need to support their plants

#PGS9009-1 Classic Stake & Scalloped Ring/Grid Display		
PART #	DESCRIPTION	QTY
#PGS9102	Stakes, 40" high	15
#PGS9103	Stakes, 50" high	30
#PGS9104	Stakes, 60" high	30
#PGS9219	Scalloped Support Rings - 13"	15
#PGS9220	Scalloped Support Rings - 19"	15
#PGS9225	1/2 Circle Scalloped Rings - 21"	15
#PGS9287	Rectangular Support Grids	10
#PGS9288	Circular Scalloped Support Grids - 21"	10
#PGS9293	Center Scalloped Support Grids - 17"	10
#PGS9407	Twisters (pack of 4)	20
#PGS9741	Customer Leaflets	20
#Module9009-1	Peacock Display Stand (1/2 price)*	1
#PGS9009S	Display Header	1
		170
#PGS9009-1POG Without display stand		

*display not available separately



#PGS9009-1 Peacock Scalloped Best Seller Display
23"W x 24"D x 90"H



PEACOCK CLASSIC RINGS, GRIDS, & BORDERS DISPLAY

- This display has the variety you need to outfit any garden and its many plants
- Easy for customers to select the size and shape of the support ring, grid, or border to best suit a variety of plants
- Pair with the Classic #34-9001 Peacock Classic Support Stakes Display
- Works well with #PGS9009-3 Scalloped Support Ring, Grid, and Border Display

#34-9009 Classic Rings, Grids & Borders Display

PART #	DESCRIPTION	QTY
#PGS9210	Side Support Rings 2" dia	15
#PGS9212	Side Support Rings 6" dia	15
#PGS9214	Side Support Rings 8" dia	30
#PGS9216	Side Support Rings 13" dia	30
#PGS9217	Side Support Rings 15" dia	30
#PGS9222	1/2 Round Support Rings 18" dia	30
#PGS9223	1/2 Round Support Rings 21" dia	30
#PGS9252	Center Support Rings 15" dia	30
#PGS9261	Straight Borders 32" length	15
#PGS9273	Scalloped Borders 40" length	15
#PGS9285	Grow Grids Round, 20" dia	10
#PGS9291	Grow Grids Centered 12" dia	10
#PGS9292	Grow Grids Centered 16" dia	10
#34-9009D	Display Stand (1/2 price)*	1
#34-9009S	Display Header	1
		270

#34-9009POG Without display stand

*display not available separately



#34-9009 Peacock Rings, Grids, & Borders
23"W x 24"D x 90"H

PLANT STAKES & SUPPORTS • PEACOCK



PEACOCK SCALLOPED SUPPORT RING, GRID & BORDER EDGE DISPLAY

- Provides a nice variety of Scalloped and Classic Support Rings, Grids, and Border Edges
- Pair with the Classic #34-9001 Peacock Classic Support Stakes Display

#PGS9009-3 Scalloped Ring/Grid and Border Display

PART #	DESCRIPTION	QTY
#PGS9210	Round Support Rings - 2"	15
#PGS9211	Round Support Rings - 4"	15
#PGS9212	Round Support Rings - 6"	15
#PGS9214	Round Support Rings - 8"	15
#PGS9216	Round Support Rings - 13"	15
#PGS9217	Round Support Rings - 15"	15
#PGS9219	Scalloped Support Rings - 13"	15
#PGS9220	Scalloped Support Rings - 19"	15
#PGS9222	1/2 Round Support Rings - 18"	15
#PGS9223	1/2 Round Support Rings - 21"	15
#PGS9225	1/2 Circle Scalloped Rings - 21"	15
#PGS9273	Scalloped Border Edges - 40"	15
#PGS9285	Round Growth Grids - 20"	10
#PGS9291	Round Center Grids - 12"	10
#PGS9293	Center Scalloped Support Grids - 17"	10
#Module9009-3	Peacock Display Stand (1/2 price)*	1
#PGS9009S	Display Header	1

210

#PGS9009-3POG *Without display stand*

*display not available separately



#PGS9009-3 Peacock Scalloped Support Ring & Grid and Border Edge Display
23"W x 24"D x 90"H



CLASSIC & SCALLOPED PLANT CRADLES

- Simply place in the ground to provide maximum support—14" Width
- One-piece design made from sturdy 0.24" galvanized steel with dark-green coating
- Choose from either the 1/2 Circle or the Scalloped 1/2 Circle Plant Support

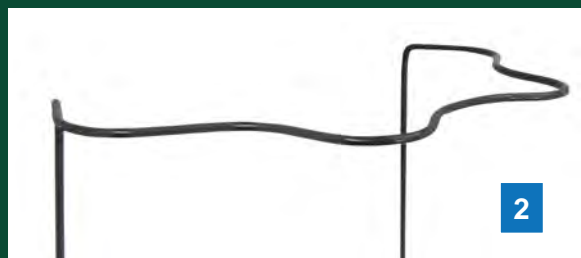

USE MULTIPLE PLANT SUPPORT COUPLERS TO CONNECT PLANT CRADLES TOGETHER PROVIDING GREATER STABILITY

1 Classic Plant Cradles (Min 10 each)

#PGS8130
14" (35cm) 1/2 Circle



#PGS8131
28" (70cm) 1/2 Circle



#PGS8132
40" (100cm) 1/2 Circle



2 Scalloped Plant Cradles (Min 10 each)

#PGS8240
14" (35cm) 1/2 Scalloped



#PGS8241
28" (70cm) 1/2 Scalloped



#PGS8242
40" (100cm) 1/2 Scalloped



3 #PGS8099 6mm (Min 10) Plant Cradle Couplers (4-Pk)



www.PeacockSupportsUSA.com

PEACOCK CLASSIC PLANT CRADLES

- Simply place in the ground to provide maximum support for your border and other plants
- One-piece design made from sturdy galvanized steel with dark-green coating. Won't rust and can stay outdoors all year long!
- 1/2 Circle Plant Support is available in three sizes: 14", 28", and 40" heights
- 14" Width

#PGS8000-2K Peacock 1/2 Circle Plant Cradles Display

PART #	DESCRIPTION	QTY
#PGS8130	1/2 Round Plant Cradle - 14"	100
#PGS8131	1/2 Round Plant Cradle - 28"	100
#PGS8132	1/2 Round Plant Cradle - 40"	100
#PGS8000-1D	Display Stand (1/2 Price)	1
#PGS8000S	Display Header	1
		300

#PGS8000-2KPOG Without display stand

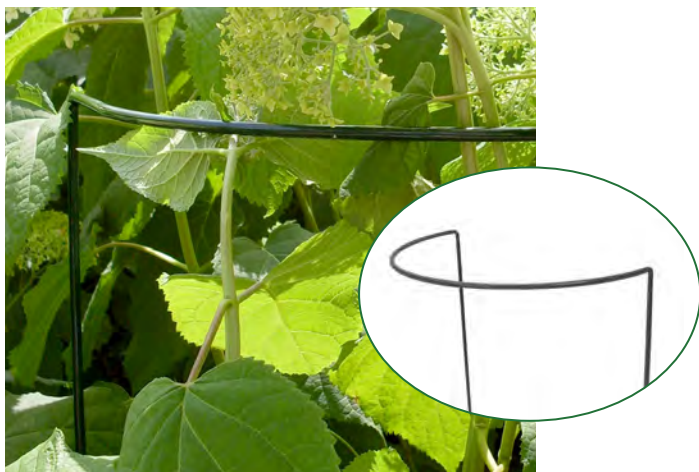

#PGS8099 6mm
Plant Cradle Couplers (4-Pk)

- Sold Separately



0 702633 080991



#PGS8000-2K Peacock 1/2 Circle
Plant Cradles Display

18.75"W x 29"D x 48"H

PEACOCK SCALLOPED PLANT CRADLES

- Simply place in the ground to provide maximum support for your border and other plants
- One-piece design made from sturdy galvanized steel with dark-green coating. Won't rust and can stay outdoors all year long!
- Scalloped 1/2 Circle Plant Support is available in three sizes: 14", 28", and 40" heights
- 14" Width



#PGS8000-1K Peacock Scalloped Plant Cradles Display		
PART #	DESCRIPTION	QTY
#PGS8240	Scalloped Plant Cradle - 14"	100
#PGS8241	Scalloped Plant Cradle - 28"	100
#PGS8242	Scalloped Plant Cradle - 40"	100
#PGS8000-1D	Display Stand (1/2 Price)	1
#PGS8000S	Display Header	1
		300
#PGS8000-1KPOG Without display stand		

* Display not available separately



#PGS8099 6mm
Plant Cradle Couplers (4-Pk)
• Sold Separately





#PGS8000-1K Peacock Scalloped
Plant Cradles Display
18.75"W x 29"D x 48"H

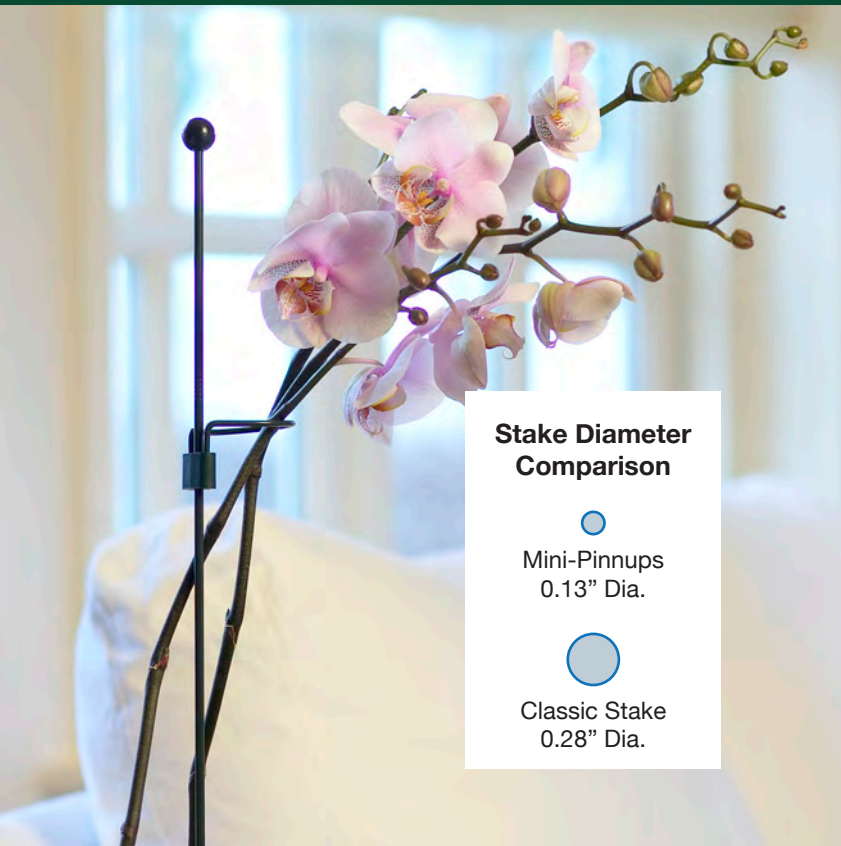



Stake Diameter Comparison

 Mini-Pinnups
 0.13" Dia.

 Classic Stake
 0.28" Dia.

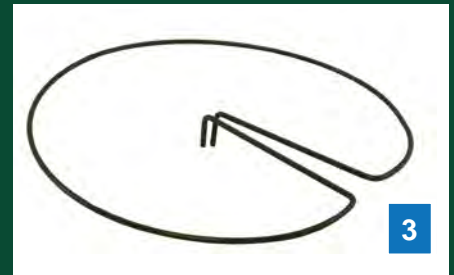

1 Mini Stake w/Coupler (Min 15 each)

- Made of .13" galvanized steel with vinyl sleeve

#PGS17101 16" (40cm) Mini



#PGS17102 20" (50cm) Mini



#PGS17103 24" (60cm) Mini



#PGS17104 30" (75cm) Mini



#PGS17105 36" (90cm) Mini



2 #PGS17400 (Min 10) **Mini Couplers (4-Pk)**



3 Mini Center Support Rings (Min 15 each)

- Much like our classic version, our mini version holds the plant steady from the middle

#PGS17250 6" (15cm) Mini Center



#PGS17251 8" (20cm) Mini Center



#PGS17252 10" (25cm) Mini Center



4 Mini Support Rings (Min 15 each)

- Because of the different diameters available, you can support a variety of plants

#PGS17210 2" (5cm) Mini Ring



#PGS17211 4" (10cm) Mini Ring



#PGS17212 6" (15cm) Mini Ring



#PGS17214 8" (20cm) Mini Ring



PEACOCK MINI SUPPORT STAKES & RINGS

- Perfect for container gardening and indoor plants
- Made of 0.13" galvanized steel with vinyl sleeve
- Will last a lifetime!
- Stakes have a safety knob for eye protection
- Works great for single-stem plants like orchids!

#PGS17000 Peacock Container Mini Plant Supports Display

PART #	DESCRIPTION	QTY
#PGS17101	Mini Stakes, 16" high	30
#PGS17102	Mini Stakes, 20" high	30
#PGS17103	Mini Stakes, 24" high	30
#PGS17104	Mini Stakes, 30" high	30
#PGS17105	Mini Stakes, 36" high	30
#PGS17210	Mini Support Ring, 2" dia.	15
#PGS17211	Mini Support Ring, 4" dia.	30
#PGS17212	Mini Support Ring, 6" dia.	30
#PGS17214	Mini Support Ring, 8" dia.	30
#PGS17250	Mini Center Support Ring 6" dia	15
#PGS17251	Mini Center Support Ring 8" dia	15
#PGS17252	Mini Center Support Ring 10" dia	30
#PGS17400	Mini Couplers (4 pack)	10
#PGS9741	Customer Leaflets	20
#PGS17000D	Peacock Display Stand (1/2 price)	1
#PGS17000S	Display Header	1
		325
#PGS17000POG Without display stand		

* Display not available separately



#PGS17000 Mini Plant Support Display
13.5"W x 20"D x 80"H

PLANT STAKES & SUPPORTS • PEACOCK



GARDEN STAKES



1 #11-1916 (Min 6) Tomato Cage Kit

- Kit includes three 58" metal stakes and nine 12" side bars
- Bamboo style covering with a green vinyl coating
- Easy to assemble, strong and reusable
- Build various shapes and sizes just by clicking the stakes together without damaging the plant
- Place sidebars where desired

12"L x 12"W x 58"H; 1lb



2 #11-1918 Side Bar

- 12" - Set of 10
- Works on 24", 36" & 48" Stakes



3 Garden Stakes (Min 20 each)

- Made of heat treated steel with a bamboo-style vinyl coating

#11-1911 24" Garden Stake

0.44"D



#11-1912 36" Garden Stake

0.44"D



#11-1913 48" Garden Stake

0.44"D



#11-1914 60" Garden Stake

0.625"D



#11-1915 72" Garden Stake

0.625"D



4 #11-1917 Garden Stake Display Stand

- Display stand comes complete with 250 total stakes - 50 of each of the 5 sizes

Display dimensions: 1'2"L x 1'2"W x 4'9"H



#11-1917 Garden Stake Display

PART #	DESCRIPTION	QTY
#11-1911	24" Stake	50
#11-1912	36" Stake	50
#11-1913	48" Stake	50
#11-1914	60" Stake	50
#11-1915	72" Stake	50
#11-1917D	Display Stand	1

250



GARDENING SOLUTIONS & PLANT PROTECTION

ROOTRAINERS™

- 'Air-Pruning' forms vigorous and strong roots
- Roots grow straight, allowing plants to establish quicker and avoids pot-bound plants
- Cells open like a book for easy removal of plugs & damage-free roots
- New green color for easier recycling
- The reusable cells snap together & tightly fit into the holding tray
- Can be used time and time again

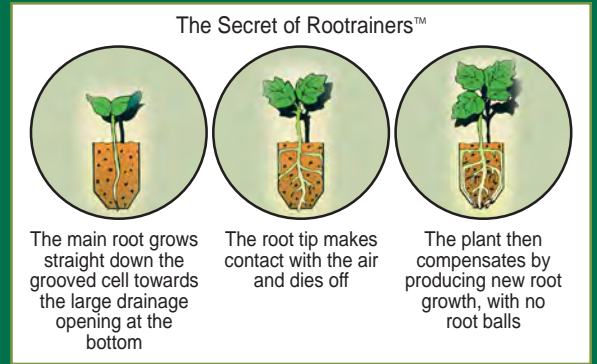

1 #50-9000 Deep Rootrainers

- 32 reusable cells in holding tray with lid
- 5" Deep
- Includes plastic lid to create a mini greenhouse

Product: 14.6"W x 8.7"D x 6.7"H; 1lb
Pack: 14.6"W x 8.7"D x 8.7"H Pack Size: 1



2 #50-9020 Rootrainer Racking Station

- The handy racking system, designed specifically for Rootrainers, is a must have for experienced seed sowers and the perfect starting point for complete novices
- The rack will hold 8 Deep Rootrainers
- Also suitable for holding seed trays and pots
- Keeping Rootrainers above ground enhances the unique air-pruning qualities and allows for easier access

Product: 32"W x 15"D x 29"H, 8.5lbs
Pack: 35"L x 16"D x 2.5"H Pack Size: 1



3 #50-9022 Rootrainer Kit

8 Deep Rootrainers and Rootrainer Racking Station



LEARN ABOUT THE BENEFITS OF ROOTRAINERS

SUNBUBBLES™

- Instant greenhouse made from UV-stabilized PVC and flexible fiberglass rods
- Easy to use, easy to move, easy to store
- Can be used as a seasonal greenhouse, outdoor dining, conservatory or playroom
- Unique, one piece, folding patented design
- Storage bag included
- Adjustable vents and a strong, zippered doorway



4 #50-2510 Large Sunbubble

- The curved shape of the Sunbubble means the surface stays 90 degrees to the direction of the sun all day long achieving minimum reflection and maximum penetration of light
- Features adjustable vents and a strong, zippered doorway
- Innovative dome design provides ample room for plants and greenhouse staging
- So versatile - use as a greenhouse, for parties, dining, camping, sunbathing, tailgating and outdoor playhouse
- Door dimensions: 27.5"W x 59"H

Product: 137.8"D x 86.6"H, 50lbs
Pack: 11.8"W x 11.8"D x 59"H Pack Size: 1



6 51609 21388 1

5 #50-2500 Standard Sunbubble

- The curved shape of the Sunbubble means the surface stays 90 degrees to the direction of the sun all day long achieving minimum reflection and maximum penetration of light
- Features adjustable vents and a strong, zippered doorway
- Innovative dome design provides ample room for plants and greenhouse staging
- So versatile - use as a greenhouse, for parties, dining, camping, sunbathing, tailgating and outdoor playhouse
- Door dimensions: 27.5"W x 55"H

Product: 110.2"D x 78"H, 33lbs
Pack: 9.8"W x 9.8"D x 55"H Pack Size: 1



6 51609 21387 4



VIEW THE SUNBUBBLE IN USE!

PATIO PLANTERS™

Patio Planters are perfect for small and urban gardens, patios, and balconies, they enable anyone to easily 'Grow Your Own' - the kids included. Made from green polyethylene, all of our planters have brass drainage holes around the sides and base, essential for satisfactory results!



- Made of tough polyethylene with reinforced drainage holes
- Can be reused



1 #50-1030 Vegetable Patio Planter

- Handles on each side
- Fold flat for easy storage
- Pack of 3 includes different depths - deep (10.5 gal), medium (9.2 gal) and shallow (9.2 gal) ideal for different types of vegetables

Product: 13.8"W x 17.7"H,
15.8"W x 11.8"H, 17.7"W x 9.8"H
Pack: 18.8"W x 21.7"H; 2lbs
Pack Size: 3



2 #50-1040 Potato/Tomato Patio Planter

- Handles on each side
- Fold flat for easy storage
- Holds about 10 gallons of compost and is suitable for potatoes or tomatoes
- Includes helpful growing guide

Product: 13.8"W x 17.7"H
Pack: 18.8"W x 21.7"H; 2lbs
Pack Size: 3



3 #50-1060 Strawberry/Herb Patio Planter

- Handles on each side
- Fold flat for easy storage
- Includes helpful growing guide
- Holds 11.9 gallons of compost

Product: 13.8"L x 17.7"W
Pack: 18.8"W x 21.7"H; 2lbs
Pack Size: 2



VIGOROOT™ POTS & PLANTERS

Vigoroot Pots and Planters are made from an advanced air-pruning fabric that creates a super-strong root system for healthier, more productive plants. Vigoroot Pots and Planters are suitable for a wide variety of herbs, vegetables and flowers, as well as strawberries and fruit bushes (blueberries). They work well on patios, in gardens, within decorative planters or containers, and for hydroponic gardening, and they enable anyone to easily "Grow Your Own."

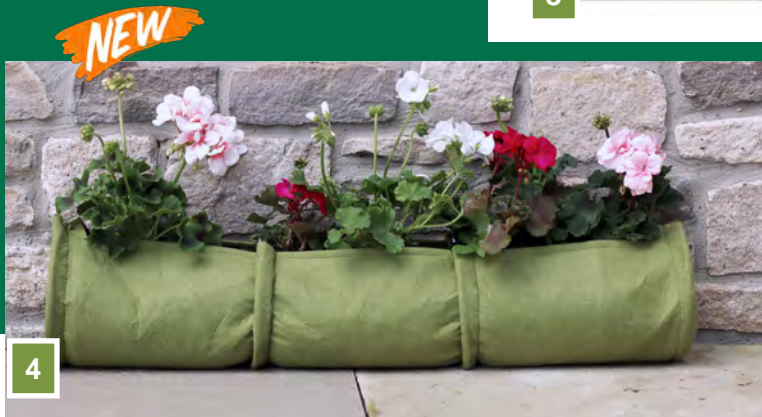

**4 #50-1603
Vigoroot Plant Tube**

- Long cylindrical shape for narrow spaces
- Reinforcing hoops keep circular shape

Product: 5.9"D x 29.5"L; 3.4 gallon
Pack: 7"W x 9"H x 1.6"D Pack Size: 1



NEW

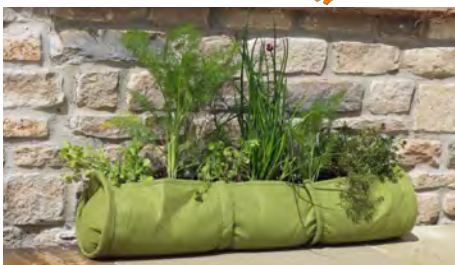

**5 #50-VIG09
10 Liter Vigoroot Pot**

Product: 9.5"D x 9.5"H; 2.27 gallon
Pack: 11"W x 14.1"H Pack Size: 3



**6 #50-VIG10
15 Liter Vigoroot Pot**

Product: 10.6"D x 10.6"H; 3.4 gallon
Pack: 11.4"W x 15"H Pack Size: 3



**7 #50-VIG11
20 Liter Vigoroot Pot**

Product: 12"D x 12"H; 4.54 gallon
Pack: 11.8"W x 15.7"H Pack Size: 3



**8 #50-VIG12
Tomato/Potato Planter**

Product: 13.8"D x 17.7"H; 10.6 gallon
Pack: 11.8"W x 15.7"H Pack Size: 1



**9 #50-VIG13
Vegetable Planter**

Product: 15.7"D x 11.8"H; 9.8 gallon
Pack: 11.8"W x 15.7"H Pack Size: 1



**10 #50-VIG14
Herb Planter**

Product: 17.7"D x 9.8"H; 10.6 gallon
Pack: 11.8"W x 15.7"H Pack Size: 1



HEMP FIBER POTS & PLANTERS™

NEW



- Made from 100% natural hemp fiber
- Compostable and biodegradable
- Can be planted directly into the ground
- Breathable fabric provides excellent drainage and aeration for healthy roots
- 9-12 months life

1



2



3



4



1

NEW

#50-1607 5L Hemp Fiber Pot

Product: 7.5"D x 7.5"H; 1.3 gallon
Pack: 6"W x 12"H x .75"D; .1lb
Pack Size: 1



2

NEW

#50-1608 20L Hemp Fiber Planter

Product: 12"D x 12"H; 5.3 gallon
Pack: 7"W x 10.5"H x .75"D; .1lb
Pack Size: 1



3

NEW

#50-1609 30L Hemp Fiber Planter

Product: 13.5"D x 13.5"H; 7.9 gallon
Pack: 9"W x 17.5"H x .75"D; .2lb
Pack Size: 1



4

NEW

#50-1610 40L Hemp Fiber Planter

Product: 14.5"D x 14.5"H; 10.6 gallon
Pack: 11.5"W x 22"H x .75"D; .3lb
Pack Size: 1



PREMIUM FABRIC MY FIRST VEGETABLE GARDEN/SANDPIT



HERB WALL PLANTER

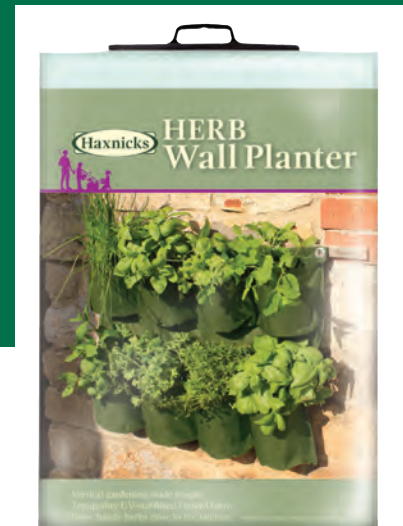

5 #50-8530 Premium Fabric My First Garden/Sandpit

- Made of high quality, UV-stabilized premium fabric for extra durability
- Sturdy, integral corner supports hold the planter in shape
- Can be used as a sandpit or a raised bed
- Perfect for growing all sorts of vegetables, fruits and herbs
- Get the kids involved with growing their own vegetables!
- Easy to follow instructions included
- Holds approximately 34 gallons of soil

Product: 31.5"W x 10"D; 2.2lbs
Pack: 9.8"W x 33.5"H x 1.5"D
Pack Size: 1



6 51609 21457 4



6 #50-1070 Herb Wall Planter

- Hanging planter made from top quality UV-stabilized PVC premium fabric with 8 planting pockets
- Reinforced eyelets and mounting hooks
- The lightweight planter can be suspended on fences and walls using standard screws or hooks
- Folds down for easy storage
- Substantially increases planting area in small gardens, patios and balconies
- Vertical gardening made simple!

Product: 23.6"W x 18.9"H Pocket: 6"W x 6"D x 9"L
Pack: 9.8"W x 11.8"H x .5"D; 1lb Pack Size: 1



6 51609 21433 8

URBAN GARDENING

LIGHT-BOOSTERS

Reflective backing bounces light back onto the plants, increasing light levels by up to 70%, boosting plant growth and giving healthier, more robust plants



1



2

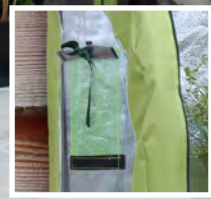

1 # 50-1470 Tomato Crop Booster with Cover

- Innovative design with patented (Tenderbrace™) support system which fully supports plants, leading to higher yields
- Easy to adjust 'slide & clip' design
- Suitable for use with pots, growbags or plants in the ground
- Cover is clear UV stabilized PVC with tough premium fabric reinforced edges.
- Fully open front can be rolled up for easy access
- Vents on side with fine netting

Product: 40"W x 64"H x 20"D, 5.2 lb
Pack: 40"W x 10"H x 3"D Pack Size: 1



Light-Booster Plant Houses

- Ideal for growing a wide variety of plants in pots and seed trays
- Grow vegetables, herbs, fruit and flowers
- Extra light boosts plant growth
- Protects plants from frost and harsh weather
- Double zipped door provides easy access to the plants inside
- Side vents covered in Micromesh prevent overheating

2 #50-1600 Double Plant House

- 4 full height zippers allowing the front 2 panels to be rolled up

Product: 59"W x 63"H x 15.7"D; 17.6lb
Pack: 17"W x 31"H x 3.5"D Pack Size: 1



3 #50-1601 Single Plant House

- 2 full height zippers allowing the front panel to be rolled up

Product: 29.5"W x 63"H x 15.7"D; 10.6lb
Pack: 17"W x 31"H x 2"D Pack Size: 1



VIGOROOT™ BALCONY GARDEN

The Vigoroot Balcony Garden is a convenient growing system for small gardens, roof terraces, patios and balconies, allowing the maximum number of plants in a small space. The Vigoroot fabric troughs allow the plants to air prune producing a healthier root system.



3



5



4



6

4 # 50-1602 Light-Booster Cold Frame

- Ideal for growing a wide variety of plants in pots and seed trays
- Grow vegetables, herbs, fruit and flowers
- Extra light boosts plant growth
- Protects plants from frost and harsh weather
- Double zipped door provides easy access to the plants inside
- Side vents covered in Micromesh prevent over heating

Product: 39.3"W x 19.7"H x 19.7"D; 3.3lb
Pack: 8"W x 38.5"H x 2"D Pack Size: 1



6 51609 21570 0

NEW

5 #50-VIG150 Vigoroot Easy Table Garden

- Vigoroot fabric table planter with integral self-watering system and polyethylene protective cover
- Hidden water reservoir waters plants via capillary action
- Air pruning fabric for healthy roots and excellent drainage
- Two deep planting troughs allow plenty of room for a wide variety of container vegetables and herbs
- Removable poly protective cover with built-in side vents
- No pipes, tubes or electric required!
- An easily accessible growing system for small gardens, patios and balconies
- A raised bed, greenhouse and irrigation system all rolled into one!

Product: 31.5"W x 43.4"H x 13"D; 9lbs
Pack: 13.7"W x 33.5"H x 3.5"D Pack Size: 1
Troughs Size: 31.5"W x 9.5"D



6 51609 21436 9

6 #50-1467 Vigoroot Balcony Garden

- Vigoroot fabric multi-tier planter with air pruning fabric for healthy roots and excellent drainage
- Ideal for those who really want to grow their own veggies but do not have a lot of space
- Four, deep planting troughs (31.5" W x 9.5" Deep) allow a wide variety of container veggies, salads and herbs to be grown on a balcony or small corner of the garden, vastly increasing productive space

Product: 31.5"W x 9.5"D x 63"H; 10.5lbs
Pack: 10"L x 4"D x 2' 9"H Pack Size: 1



6 51609 21467 3

EASY TUNNELS™

The original and best selling tunnel cloche incorporating Haxnicks' patented designs. Haxnicks offers the most complete range of tunnel cloches in four different long-lasting materials for year round protection. Poly, Fleece, Micromesh, and Net are available in both giant and standard sizes.



POLY TUNNELS

- Warms soil enabling earlier planting
- Forms a complete barrier retaining warmth and humidity
- Protects against harsh weather, animals, and pests
- Made from UV-stabilized, 150 micron heavy-duty polyethylene, and rust-proof galvanized steel hoops

1 #50-5000 Giant Easy Poly Tunnel

Product: 118"L x 24"W x 18"H; 4.3lbs
Pack: 29.5"W x 25.6"H Pack Size: 1



2 #50-5050 Easy Poly Tunnel

Product: 118"L x 18"W x 12"H; 2.3lbs
Pack: 19.7"W x 23.6"H Pack Size: 1



FLEECE TUNNELS

- Creates warmth and insulation while allowing air, moisture, and sunlight to filter through
- Forms a complete barrier against frost and harsh weather, animals, and pests
- Made from UV-stabilized, 45gsm heavy-weight polypropylene fleece, and rust-proof galvanized steel hoops

3 #50-5010 Giant Easy Fleece Tunnel

Product: 118"L x 24"W x 18"H; 3lbs
Pack: 29.5"W x 25.6"H Pack Size: 1



4 #50-5060 Easy Fleece Tunnel

Product: 118"L x 18"W x 12"H; 1.75lbs
Pack: 19.7"W x 23.6"H Pack Size: 1



NET TUNNELS

- Provides shade against strong sunlight
- Conserves moisture
- Protects from insects, birds, and animals
- Made from UV-stabilized, high-density 5mm mesh polyethylene, and rust-proof galvanized steel hoops

5 #50-5020 Giant Easy Net Tunnel

Product: 118"L x 24"W x 18"H; 4lbs
Pack: 29.5"W x 25.6"H Pack Size: 1



6 #50-5070 Easy Net Tunnel

Product: 118"L x 18"W x 12"H; 2.1lbs
Pack: 19.7"W x 23.6"H Pack Size: 1



EASY SEEDLING TUNNELS

All the benefits of our larger Easy Tunnels™, but in a miniature size! The Easy Seedling Tunnel makes for an inexpensive way to maximize sowing success. Seeds are far more likely to germinate and grow healthily in a warm, moist environment protected from birds and other pests.



MICROMESH™ TUNNELS

- Ultra-fine mesh forms an ULTIMATE barrier against insects, birds, animals, and frost
- Allows air and water to pass through easily, while green tint provides shade and retains moisture
- Made from UV-stabilized, high-density 0.6mm fine mesh polyethylene, and rust-proof galvanized steel hoops

7 #50-5030 Giant Easy Micromesh Tunnel

Product: 118"L x 24"W x 18"H; 3.5lbs
Pack: 29.5"W x 25.6"H Pack Size: 1



8 #50-5040 Easy Micromesh Tunnel

Product: 118"L x 18"W x 12"H; 1.8lbs
Pack: 19.7"W x 23.6"H Pack Size: 1



EASY SEEDLING TUNNELS

- Made from UV-stabilized, heavy duty polyethylene and rust-proof galvanized steel hoops
- Protects seedlings from harsh weather and pests
- Provides cozy moist microclimate for germination and rapid seedling growth
- No pegs required!
- 3 pack

9 #50-5080 Easy Seedling Tunnels

Product: 31.5"L x 7"W x 4.7"H
Pack: 10"W x 13.4"H Pack Size: 3



KITCHEN GARDEN CLOCHE



Garden News
BEST BUY



1 #50-6000 Kitchen Garden Cloche

- Sturdy, high-quality, long-lasting and stylish grow cover
- Perfect for the “Grow Your Own” gardener looking to add a touch of elegance to the kitchen garden
- Made from galvanized and black powder-coated steel with high quality, UV-resistant clear plastic (APET), this is the “Rolls Royce” of garden cloches
- Easy to use with an ornate carry handle
- Generous height for larger plants
- Adjustable air vents
- Includes galvanized steel ground pegs

Product: 39.4”L x 17.7”W x 13.8”H; 5.5lbs
Pack: 39.4”W x 4.3”D x 17.3”H Pack Size: 1



MICROMESH PROTECTIVE BLANKETS

- Micromesh Blankets provide the ultimate organic solution for protecting your growing crops from pests and insects
- The ultra-fine mesh is only 0.6mm, which is small enough to keep out cabbage root flies, carrot flies, white flies, flea beetles, aphids, and other insects
- Forms a barrier against birds, animals, and frosts while still allowing sunlight, watering, and access to crops
- Green tint provides shade and retains moisture
- #50-7000 can be cut to size!
- Pre-cut Blankets come with fabric loops; use Haxnicks Ground Pegs to secure (#50-2000, 12-pack)



EXTRA THICK FLEECE BLANKET

Protect your plants from frost and harsh weather with the Extra Thick Fleece Blanket made from 35 gsm fleece fabric that creates and retains warmth. The fabric allows air, moisture and sunlight to filter through, meaning no need to remove for watering. The soft green tint provides shade and blends in well with the natural surroundings.



HAXNICKS' ULTRA-FINE MICROMESH FABRIC IS THE BEST KNOWN, FINEST GAUGE PROTECTION FABRIC AVAILABLE

2 #50-7000 Micromesh Blanket

Product: 198"L x 69.6"W; 1.5lb
Pack: 13.5"W x 19"H Pack Size: 1



3 #50-3500 8' Pre-Cut Micromesh Blanket

Product: 96"W x 96"H; 1lb 16 fabric loops
Pack: 10"W x 14"H Pack Size: 1



4 #50-3510 12' Pre-Cut Micromesh Blanket

Product: 144"W x 144"H; 1.2lb 24 fabric loops
Pack: 12.5"W x 19"H Pack Size: 1



5 #50-3520 16' Pre-Cut Micromesh Blanket

Product: 192"L x 192"W; 3lbs 32 fabric loops
Pack: 14.5"L x 19"W Pack Size: 1



Use Ground Pegs (sold separately)

6 #50-2000 Ground Pegs (12-Pk)

Product: 6.3"L; 0.25lbs
Pack: 3.2"W x 9.5"H Pack Size: 12



7 #50-1064 Extra Thick Fleece Blanket

- Extra thick 35 gsm fabric creates and retains warmth
- Protects against frosts, harsh weather, birds, animals and insects
- Allows air, moisture and sunlight to filter through, no need to remove it for watering
- Pre-warms soil, prior to planting, to extend growing season by up to 6 weeks
- Use with ground pegs (sold separately)

Product: 5'11"W x 32'8"L; 2lbs
Pack: 1.2"W x 1'8"H Pack Size: 1



1



2



3



4



VICTORIAN BELL CLOCHES

The original and best selling Bell Cloche range, incorporating Haxnicks' registered designs. Pleasing appearance of original glass bell jars with sturdy and practical vent tops. Made from high-quality vacuum-formed APET, they are perfect for vegetable plots and flower beds, and will promote quick, stable, and healthy new growth.

1

#50-1110 Baby Victorian Bell (3-Pk)

Product: 9.8"D x 7.9"H; 0.5lbs
Pack: 9.8"D x 10.6"H Pack Size: 3



3

#50-1130 King Size Bells (2-Pk)

Product: 15"D x 12"H, 1.8lbs
Pack: 15"D x 13"H Pack Size: 2



2

#50-1100 Original Victorian Bell (3-Pk)

Product: 13.4"D x 10"H; 1lb
Pack: 13.4"D x 13"H Pack Size: 3



4

#50-2000 Ground Pegs (12-Pk)

Product: 6.3"L; 0.25lbs
Pack: 3.2"W x 9.5"H Pack Size: 12





5



6

MICROMESH PEST & WIND BARRIER

Protect vegetables from carrot flies and other insects and pests, while effectively blocking the wind

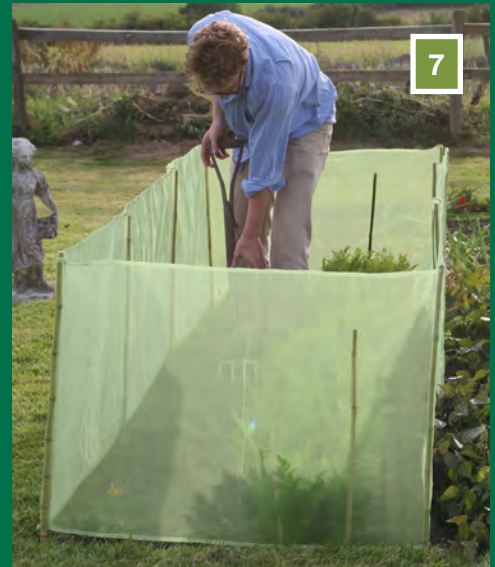

7

5 Micromesh Tomato Tubes

- Organic pest and weather protection sleeve with ultra-fine 0.6mm Micromesh netting
- Can be supported with canes (not included) and secured at top with wire ties (included)
- Available in single or triple pack

#50-7500 Pack of 1

Product: 6' 7"L x 1' 11.5"D; 0.75lb
Pack: 11.8"W x 1.2"D x 16.5"H Pack Size: 1



6 51609 21450 5



#50-7510 Pack of 3

Product: 6' 7"L x 1' 11.5"D
Pack: 11.8"W x 3.1"D x 16.5"H Pack Size: 3

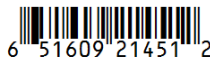

6 51609 21451 2

6 #50-6070 Twist-Up Tomato Cloche

- Protects tomatoes and other tall plants against blight, slugs, and harsh weather
- Pops up quickly and folds down neatly
- Enables earlier planting!
- Pairs well with Tomato Patio Planter™

Product: 19"D x 43"H, 1.75lbs
Pack: 20.5"W x 0.5"D x 20.5"H Pack Size: 1



6 51609 21315 7

7 #50-4000 Micromesh Pest & Wind Barrier

- Tightly woven ultra-fine 0.6mm mesh with integral bamboo supports allows sunlight, watering, and easy access to crops
- Pack of 2, which protects over 26' total
- Adaptable to surround various shaped plots

Product: 157"L x 27.6"W; 2lbs
Pack: 9"W x 3.1"D x 39.4"H Pack Size: 2



6 51609 21306 5



FRUIT TREE COVERS

Most fruit trees are very hardy but with new growth in the spring, flowers and buds are especially vulnerable to frost and may need protection to crop well. Heavy rain and hail can also be damaging to both flowers and fruits.

The 1mm (0.04") mesh size of the Haxnicks Fruit Tree Covers is large enough to let in moisture and sunlight but protects from harsh rainfall and hail. It is also small enough to avoid trapping birds, bats and other unsuspecting wildlife.

It is important to uncover fruit trees once the flowers are set to allow access for pollinating insects.

- Easy to use "Lift Over" design
- Wildlife friendly 1mm (0.04") mesh in soft green
- Sealable, drawstring opening
- Protects fruit from cherry worm, aphids, fruit fly, wasps, birds, and other pests without the need for chemical sprays
- Protects from frost, heavy rain, and hail
- Use in the early Spring to protect blossoms and then remove for pollination
- Use in summer and autumn to protect fruits
- Perfect for cherry, peach, nectarine, apricot, apple, pear trees and more!



**1 #50-1604
3.3' Fruit Protection Net**

Product: 3.3'D x 5'H; 3lbs
Pack: 11.8"W x 3"D x 15"H
Pack Size: 1



**2 #50-3530
6.6' Fruit Tree Cover**

Product: 6.6'D x 6.6'H; 5lbs
Pack: 18.1"W x 3.5"D x 22"H
Pack Size: 1



**3 #50-3540
9.8' Fruit Tree Cover**

Product: 9.8'D x 9.8'H; 10lbs
Pack: 19.3"W x 5.9"D x 23.6"H
Pack Size: 1



**4 #50-3550
13.1' Fruit Tree Cover**

Product: 13.1'D x 13.1'H; 16lbs
Pack: 22.4"W x 7.9"D x 27.2"H
Pack Size: 1



CHECK OUT
THESE FRUIT
TREE COVER
INSTALLATION
TIPS



EASY FLEECE JACKETS

Provide instant protection from frost and harsh weather, and still allow air and moisture to filter through, maintaining healthy growth. Manufactured from soft-green, high quality U.V.-stabilized, extra-thick 35gsm (grams per square meter) polypropylene fleece, with integral drawstring for easy and practical use.



5 #50-8020 Small Fleece Jacket (4-Pk)

- For wintering small plants in containers and protecting against sudden frosts

Product: 23.6"W x 31.5"H; 0.5lbs
Pack: 9.5"W x 15.4"H Pack Size: 4



6 #50-8010 Medium Fleece Jacket (3-Pk)

- Protects hanging baskets and medium-sized plants from early or late frosts

Product: 31.5"W x 39.4"H; 0.5lbs
Pack: 9.5"W x 15.4"H Pack Size: 3



7 #50-8000 Large Fleece Jacket (2-Pk)

- Ideal cover for wintering large, exotic and tender container plants (e.g., palms, cordalynes, etc)

Product: 47.2"W x 70.9"H; 1lb
Pack: 9.5"W x 15.4"H Pack Size: 2



ORIGINAL SOFT-TIES™

Soft-Tie is a fast selling, multi-purpose garden tie designed and developed by Haxnicks, manufactured from a unique UV-stabilized rubber compound around a rust-proof galvanized steel core. The soft green and woody colors complement plants and stakes perfectly. Long lasting, strong, easy to cut and bend, it will retain its shape and can be used time and again.



Garden Answers
 “Kind to tender plant stems”



1



- 1 #50-1520 Fold-A-Frame**
- Elegant and versatile plant support frame with 4 steel hinged panels
 - Units can be clipped together in various configurations to use in all types of gardens

Product: 13"W x 43"H;
 0.7lbs per panel
 Pack: 13"W x 1"D x 43"H Pack Size: 1



Original Soft-Tie:
 Ideal tree ties, supporting climbing roses and heavy branches, and for training fruit

Slim Soft-Tie:
 Ideal for delicate plant stems like tomatoes, assembling cane and willow structures, and general garden use

SEE THE MANY USES FOR SOFT-TIE AROUND THE HOUSE AND GARDEN!



- 2 #50-3000 Original Soft-Tie Green**
 5m Roll; chunky 7mm (0.28") diameter
 Product: 197"L x 0.3"W; 0.5lbs
 Pack: 3.9"W x 7.9"H Pack Size: 1



- 4 #50-3020 Original Soft-Tie Woody**
 5m Roll; chunky 7mm (0.28") diameter
 Product: 197"L x 0.3"W; 0.5lbs
 Pack: 3.9"W x 7.9"H Pack Size: 1



- 3 #50-3010 Slim Soft-Tie Green**
 8m Roll; chunky 3.5mm (0.14") diameter
 Product: 315"L x 0.14"W; 0.5lbs
 Pack: 3.9"W x 7.9"H Pack Size: 1



- 5 #50-3030 Slim Soft-Tie Woody**
 8m Roll; chunky 3.5mm (0.14") diameter
 Product: 315"L x 0.14"W; 0.5lbs
 Pack: 3.9"W x 7.9"H Pack Size: 1





6

COCO TREE MATS

SUPPRESS WEEDS AND HELP RETAIN MOISTURE



7

Grow It!
Composting has never been quicker, easier and more fun!



- 6 Coco Tree Mat**
- Biodegradable mulch mats made from organic coconut fibers
 - Suppress weeds around young trees
 - Prevents the need to trim close to vulnerable tree trunks
 - Allows water, air and nutrients to reach roots
 - Helps retain moisture in early stages of growth of newly planted trees
 - Available in three sizes

#50-9500 Round Coco 8" Tree Mat
Product: 8"D; 0.1lb
Pack Size: 8"W x 9"H Pack Size: 3



#50-9510 Round Coco 12" Tree Mat
Product: 12"D; 0.2lb
Pack: 12"W x 13"H Pack Size: 3



#50-9520 Round Coco 16" Tree Mat
Product: 16"D; 0.3lb
Pack: 16"W x 17"H Pack Size: 3



- 7 #50-1500 Rollmix Composter**
- Home composting has never been easier, quicker or more fun!
 - The polyethylene fabric traps heat, and by adding water and rolling, it is possible to make your own compost in 6 weeks
 - Perfect if you are living in a rental property or have limited space
 - Folds flat for easy storage
- Product: 26"L x 22"D, 2.6lbs
Pack: 22.5"W x 1.5"D x 22.5"H
Pack Size: 1



HAXNICKS ROLLMIX COMPOSTER QUICK TIPS!

GROWLITE COIR DISCS

- Peat-Free multi-use coir based growing medium that replaces compost
- Premium formula mix, with added nutrients, for faster growth & healthier plants
- Tried and tested by commercial growers
- Ideal for small space growers and indoor growers as it is easy to store and handle
- Perfect for pots, planters, hanging baskets and hydroponics
- Carefully controlled PH and EC levels guarantee suitability for a wide variety of plants
- Sustainable alternative to peat based compost
- Cleaner and more hygenic



1 #50-1605 GrowLite Coir 100g Discs - 10 pack

- Peat-Free multi-use coir based growing medium
- Premium formula mix, with added nutrients, for faster growth & healthier plants
- Add 1 gallon of water to make 3.2 gallons of growing medium

Product: 3.9"D x .8"H; 0.5lb
Pack: 3.9"D x 9"H



6 51609 21554 0



2 #50-1606 GrowLite Coir 20g Discs - 10 pack

- Peat-Free multi-use coir based growing medium
- Premium formula mix, with added nutrients, for faster growth & healthier plants
- Add 24oz of water to make .63 gallons of growing medium

Product: 2.4"D x .5"H; 2.5lb
Pack: 2.4"D x 4.7"H



6 51609 21555 7



BAMBOO POTS AND SAUCERS

All products are made from sustainable bamboo fiber and rice starch. This material is free from petroleum-based plastics and BPA. Will last for 5+ years indoors or out, making them a great alternative to single use pots and trays. They are also biodegradable and will compost in 6-12 months. Perfect for growing herbs on a window sill or filling your greenhouse!



BPA FREE!
MADE FROM SUSTAINABLE BAMBOO & RICE



**3 #50-1452
 4" Green Bamboo Pot (5 Pack)**

Product: 4"W x 4"H; 1.25lbs
 Pack: 4"W x 6"H Pack Size: 5



NEW

**4 #50-1462
 6" Green Bamboo Pot (5 Pack)**

Product: 6"W x 6"H; 2lbs
 Pack: 6"W x 8"H Pack Size: 5



**5 #50-1450
 8" Green Bamboo Pot (single)**

Product: 8"W x 8"H; 2lbs
 Pack Size: 1



NEW

Green Bamboo Pots & Saucers

- Made from sustainable bamboo, rice starch and resin made from naturally occurring organic compounds
- Indoor or outdoor use
- Reusable 5+ years
- Free from petroleum-based plastics and BPA
- Biodegradable and will compost in 6-12 months
- Breaking the products into small pieces before adding them to your compost heap will help speed up this process

**6 #50-1453
 4" Bamboo Saucer (5 Pack)**

Product: 3"W x 0.9"H; 0.7lbs
 Pack: 3"W x 1.5"H Pack Size: 5



NEW

**7 #50-1464
 6" Bamboo Saucer (5 Pack)**

Product: 6"W x .9"H; 1lb
 Pack: 6"W x 1.5"H Pack Size: 5



**8 #50-1451
 8" Bamboo Saucer (single)**

Product: 8"W x 1"H; 1lb
 Pack Size: 1



NEW

BAMBOO SEED TRAY AND GROWING MAT



- 1 # 50-9600**
Microgreens Growing Mat (3 Pk)
- Made from coir fiber with natural latex
 - Designed to fit Haxnicks Bamboo Seed Tray or cut to any size
 - Biodegradable and compostable
 - Natural, contemporary and plastic-free way to grow your own organic food
 - Seeds not included

Product: 13"L x 7.1"W x .08"H; 0.2lbs
 Pack: 13"L x 7.1"W x .25"H
 Pack Size: 3



6 51609 21526 7

- 2 #50-1466**
Bamboo Seed Tray
- Made of sustainable bamboo and rice
 - Reusable 5+ years
 - Free from petroleum-based plastics and BPA
 - Biodegradable and will compost in 6-12 months
- Product: 14.5"L x 8.3"W x 2.1D; 1.3lbs
 Pack: 14.5"L x 8.3"W x 2.1D
 Pack Size: 1



6 51609 21466 6



HAXNICKS BAMBOO DISPLAY

All products are made from sustainable bamboo fiber and rice starch. Will last for 5+ years indoors or out, making them a great alternative to single use pots and trays. They are also biodegradable and will compost in 6-12 months.

NEW



#50-1400 Haxnicks Bamboo Display		
Part #	Description	QTY
Shelf 1		
#50-1452	4" Green Bamboo Pot 5 Pack	18
#50-1453	4" Green Bamboo Saucer 5 Pack	18
Shelf 2		
#50-1462	6" Green Bamboo Pot 5 Pack	12
#50-1464	6" Green Bamboo Saucer 5 Pack	12
Shelf 3		
#50-1450	8" Green Bamboo Pot Single	20
#50-1451	8" Green Bamboo Saucer Single	20
Shelf 4		
#50-9600	Microgreens Growing Mat 3-Pack	20
#50-1466	Bamboo Seed Tray	20
Shelf 5		
#50-1605	Coir 100g Disc, 10 Pack - Growlite Premium	20
#50-1606	Coir 20g Disc, 10 Pack - Growlite Premium	20
#3-DISPLAY	Display only	
		180
#50-1400POG	Without display stand	

BPA FREE!
MADE FROM
SUSTAINABLE
BAMBOO
& RICE



#50-1400
Haxnicks Bamboo Display
25"W x 16.5"D x 62"H

VIGOROOT HANGING BASKET LINERS

HANGING BASKET LINERS MADE FROM VIGOROOT AIR PRUNING FABRIC GIVING MORE ABUNDANT FLOWERS AND LONGER LASTING BLOOMS

- Vigoroot promotes rapid root growth giving stronger roots
- Stronger roots allow plants to absorb more nutrients and grow larger

Vigoroot Hanging Basket liners are made from Air Pruning fabric to give more abundant plants. Not only will it act as a very effective barrier to keep soil and plants in place but it will also make the plants develop much healthier root systems.

There are many different liners on the market but none of them specifically aims to provide air pruning to ensure bigger blooms that look better for longer. Being a more solid material than coir or moss liners, it will not be targeted by birds trying to steal nesting material.

Washable at the end of the season—they can be reused year after year.



Vigoroot Hanging Basket Liners

1 #50-VIG200 12" Liner

Pack: 9"L x .4"H x 9"W; 0.3lbs
Pack Size: 1



6 51609 21527 4



2 #50-VIG210 14" Liner

Pack: 10"L x .4"H x 10"W; 0.4lbs
Pack Size: 1



6 51609 21528 1



3 #50-VIG220 16" Liner

Pack: 12"L x .4"H x 12"W; 0.5lbs
Pack Size: 1



6 51609 21529 8



AQUASTORE

WATER STORAGE FOR HANGING BASKETS



- AquaStore Hanging basket liners store water for plants to draw up steadily
- It means people need to water less frequently
- Keeps plants hydrated for longer
- Made from super absorbent polymer crystals
- Can be used in conjunction with Vigoroot Hanging Basket Liners

AquaStore absorbs water in the super absorbent polymer crystals. It then gently releases the water back to the plant exactly when required. Plants are healthiest when they can get water as and when they need it. So not only does using AquaStore mean less frequent watering but it also means no more over or under watering, resulting in happy plants.

AquaStores do not replace traditional liners as they are placed within the soil rather than on the outside.



AquaStore — water storage for hanging baskets

4 #50-9800
12" AquaStore, fits 12" basket
 • Holds 8 oz of water
 Pack: 6"L x .4"H x 9"W; 0.1lbs Pack Size: 1



5 #50-9810
14" AquaStore, fits 14" basket
 • Holds 11oz of water
 Pack: 7"L x .4"H x 10"W; 0.1lbs Pack Size: 1



6 #50-9820
16" AquaStore, fits 16" basket
 • Holds 14 oz of water
 Pack: 8"L x .4"H x 12"W; 0.2lbs Pack Size: 1



GARDEN ARCH

- Arch is a majestic 8.5' high!
- Gate height: 35.5"
- Strong, 1-1/4" tubular steel
- Black polyester powder coating
- Four ground anchors included
- Four patio anchors included
- Assembly required; full-size instruction sheet included
- Great drop ship product!

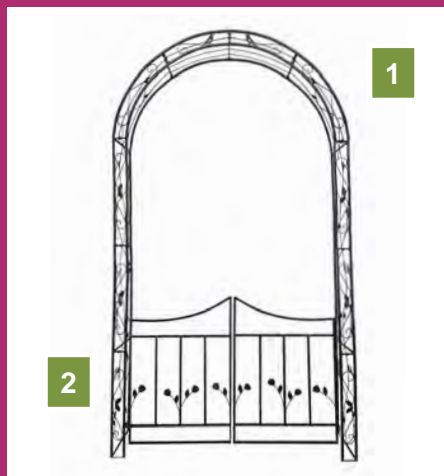

1

#39-1787 Garden Arch with Gate

Product: 15"D x 102"H x 56"W; 26lbs
Pack: 28"L x 8"H x 22"W; 28lbs



8 13269 01787 6

2

#39-1785 Garden Gate only

- Does not include anchors

Product: 1"D x 35.5"H x 49"W; 7.5lbs
Pack: 28"L x 8"H x 22"W; 9.1lbs



8 13269 01785 2

3

#39-1786 Garden Arch without Gate

Product: 15"D x 102"H x 56"W; 24lbs
Pack: 28"L x 8"H x 22"W; 26lbs



8 13269 01786 9

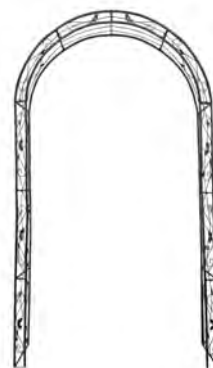
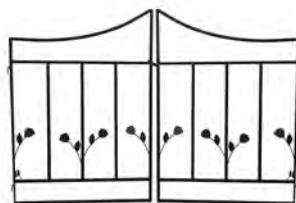



ALL OPTIONS
ARE GREAT FOR
DROPSHIP!

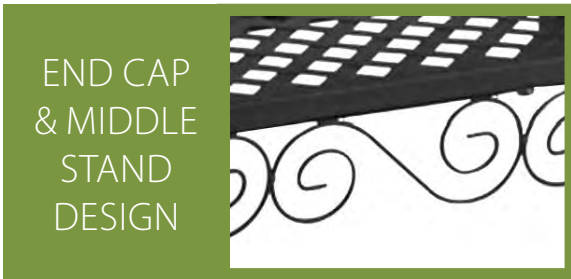

4 #39-100366N
Middle Plant Stand

- Easy to assemble

50lb weight limit per step
27.5"W x 23.5"D x 23.5"H; 19lbs



8 13269 01704 3

5 #39-110367N
End Cap Plant Stand

- Easy to assemble

50lb weight limit per step
23.5"W x 23.5"D x 23.5"H; 16lbs



8 13269 01705 0

CREATE YOUR OWN
GROUPING WITH
MULTIPLE STANDS!





SAVE YOUR KNEES!

Garden in comfort and make bleachers more bearable with our line of kneeling pads! Made from memory foam with a shock-absorbing foam core and waterproof neoprene cover in six bold colors. Machine washable and generously-sized with a convenient carrying handle. You'll want to take it with you everywhere - to the garden, to the game and more!



1

Memory Foam Kneeling Cushions

20"L x 12.25"W; 0.7lbs Pack Size: 12

#9-1902
Red



#9-1903
Orange



#9-1904
Yellow



#9-1905
Green



#9-1906
Blue



#9-1907
Violet



ORDER A MINIMUM OF 3 CASES OF KNEELING PADS AND RECEIVE THE DISPLAY STAND FOR HALF PRICE!

2

#33-1 Spinner Display Stand (stand only)

- Caster wheels included to allow for easy access to all colors or move around store

25"D x 81"H

3

#9-SIGN Kneeling Pad Display Sign

- Colorful and eye-catching

#9-1908MC Memory Foam Kneeling Cushion Mixed Case

- Total of 36 Kneeling Pads
- 6 of every color



KNEELING CUSHION DISPLAY

Made from memory foam with a shock-absorbing foam core and waterproof neoprene cover in six bold colors. Display comes complete with 72 cushions (12 of each color), stand, and header sign. Display stand has caster wheels.

NEW

#KC1000 Kneeling Cushion Display		
Part #	Description	QTY
9-1902	Red Memory Foam Kneeling Pad	12
9-1903	Orange Memory Foam Kneeling Pad	12
9-1904	Yellow Memory Foam Kneeling Pad	12
9-1905	Green Memory Foam Kneeling Pad	12
9-1906	Blue Memory Foam Kneeling Pad	12
9-1907	Violet Memory Foam Kneeling Pad	12
33-1	Spinner Display Stand	1
9-SIGN	Display Header	1
		72
#KC1000POG	Without display stand	

GREAT
STADIUM
SEAT



#KC1000
Kneeling Cushion Display
22"W x 22"D x 81"H



KNEE PADS

MAKE GARDENING MORE COMFORTABLE

The contoured shape, extra-durable padding and comfortable fasteners allow these kneeling pads to help lessen the stress from the toughest chores in the garden or the home. Protect your knees without the added bulk and just the right amount of cushion. The waterproof, neoprene outer cover is available in six bold colors.



- 1 Memory Foam Knee Pads**
- Made of extra-durable, shock-absorbing center with a waterproof, neoprene cover that is machine washable
 - Contoured shape and just the right amount of padding allows for comfortable wear without being too bulky
 - Easily fastened with 2 Velcro straps
 - Available in six bold colors
- 9"H x 7.25"W; 1lb Pack Size: 12

#9-1918
Red



#9-1919
Orange



#9-1920
Yellow



#9-1921
Green



#9-1922
Blue



#9-1923
Violet



#9-1924MC
Memory Foam
Knee Pad Mixed Case

- Total of 36 Knee Pads
- 6 of every color



A COMFORTABLE GARDENER IS A HAPPY GARDENER!

COLANDER TRUG

This colander trug is the perfect home companion! Collect all your vegetables from the garden in this generously sized trug, then simply rinse and drain whether outside or in. The colander holes along the edge of the trug make it easy to collect, rinse, and drain with no fuss, mess, or spillage.



2 #W7623 Green Kneeler Seat

- Use as a kneeler or as a seat
- Foam pad provides comfort
- The sturdy arms provide leverage to push yourself up
- Legs fold flat for easy storage
- Holds over 200lbs
- Best Seller!

23"W, 17"H Seat,
4.5"H Kneeler, 6lbs



3 #GP184 Colander Trug

- Made from heavy-duty plastic with added drainage holes on one end
 - Generously-sized trug allows you to harvest, wash and drain all without removing your product from the basket
 - No mess, no fuss, no spillage
- 22"L x 12"W x 5"H, 1.25lbs



SQUARE GARDEN TRAYS

- Available in 2 hard-to-find sizes
- Made of recycled polypropylene
- Features shallow horizontal ridges on the internal base of the tray to aid drainage from potted plants
- Besides gardening, these trays are equally useful as:
 - Commercial drip/spillage trays for oil and chemical storage
 - Sand pit for kids
 - Plant irrigation display tray
 - Mixing tray for cement
 - And much more!



DURABLE BOOT TRAYS

- Made of tough polypropylene
- Raised ridges allow for easy drainage & airing
- 3/8" high ridges help remove mud from shoes
- For garden, hiking, working or sports footwear
- Two-tiered model is easy to assemble



Black Boot Trays are made of 100% recycled plastic

1 #GP105B Two-Tier Black Boot Tray

31"L x 16"W x 20"H, 6.1lbs



5 031670 002495

3 #GP172B 32" Square Garden Tray

32"L x 32"W x 5"H; 5.5lbs



5 031670 003287

2 #GP83B Black Boot Tray

31"L x 16"W x 2"H, 2.5lbs



5 031670 002198

4 #GP112B 40" Square Garden Tray

40"L x 40"W x 5"H; 8.25lbs



5 031670 002570



MADE IN THE UK

PERFECT FOR PRIVATE & COMMERCIAL GARDENERS!

IDEAL FOR USE IN SEED STARTERS, IRRIGATION TABLES, HYDROPONICS, MIXING TRAYS AND MORE!

- Popular with private/commercial gardeners as large irrigation tables
- Ideal water reservoir tray for numerous pots
- Made from recycled polypropylene



**5 #GP45B
23" Square Garden Tray**

- Sized for standard greenhouse staging
- Over 6 gallon internal capacity

23"L x 23"W x 3"H; 3.5lbs



**6 #GP74B
Maxi Garden Tray**

- Comfortably holds 3 standard size seed trays
- Over 3 gallon internal capacity

31"L x 16"W x 1.5"H; 2.75lbs



**7 #GP81B
Giant Garden Tray**

- Giant internal capacity is over 6 gallons
- Shallow horizontal ridges on the base of the tray aid drainage

43"L x 21.5"W x 1.5"H; 5lbs





1



3



2



4

1 **#GP104**
2-in-1 Sieve

- Two interchangeable screens (0.24" & 0.47")
- Made from strong galvanized woven wire

13.8" Square x 5"D, 1.5lbs



5 031670 002471

2 **#GP55**
Fine Mesh Sieve

- A must-have around the potting table
- Galvanized mesh, 1/4" openings

14.25"L x 12.75"W x 5.5"H, 1.5lbs



5 031670 001597

3 **Tidy Tray**

- Bring garden work inside with no mess
- Use in the garage or as a play station for kids
- Tough one-piece potting tray
- Essential garden accessory

24.5"L x 22"W x 8"H, 3.25lbs

#GP48

- Green

#GP48B

- Black



5 031670 003171



5 031670 001009



4 **Tidy Tray Shelf**

- A perfect companion to the Tidy Tray
- Sits securely on top rim of the Tidy Tray and provides 3 recessed pockets to hold accessories and tools
- Made from recycled polypropylene

24.5"L x 8"W x 2.5"H, 1.5lbs

#GP72G

- Green

#GP72B

- Black



5 031670 002051



5 031670 003249

SELF-WATERING TRAYS

- Capillary watering trays ensure that plants are watered automatically for up to 14 days
- An inner support board (covered in capillary matting) is inside the outer reservoir tray
- The plants sit on the capillary matting and draw water as needed from the reservoir
- System doesn't over water and is perfect for use in the greenhouse or as a plant sitter
- Terra cotta pots work best with this system

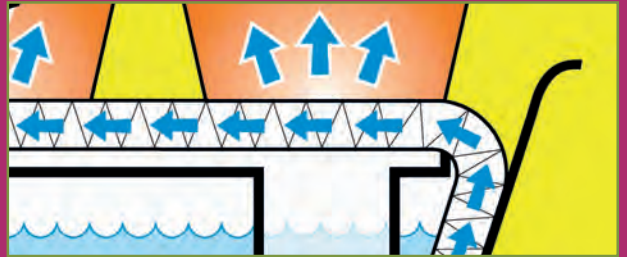

5 #GP70 Large Self-Watering Tray

23"L x 15.5"W x 2.25"H, 4.4lbs
(2.1 gallon reservoir)



6 #GP71 Windowsill Tray

30"L x 7"W x 1.5"H, 2.7lbs
(1 gallon reservoir)





THE ALL-IN-ONE WATERING AND CROP SUPPORT SOLUTION!

1 #GP167G Green Plant Halos (Set of 3)

- The 5.5" D central inner pot creates the planting area, while the outer 'moat' features 6 watering spikes which penetrate below the soil surface, delivering water directly to the plant's roots
- Ensures water and nutrients are delivered at a reduced rate so the plant is better able to absorb, preventing waste which is common with conventional watering
- Unique support system with 3 anchor slots that allows up to 4 canes to be joined at the peak (canes not included)
- Made from recycled, UV-stabilized plastic
- Guaranteed for 5 years

11"D x 6.5"H; 1.8lbs
5.5" inner pot opening



SELF-WATERING GROW POT TOWER

PERFECT FOR TOMATOES, PEPPERS, SWEET PEAS AND MORE!

- Kit includes grow pot, 5 ft aluminum 4 ring support frame and water float indicator
- Generous 3 gallon planting capacity for healthy plant development
- Easy fill self-watering system includes a 1 gallon reservoir
- Manufactured from 100% recycled plastic (BPA-free)
- Pot & frame feature "anchor" support for an optional central bamboo cane (cane not included)
- Unique float indicator shows reservoir water level
- Assembled tower is 5 ft high

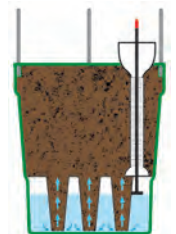

2 #GP195GR Self-Watering Grow Pot Tower

11"D x 6.5"H; 1.8lbs
5.5" inner pot opening



THREE SHELF GREENHOUSE

- Start plants outside before the planting season
- The heavy duty polyethylene walls create the perfect growing conditions for your plants
- Three shelves allow room to store more flats!
- Roll up zipper door with ties allows for easier access



3 #W4403
Three Shelf Greenhouse

27"W x 19"D x 49"H, 12lbs



6 928152 144035

TIERRA
Garden™

GREENHOUSE WAGON

PULL IN THE PROFITS WITH THIS VERSATILE WAGON...

This easy-to-handle, all-purpose wagon makes towing plants, mulch and other gardening items a breeze. The gridded bottom allows water and other liquids to easily drain. The heavy-duty frame and large all-terrain wheels let it go anywhere and it's also shipped flat packed!

1



ALL TERRAIN WHEELS ALLOW
WAGON TO GO ANYWHERE!

1

Greenhouse Wagon

- Load surface 9 sq. ft.
- Glides easily over the roughest of terrains
- Gridded bottom allows for drainage
- Ships flat-packed
- Load capacity: 660lb
- Overall Dimensions: 53"L x 30"W x 23"H
- Load Area: 45"L x 28"W x 8"H
- Wheel: 13"H x 5"W x 6"D (Rim)
- Handle equipped to attach to a lawn mower or UTV
- Heavy-duty frame and large all-terrain wheels
- UV protected, virgin plastic
- Assembly required

#45-1854F Wagon with No Maintenance Foam Wheels



8 13269 01855 2

#45-1854FWH Replacement Foam Wheel for Wagon 45-1854F



8 13269 01859 0



TIERRA
Garden™



WATERING CANS



1 **2.1 Gallon Traditional Metal Watering Cans**
 • Opening is 3.5" x 6"
 20"L x 9"W x 15.5"H; 2lbs

#36-5081MC
2.1 Gallon Traditional Metal Watering Cans Mixed Case
 • Total of 6 watering cans, one of every color

#36-5081R
Red 0 17783 05081 8

#36-5081O
Orange 0 17783 05082 5

#36-5081Y
Yellow 0 17783 05083 2

#36-5081G
Green 0 17783 05085 6

#36-5081B
Blue 0 17783 05084 9

#36-5081V
Purple 8 13269 01872 9

2 **Kids 1 Pt. Metal Watering Can**
 • Kids can water plants like grown ups with these brightly colored watering cans
 • Sold in 16 piece, assorted cases: pink, green, blue, and orange
 • Opening is 2.75" x 5"
 9"W x 3.5"D x 6"H, 0.3lb

#5070
Mixed Colors 0 17783 05070 2



TRADITIONAL METAL WATERING CANS

- Powder-coated, galvanized steel in a variety of colors
- Each can is QC tested and inspected before shipment
- Screw on, no leak roses
- Available in a mixed case pack that includes one of every color!



3



3 1.2 Gallon Traditional Metal Watering Cans
18"L x 7.5"W x 13"H; 1.5lbs

#36-3081MC
1.2 Gallon Traditional Metal Watering Cans Mixed Case
• Total of 6 watering cans, one of every color

#36-3081R
Red 8 13269 01925 2

#36-3081O
Orange 8 13269 01926 9

#36-3081Y
Yellow 8 13269 01927 6

#36-3081G
Green 8 13269 01928 3

#36-3081B
Blue 8 13269 01929 0

#36-3081V
Purple 8 13269 01930 6



AGED ZINC WATERING CANS

- Powder coated, galvanized steel
- Special finishing process gives this series the look of aged zinc
- Screw on, no leak rose



1 #36-5041L
2.1 Gal. Aged Zinc Watering Can
 Oval shape: 23"W x 7"D x 14"H; 2.5lbs



2 #36-5041M
1.3 Gal. Aged Zinc Watering Can
 Oval shape: 22"W x 6"D x 11"H; 1.75lbs



3 #36-5041S
0.7 Gal. Aged Zinc Watering Can
 Oval shape: 17"W x 5"D x 10"H; 1.25lbs



SPECIAL FINISHING PROCESS
 AND SCREW ON, NO LEAK ROSES

NO ORDINARY PVC WATERING CAN!

- Most of us typically think of plastic as inferior, but nothing about this line is cheap: timeless design, the best materials, and superior manufacturing
- Made in Germany from the finest, environmentally friendly cadmium-free polypropylene, polystyrene, and polyethylene materials...no ordinary PVC!
- Stated simply - these cans are a great value!



**STRONG.
IMPACT
RESISTANT.**

1 1 Pt. Mini Plastic Watering Can

- Like a smaller version of our standard PVC watering cans
 - Kids can easily water plants
 - Great for indoor plants
 - Cases sold by individual color
- 10"W x 2.75"D x 5.5"H; 0.15lb

#5001B
Blue



#5001G
Green



#5001P
Pink



#5001MC 15 Can Mixed Case
5 of each color



2 #5013 3.5 Gallon Green PVC Watering Can

24"W x 8"D x 15"H; 1.25lbs



3 2.7 Gallon PVC Watering Cans

21"W x 7"D x 13"H; 1lb

#5010B
Blue



#5010G
Green



#5010GRY
Gray



#5010MC 15 Can Mixed Case
5 of each color



4 1.3 Gallon PVC Watering Cans

17"W x 6"D x 11"H; 0.5lb

#5005B
Blue



#5005G
Green



#5005GRY
Gray



#5005MC 15 Can Mixed Case
5 of each color





ORGANIC & HYDROPONIC GARDENING



COMPOSTING

TURN FOOD SCRAPS AND YARD WASTE INTO THE BEST ORGANIC SOIL

1

#9487 45-Gallon Compost Tumbler

- Heavy-duty steel tube frame construction
- Drum is constructed from 90% recycled plastic material
- Cuts down on your household garbage by recycling organic materials
- Features two wheels on the frame for easy mobility
- Enables air circulation to speed composting
- Built-in mixing fins help break up clumps

39.2"L x 31.1"W x 35.43"H, 7 Cu. Ft.



6 936863 094877

2

#625001 Eco Composter

- Turns kitchen waste into rich compost
- Rotate lid to fill compost
- Lateral ventilation slots for fast composting
- 100% recycled UV-resistant polypropylene
- Sliding bottom exit door
- Composter sits directly on the ground
- Smooth interior and exterior for easy cleaning
- Stackable for lower shipping cost and space savings!
- Made in Germany

31"D x 33"H, 16.4lbs, 74 Gal.



4 023122 110125



**GREAT FOR
DROPSHIP!**



**DON'T
FORGET THE
ACCESSORIES!
PAGE 130-131**



3

**#627004 & #627001
Eco King Composters**

- Turns kitchen waste into rich compost
- Two large top flaps for easy filling
- Secure wind-proof latches keep top closed
- No tools required for assembly - panels snap together
- Constructed from 100% recycled UV-resistant polypropylene
- Composter sits directly on the ground
- Folding bottom exit door
- Folds flat for storage or shipping
- Made in Germany

**#627004
Small Black Eco King Composter**
27.5"L x 27.5"W x 32.5"H, 17.6lbs, 105 Gal.



4 023122 147275

**#627001
Large Green Eco King Composter**
31.5"L x 31.5"W x 37.5"H, 27lbs, 158 Gal.



4 023122 147244



4

**#628000
79 Gal. Eco Master Composter**

- Great one-piece feed opening
- Lid with wind protection
- Easy and convenient assembly without tools
- Convenient withdrawal of compost thanks to a big flap with handle
- Ideal ventilation
- Requires little space
- Constructed from 100% recycled UV-resistant polypropylene
- Made in Germany

25.6"L x 23.6"W x 35.5"H, 79 Gal.



4 023122 154525



**GREAT FOR
DROPSHIP!**



**1 #626050 and #626051
158-Gallon Thermo Wood Composters**

- Thermal composter with wood-look finish
- Made from Thermolen® - UV & weatherproof material
- Thermolen® keeps heat inside composter to accelerate the composting process
- Easy to fill with two large filler flaps
- Convenient compost removal with openings in front and back
- No tools required for assembly - panels snap together
- Ingenious aeration system includes ventilation on all four sides concealed under panels to maintain decorative style
- Soil Fence included in #626051
- Folds flat for storage or shipping
- Made in Germany

#626050 Thermo Wood Composter
31.5"L x 31.5"W x 39.4"H, 40lbs, 158 Gal



#626051 Thermo Wood Composter with Soil Fence
31.5"L x 31.5"W x 39.4"H, 43lbs, 158 Gal



**2 #9491
115-Gallon Composter**

- Single lid that stays open and makes the loading and stirring of compost easier
 - 4 panels, no tools required for easy assembly
 - Economical shipping size— flat packed
 - Constructed from 90% recycled materials
 - Unique construction enables air circulation to speed up composting
 - Easy access from all four sides
 - Wind-Safe snap lock cover
- 33.5"L x 33.5"W x 31.5"H, 30lbs, 17 Cu. Ft.



GREAT FOR DROPSHIP!



3



**SOIL FENCES
AVAILABLE FOR
THERMO KING
COMPOSTERS**



4



5

**HAXNICKS
ROLLMIX
COMPOSTER
QUICK TIPS!**



**3 #626002 and #626003
Thermo King Composters**

- Turns kitchen waste into rich compost
- Thermolen®- UV & weatherproof material, keeps heat inside composter to accelerate the composting process
- Secure, wind-proof latches keep top closed
- No tools required for assembly - panels snap together
- Folding bottom exit door
- Optional Soil Fence
- Folds flat for storage or shipping
- Made in Germany

**#626002 Small
Thermo King Composter**

31.5"L x 31.5"W x 50"H, 37lbs, 160 Gal.



4 023122 143215

**#626003 Large
Thermo King Composter**

39.3"L x 39.3"W x 39.3"H, 46.2lbs, 240 Gal.



4 023122 143222

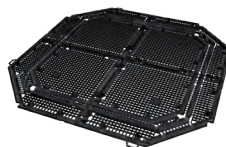

**4 #626102 and #626100
Thermo King Soil Fences**

- Enables microorganisms to gain access to the Thermo King, while protecting against rodents
- Optional accessory for the Thermo King Composters

**#626102
Soil Fence for #626002**

2.2lbs



4 023122 144533

**#626100
Soil Fence for #626003**

5lbs



4 023122 143239

**5 #50-1500
Rollmix Composter**

- Home composting has never been easier, quicker or more fun!
- The polyethylene fabric traps heat, and by adding water and rolling, it is possible to make your own compost in 6 weeks
- Perfect if you are living in a rental property or have limited space
- Folds flat for easy storage

Product: 26"L x 22"D, 2.6lbs
Pack: 22.5"W x 1.5"D x 22.5"H
Pack Size: 1



6 51609 21304 1





1



2



3



Caddies help separate food waste, and are a great tool to have around the organic garden. Store food waste in the kitchen without odor between trips to the composter.



Use Caddies to remove fresh compost from the composter



Save trips to the composter! Only add waste to composter when the caddy is full!

ODOR-FREE COMPOST CADDIES

- Tight-fitting lids
- Sturdy, yet lightweight
- Activated charcoal filter in the lid to neutralize odors
- Filters last up to 4 months
- Replacement filters & bags available
- Made in England

1 #GP118 Mini Compost Caddy

- 1.3 gallon capacity
- 1 filter included (#GP99)
- Uses #GP122 bio bags

6.5"W x 8.5"D x 8"H



5 031670 002648

2 #GP98 Midi Compost Caddy

- 2.5 gallon capacity
- 1 filter included (#GP99)
- Uses #GP115 bio bags

8.5"W x 6.5"D x 14"H, 1.5lbs



5 031670 002396

3 #GP113 Jumbo Compost Caddy

- 8 gallon capacity
- 1 filter included (#GP99)
- Uses #GP116 bio bags

14.5"W x 11"D x 14"H, 3lbs



5 031670 002587



Caddies are made of 100% recycled plastic

COMPOSTING IS GREAT FOR THE GARDEN AND THE ENVIRONMENT

COMPOST IMPROVES SOIL, ADDS NUTRIENTS FOR PLANTS, HELPS SOIL RETAIN WATER & REDUCES THE NEED FOR EXPENSIVE FERTILIZERS



- 4** **#GP99 Replacement Odor Filters**
- Absorbs odor for up to 4 months
 - Comes in packs of 6
 - Fits #GP98, #GP113, and #GP118 Caddies



5 031670 002402

- 5** **#GP122, #GP115, & #GP116 Biodegradable Caddy Bags**
- Just toss in composter!

#GP122
(20 bags for Mini #GP118)



5 031670 002686

#GP115
(20) bags for Midi #GP98)



5 031670 002600

#GP116
(10 bags for Jumbo #GP113)



5 031670 002617

- 6** **#31-2942 DeWit Compost Digging Scoop**

- Thick blade has sharp front edge, great for scooping
- Easy turn T-handle

Total Length: 25"L x 4.5"W, 1.5lbs



8 714936 029425

- 7** **#31-0806 DeWit Cork Screw Aerator**

- Use to turn compost and create channels for air and moisture
- Easy turn T-handle

Total Length: 40"L x 1.5"W, 2.5lbs



8 714936 086664





ERGO RAISED BED

- Made from recycled polypropylene with a decorative wood texture
- Stackable design and extender panels allow for a variety of heights and lengths
- Can also be used as a composter
- 5 year warranty
- Ships flat-packed
- No tools required for assembly
- Made in Europe
- UV-protected
- Can be left outdoors in every season

1 #645100 Ergo Raised Bed

- Sets are stackable to make gardening more easily accessible
- One set holds 52 gallons of soil
- Garden at a comfortable height and decrease strain on your back
- Add the optional Ergo Extender Panels (#645101) to increase length of raised bed by nearly 2 feet

37.5"W x 9.8"H, 9lbs, 52 Gal



4 023122 214106



1 SET

2 #645101 Ergo Raised Bed Extension Set

- Ergo Extender Panels increase length of raised bed by nearly 2 feet
- Set includes two 22" panels, two adapters and a support wire
- Increases raised bed capacity to 84 gallon per set
- Simply clicks in to Ergo Raised Bed allowing for a variety of configurations

22"L x 9.8"H, 3lbs



4 023122 213451



1 SET WITH EXTENSION



SEE THE ERGO RAISED BED IN ACTION!
WWW.GARANTIA.EU

ELEVATE YOUR GARDEN TO THE NEXT LEVEL



MODERN GARDENING SOLUTION FOR BALCONIES AND PATIOS

#645115, #645116, #645117 Ergo Raised Bed

- Made from recycled polypropylene
- 5 Year warranty
- No tools required for assembly - panels snap together
- Sets are stackable to make gardening more easily accessible
- Garden at a comfortable height and decrease strain on your back
- Colorful, easy to follow instructions included

3 #645115 Ergo Quadro Small Raised Bed - 23.7 Gal

23.6"L x 23.6"W x 9.8"H, 6.6lbs



4 #645116 Ergo Quadro Medium Raised Bed - 29 Gal

23.6"L x 31.5"W x 9.8"H, 7.7lbs



5 #645117 Ergo Quadro Large Raised Bed - 40 Gal

31.5"L x 31.5"W x 9.8"H, 8.4lbs



URBAN BALCONY RAISED BED

- Made from recycled polypropylene
- Decorative surface with wood texture
- Ideal for herbs, veggies and other plants
- Versatile - can be used with or without legs
- 5 year warranty
- Easily assembled with no tools required
- Made in Europe
- UV-protected
- Can be left outdoors in every season

6 #645140 Urban Balcony Raised Bed

- Drainage hose can be attached to adapter on bottom of planter
 - Can be used w/ or w/out included legs
- 23.6"L x 23.6"W x 9.8"H, 12.6 Gal



7 #645141 Urban Cloche Cover

- Made from UV-protected polypropylene
 - Promotes accelerated growth for an early harvest
 - The safe way to protect from cold, birds and other pests
 - Gently water plants through water recesses and drip holes in cover
- 23.6"L x 31.5"W x 9.8"H



8 #645000 Urban Raised Bed Combo



PINE & SPRUCE RAISED BED

ASSEMBLY REQUIRED

- Tanalith water based treatment—extends the life of wood and maintains natural appearance
- Hardware and predrilled holes included



1 #4435 Rectangular On-Ground Raised Bed

- 6 sections
- 119 gallon capacity
- Geotextile fabric included

78.75"W x 39.25"L x 11" Deep, 34lbs
Pack Size: 81"W x 8.5"D x 5"H



3 #4437 Square Raised Bed with Shelf

- 4 sections
- Geotextile fabric included
- 42 gallon capacity

31.5"W x 31.5"L x 9.5" Deep, Overall height 34.5", 44 lbs
Pack size 37"L x 32"W x 7"H



2 #4436 Square On-Ground Raised Bed

- 9 sections
- 42 gallon capacity

39.4"W x 39.4"L x 7" Deep, 25 lbs
Pack size: 41"L x 9"W x 4"H



4 #4438 Rectangular Raised Bed with Shelf

- 6 sections
- Geotextile fabric included
- 66 gallon capacity

47.2"W x 31.5"L x 9.5" Deep, Overall height 34.5", 75 lbs
Pack size 49"L x 36"W x 6"H





5 **#5051**
Tiered Hanging Garden Shelf Station

- Treated for protection against wood rot and decay
- Made from FSC timber from well managed forests
- Ships flat packed with clear assembly instructions
- 7 shelves, ideal for sitting pots of herbs, vegetables or plants
- Can be hung on a wall or stood up on a balcony, includes hangers
- Stained gray with linseed oil
- Treat annually to prolong appearance and strength

32.7"W x 5.9"D x 29.5" H, 25 lbs. 90lb capacity
 Shelf width: 5.5" – Shelf depth – 3.9"



6 **#5052**
Hexagonal Raised Bed

- Treated for protection against wood rot and decay
- Made from FSC timber from well managed forests
- No need to bend down to tend to flowers and plants
- Shipped with textile liners
- Ships flat packed with clear assembly instructions
- Treat annually to prolong appearance and strength

22.8"L x 26.4"W x 37.8"H, 37 lbs. 90lb capacity
 Flower Box size: 22.8"L x 26.4"W x 11"H
 Flower Box Inside Dimensions: 20.5"L x 24"W x 9.1"Deep



6



1

#5055

Gardener's table with tin surface

- Treated for protection against wood rot and decay
- Made from FSC timber from well managed forests
- Tin work surface for added protection
- Bottom shelf for storing tools and planting accessories
- Ideal for potting plants and transplanting seedlings
- Ships flat packed with clear assembly instructions
- Treat annually to prolong appearance and strength

42.5"L x 20.5"W x 36.2"H, 38lbs, 110lb capacity
Pack: 44" x 21" x 6"



4 752072 535398

2

#5056

Gardener's table with wheels, cabinet and drawer

- Treated for protection against wood rot and decay
- Made from FSC timber from well managed forests
- Tin work surface for added protection
- Bottom shelf, cupboard and drawer for storing away accessories and tools
- Ships flat packed with clear assembly instructions
- Useful wheels for moving around and storing away when not in use
- Ideal for potting plants and transplanting seedlings
- Treat annually to prolong appearance and strength

42.5"L x 20.5"W x 35.4"H, 73lbs, 176lb capacity
Pack: 48" x 22" x 8"



4 752072 700826

TIERRA
Garden™





WAGNER[®]
design yourself

PLANT CADDIES

WPC PLANT CADDIES



INDOOR & OUTDOOR

- Made from highly durable Wood Plastic Composite, making them virtually indestructible
- 25 Year Guarantee!
- Perfect for indoor or outdoor use
- Water and UV-Resistant
- Non-slip surface keeps planters safely in place
- Load capacity 176-330 lbs



1 11"



2 11"



3 15"



4 15"



5 20"



6 20"

1 #64-0535 WPC Round Terra Cotta Plant Caddy

- With Brakes
- 220lbs. capacity
11.4"D x 2.75"H, 2.7lbs



4 001073 257007

3 #64-0555 WPC Large Round Terra Cotta Plant Caddy

- With Brakes
- 330 lbs. capacity
15.1"D x 4.5"H, 4.85 lbs.



4 001073 058505

5 #64-0575 WPC Extra Large Round Terra Cotta Plant Caddy

- With Brakes
- 265 lbs. capacity
20"D x 4.4"H, 6.5 lbs.



4 001073 027082

7 #64-0520 WPC Square Gray Plant Caddy

- With Brakes
- 176lbs. capacity
11.4"D x 2.75"H, 3.2lbs



4 001073 452211

2 #64-0525 WPC Round Gray Plant Caddy

- With Brakes
- 220lbs. capacity
11.4"D x 2.75"H, 2.7lbs



4 001073 451351

4 #64-0545 WPC Large Round Gray Plant Caddy

- With Brakes
- 330 lbs. capacity
15.1"D x 4.5"H, 4.85 lbs.



4 001073 256406

6 #64-0565 WPC Extra Large Round Gray Plant Caddy

- With Brakes
- 265 lbs. capacity
20"D x 4.4"H, 6.5 lbs.



4 001073 214406

8 #64-0530 WPC Square Terra Cotta Plant Caddy

- With Brakes
- 176lbs. capacity
11.4"D x 2.75"H, 3.2lbs

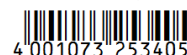

4 001073 253405



7 11"



8 11"



9 15"



10 15"



11 11"



12 11"



13 15"



14 20"

9 #64-0540 WPC Large Square Gray Plant Caddy
 265lbs. capacity
 15.4"D x 4.5"H, 6lbs



4 001073 413557

11 #64-0531 WPC Square Taupe Plant Caddy
 • With Brakes
 176lbs. capacity
 11.4"D x 2.75"H, 3.2lbs



4 001073 338515

13 #64-0556 WPC Large Round Taupe Plant Caddy
 330lbs. capacity
 15.1"D x 4.5"H, 4.85lbs



4 001073 212884

10 #64-0550 WPC Large Square Terra Cotta Plant Caddy
 265lbs. capacity
 15.4"D x 4.5"H, 6lbs



4 001073 029178

12 #64-0536 WPC Round Taupe Plant Caddy
 • With Brakes
 220lbs. capacity
 11.4"D x 2.75"H, 2.7lbs



4 001073 212792

14 #64-0576 WPC Extra Large Round Taupe Plant Caddy
 265lbs. capacity
 20"D x 4.4"H, 6.5lbs



4 001073 337631



1



2



3

INDOOR/OUTDOOR PLANT CADDIES

1

#64-0871 Round Beech Gigant

- With Brakes
- 551 lbs. capacity,
17.7"D x 5"H, 5.4 lbs.



4 001073 026573

2

#64-0870 Square Beech Gigant

- With Brakes
- 551 lbs. capacity,
17.7"D x 5.25"H, 6 lbs.



4 001073 412055

3

#64-0879 Vintage Rectangular Wooden Plant Caddy

- Water resistant with a color
protection coating

330 lbs. capacity
31"L x 11.5"W x 3.4"H, 3.6 lbs.



4 001073 485622



4



6



5

WAGNER[®]
design yourself

SEE PLANT CADDIES
IN ACTION FEATURING
WOODY FROM WAGNER



INDOOR/OUTDOOR PLANT CADDIES

4 #64-0421
Square Chestnut Pine
265 lb. capacity
15"D x 3.75"H, 3.1 lbs.



4'001073'140736

5 #64-0422
Square Gray Pine
265 lb. capacity
15"D x 3.75"H, 3.1 lbs.



4'001073'338317

6 #64-7090
Square Dark Pine
• With Brakes
441 lb. capacity, 15.7"D x 4.5"H, 4.3 lbs.



4'001073'092646

BAMBOO PLANT CADDIES

INDOOR ONLY

- Made from environmentally-friendly bamboo
- Swivel casters easily glide across varying surfaces



WOOD PLANT CADDIES

INDOOR ONLY



- FSC® Certified
- Smooth-rolling casters won't mark floors



1 #64-0265
Square Bamboo Plant Caddy
220 lbs. capacity
11.4"D x 2.75"H, 1.65 lbs.



3 #64-0319
Round Beech Wooden Pallet Plant Caddy
220 lbs. capacity
13.75"D x 3"H, 2 lbs.



5 #64-0205 **Square Pine Dark Wash Ribbed Plant Caddy**
• Non-slip surface
220 lbs. capacity, 11"D x 3.3"H, 2 lbs.



2 #64-0267
Round Bamboo Plant Caddy
220 lbs. capacity
11.4"D x 2.75"H, 1.4 lbs.

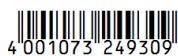

4 #64-0097
Small Square Beech Wooden Pallet Plant Caddy
220 lbs. capacity
9.8"D x 3.2"H, 1.65 lbs.



6 #64-0852 **Square Pine Dark Wash Wooden Pallet Plant Caddy**
220 lbs. capacity, 11.4"D x 3.3"H, 2 lbs.



7 #64-0268 **Round Birch Medium Wood Plant Caddy**
110 lbs. capacity, 9.8-11.8" D x 3.25" H, 2.5 lbs



INDOOR PLANT CADDIES



8



10



9



11

8 #64-0272 Chestnut Round Plant Caddy with No Show Casters

- Made from sustainably harvested beech

220 lbs. capacity
9.6"D x 1.8"H, 2.3 lbs.



4 001073 484755

9 #64-0271 Natural Round Plant Caddy with No Show Casters

- Made from sustainably harvested beech

220 lbs. capacity
9.6"D x 1.8"H, 2.3 lbs.



4 001073 088939



MADE FROM
SUSTAINABLY
HARVESTED
RESOURCES

10 #64-0864 Small Round Ribbed Gray Plant Caddy

- Non-slip surface
- Color protection coating

220 lbs. capacity
11.4"D x 3.5"H, 2.3 lbs.



4 001073 214833

11 #64-0863 Large Round Ribbed Gray Plant Caddy

- Non-slip surface
- Color protection coating
- Rubber wheels with brakes

441 lbs. capacity
15"D x 4"H, 4.2 lbs.



4 001073 027761

INDOOR/OUTDOOR PLANT CADDIES

DIAMOND PLATED ALUMINUM

ALUMINUM



1



3



5



2



4



6



7

1 #64-7005 Diamond Plated, Round Aluminum
 • Rubber Wheels with Brakes
 220 lbs. capacity
 11.8"D x 2.75"H, 2.2 lbs.



4 001073 025170

3 #64-1390 Diamond Plated, Large Square Aluminum
 331 lbs. capacity
 17.7" Load Surface
 18.5"W x 18.5"D x 4"H, 5.8 lbs.



4 001073 338423

5 #64-7006 Black Aluminum, Large Round
 • Rubber Wheels with Brakes
 331 lbs. capacity
 15"D x 2.75"H, 2.6 lbs.



4 001073 727890

2 #64-7002 Diamond Plated, Large Round Aluminum
 • Rubber Wheels with Brakes
 220 lbs. capacity,
 15"D x 2.75"H, 2.7 lbs.



4 001073 025378

4 #64-7003 Diamond Plated, Square Aluminum
 • Rubber Wheels with Brakes
 330 lbs. capacity
 11.4"W x 11.4"D x 2.75"H, 2.3 lbs.



4 001073 411225

6 #64-7007 Black Aluminum, Medium Round
 • Rubber Wheels with Brakes
 331 lbs. capacity
 11.8"D x 2.75"H, 2.2 lbs.



4 001073 727784

7 #64-7008 Black Aluminum, Medium Square
 • Rubber Wheels with Brakes
 331 lbs. capacity
 11.4"W x 11.4"D x 2.75"H, 2.3 lbs.



4 001073 727678

INDOOR/OUTDOOR PLANT CADDIES

CAST IRON



8



10



9



11

8 #64-0919
Smoke Gray Cast Iron, Round

- With Brakes
- 110 lbs. capacity
11.4"D x 2.6"H, 3.9 lbs.



4 001073 212983

10 #64-0923
White Cast Iron, Round

- With Brakes
- 110 lbs. capacity
11.4"D x 2.75"H, 3.25 lbs.

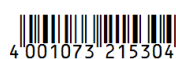

4 001073 215304

9 #64-0920
Pewter Cast Iron, Round

- With Brakes
- 165 lbs. capacity
15"D x 2.5"H, 7.3 lbs.



4 001073 213096

11 #64-0918
Slate Gray Cast Iron, Round

- With Brakes
- 110 lbs. capacity
11.4"D x 2.25"H, 3.8 lbs.



4 001073 431087

WAGNER[®]
design yourself

INDOOR/OUTDOOR PLANT CADDIES

STEEL

STONE



1



3



2



4

1 #64-0936
Flower Steel, Round
 • With Brakes
 220 lbs. capacity
 11.8"D x 2.25"H, 1.8 lbs.



4 001073 430677

3 #64-0902
Concrete, Round
 • With Brakes
 220 lbs. capacity
 13.4"D x 3"H, 7.8 lbs.



4 001073 483840

2 #64-0937
Flower Steel, Square
 • With Brakes
 176 lbs. capacity
 11.8"W x 11.8"D x 2.25"H, 2.1 lbs.



4 001073 430783

4 #64-0903
Concrete, Swirl
 • With Brakes
 176 lbs. capacity
 11"D x 3"H, 5.2 lbs.



4 001073 727562

WAGNER[®]

design yourself



INDOOR PLANT CADDIES



5



7



6



8

5 #64-0275
Round Rollo Décor
• No Show Casters
220 lbs. capacity,
11.4"D x 1.1"H, 2.4 lbs.



4'001073'509472'

7 #64-0430
Square Silver Poplar
220 lbs. capacity
9.8"D x 3.25"H, 1.6 lbs.



4'001073'212761'

6 #64-0276
Clover Décor
• No Show Casters
220 lbs. capacity
13"D x 1.625"H, 2.8 lbs.



4'001073'509793'

8 #64-0431
Square Gold Poplar
220 lbs. capacity
9.8"D x 3.25"H, 1.6 lbs.



4'001073'338447'



SEE PLANT CADDIES IN ACTION AND MAKE MOVING PLANTS A BREEZE WITH WOODY FROM WAGNER!

MAXIGRIP PLANT CADDIES

INDOOR & OUTDOOR

- The sturdiest plant caddy around!
- 50% birch and 50% poplar
- Easily move oversize indoor containers outdoors
- Made from sustainably harvested poplar with a sure-grip surface to keep planters securely in place
- Smooth polypropylene casters plus a water-repellent finish make it ideal for indoor and outdoor use
- Load capacities between 441-661 lbs!



4



3



1

1 #64-1351 Small Round MaxiGrip Plant Caddy

441lbs. capacity
11.4"D x 3.5"H, 2.7lbs



4 001073 411348

2 #64-1306 Round MaxiGrip Plant Caddy

441lbs. capacity
15"D x 3.875"H, 3.7lbs

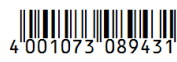

4 001073 089431

4 #64-1308 Square MaxiGrip Plant Caddy

441lbs. capacity
15"D x 4"H, 4.1lbs



4 001073 136067

3 #64-1168 Large Round MaxiGrip Plant Caddy

- With Brakes
- 661lbs. capacity
22.8"D x 5.7"H, 10.65lbs



4 001073 135572



SUN CITY ADJUSTABLE PLANT CADDIES

INDOOR & OUTDOOR

- Easily adjusts to fit different-sized containers
- Rust-proof metal
- Water resistant

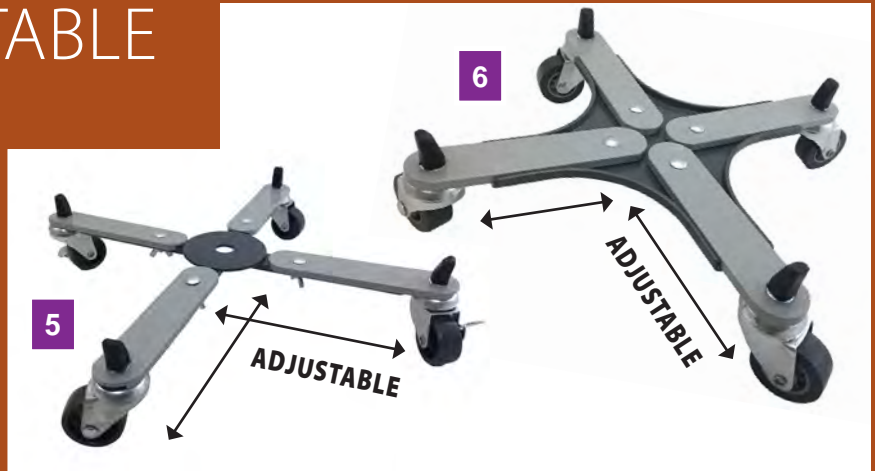

WIRE PLANT CADDIES

INDOOR



5 #64-0827
Sun City Basic Adjustable Plant Caddy
 • Extends from 12.2"D up to 16.5"D
 • Swivel caster wheels with brakes
 220 lbs. capacity
 Expands from 12.2 to 16.5"D x 2.25"H, 2.7 lbs.



4 001073 082678

6 #64-0818
Sun City Medium Adjustable Plant Caddy
 • Extends from 11"D up to 16.1"D
 • Soft rubber wheels protect floors
 • Reinforced frame for stability
 220 lbs. capacity
 Expands from 11 to 16.1"D x 2.75"H, 3.3 lbs.



4 001073 081275

7 #64-0933
Round Black Wire Plant Caddy
 132 lbs. capacity
 11.8"D x 2.5"H, 1.1 lbs.

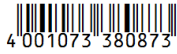

4 001073 380873

8 #64-0934
Round Black Steel Plant Caddy
 220 lbs. capacity
 15"D x 3.75"H, 2.2 lbs.



4 001073 212662

9 #64-0800
Pot Feet
 110 lbs. capacity
 Expands from 4.7 to 7.8"D, 0.5 lbs.



4 001073 095265

10 #64-0929
Round Chrome Wire Plant Caddy
 • 30 caddies on wire stand
 132 lbs. capacity
 11.8"D x 2.5"H, 1.4 lbs.



4 001073 256437



PLANT CADDY WIRE DISPLAY STANDS

INDOOR & OUTDOOR



THE PORTABLE WIRE DISPLAYS ARE EASILY MOVED AROUND THE STORE AND INEXPENSIVE SO YOU CAN SHOWCASE A VARIETY OF CADDIES NEAR YOUR PLANTERS.

1 #64-2810
Small Round Wire Display
(caddies not included)

Holds 20-24 Caddies with 11"D
13"D x 39.5"H, 1lb.



2 #64-2820
Large Round Wire Display
(caddies not included)

Holds up to 16 Caddies with 15"D
15"D x 39.5"H, 1lb.



#64-2811
11.4" WPC Round Caddy Display

Includes

- (1) 64-2810 Display
- (8) 64-0535 Terra Cotta
- (8) 64-0525 Gray
- (8) 64-0536 Taupe



#64-2821
15" Aluminum Round Caddy Display

Includes

- (1) 64-2820 Display
- (16) 64-7006 Black
- (16) 64-7002 Silver



**BUY \$350
OF PLANT
CADDIES &
RECEIVE A
FREE
WIRE
DISPLAY
STAND**



INCREASE IMPLUSE BUYS WITH PLANT CADDY WIRE DISPLAY STAND

Keep plant caddies top of mind for your customers by showcasing them near your container displays.



3

STRATEGICALLY PLACE CADDIES NEXT TO COORDINATING COLORED CONTAINERS TO MAKE THE BIGGEST IMPACT.

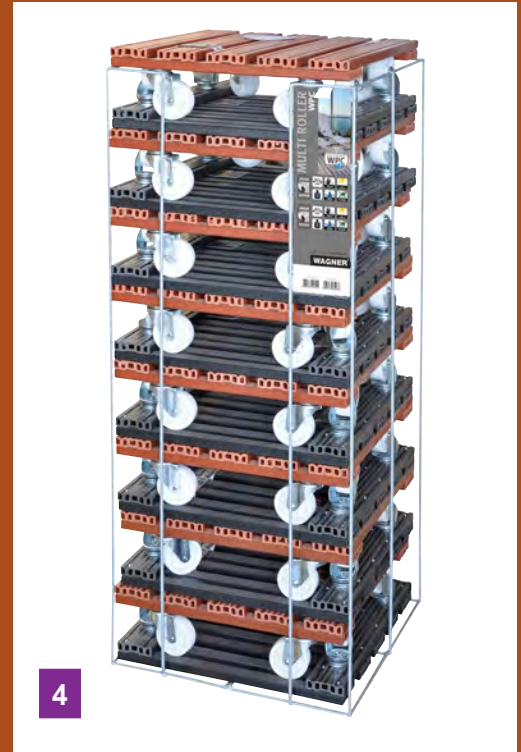

4

3 #64-2830 Small Square Wire Display (caddies not included)

Holds 20-24 Caddies with 11"D
12.25"L x 12.25"W x 39.5"H, 11lb.



4 001073 415759

#64-2831 11.4" Metal Caddy Display

Includes

- (1) 64-2830 Display
- (16) 64-0937 Square Flower
- (16) 64-0936 Round Flower
- (16) 64-7008 Square Aluminum



8 13269 01486 8

4 #64-2840 Large Square Wire Display (caddies not included)

Holds up to 16 Caddies with 15"D
15.25"L x 16"W x 39.5"H, 11lb.

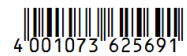

4 001073 625691

#64-2841 15.4" WPC Square Caddy Display

Includes

- (1) 64-2840 Display
- (12) 64-0540 Gray
- (12) 64-0550 Terra Cotta



8 13269 01700 5

INCREASE CADDY SALES UP TO 30%



WPC PLANT CADDY DISPLAY



- 64 caddies total
- Showcase a wide selection of plant caddies all in one convenient display
- Indoor / Outdoor

#PC1000 WPC Plant Caddy Display		
Part #	Description	QTY
Row 1		
#64-0530	WPC Square Terra Cotta 11.4"D	4
#64-0531	WPC Square Taupe 11.4"D	4
#64-0520	WPC Square Gray 11.4"D	4
#64-0520	WPC Square Gray 11.4"D	4
Row 2		
#64-0535	WPC Round Terra Cotta 11.4"D	4
#64-0536	WPC Round Taupe 11.4"D	4
#64-0525	WPC Round Gray 11.4"D	4
#64-0525	WPC Round Gray 11.4"D	4
Row 3		
#64-0555	WPC Round Terra Cotta 15.1"D	4
#64-0556	WPC Round Taupe 15.1"D	4
#64-0545	WPC Round Gray 15.1"D	4
Row 4		
#64-0550	WPC Square Terra Cotta 15.4"D	4
#64-0540	WPC Square Gray 15.4"D	4
#64-0545	WPC Round Gray 15.1"D	4
Bottom		
#64-0575	WPC Round Terra Cotta 20"D	4
#64-0565	WPC Round Gray 20"D	4
	Caddy Display Pallet & Accessories	1
		64
#PC1000POG	Without display stand	



#PC1000
WPC Plant Caddy Outdoor Display
 46.5"W x 31"D x 77"H, 445 lbs

SMALL WPC PLANT CADDY DISPLAY



- 60 caddies total
- Feature a selection of caddies
- Indoor / Outdoor

NEW

#PC2000 Small WPC Plant Caddy Display		
Part #	Description	QTY
#64-0530	WPC Square Terra Cotta 11.4"D	8
#64-0531	WPC Square Taupe 11.4"D	8
#64-0520	WPC Square Gray 11.4"D	12
#64-0535	WPC Round Terra Cotta 11.4"D	12
#64-0536	WPC Round Taupe 11.4"D	8
#64-0525	WPC Round Gray 11.4"D	12
1500B	Black Metal Display	1
		60
#PC2000POG	Without display stand	



#PC2000
Small WPC Plant Caddy Display
 18.5"W x 22"D x 87"H

ASSORTED PLANT CADDY DISPLAY



- 136 caddies total
- Show a mix of indoor and outdoor caddies to meet the needs of your customers
- Indoor / Outdoor

#PC5000 Assorted Plant Caddy Display		
Part #	Description	QTY
Row 1		
#64-0556	WPC Round Taupe Large	4
#64-0545	WPC 15" D Round	4
#64-1306	Round Maxigrip	6
Row 2		
#64-0097	Small Square Wooden Pallet	8
#64-0531	WPC Square Taupe	8
#64-0205	Square Dark Wash Ribbed	8
#64-0933	11.8" D Round Black Wire	12
Row 3		
#64-0267	Bamboo Round 11.4" D	4
#64-0536	WPC Round Taupe	4
#64-0903	Swirl Stone Round	4
#64-0923	White Cast Iron	8
Row 4		
#64-0319	Round Wooden Pallet	10
#64-0525	WPC 11.4" D Round	4
#64-0520	WPC Square 11.4" D	4
#64-0818	Sun City Medium	4
Bottom Row		
#64-0272	Chestnut Round w/ No Show Casters	8
#64-0271	Natural Round w/ No Show Casters	8
#64-0268	Round Natural Wood	8
#64-7007	Round Aluminum, Black	8
#64-7005	Round Aluminum, Silver	8
#64-0902	Round Stone	4
	Caddy Display Pallet & Accessories	1
		136
#PC5000POG	Without display stand	



#PC5000
Assorted Plant Caddy Display
 46.5"W x 31"D x 77"H



BIRDBATHS



ADD ELEGANCE & FUNCTION TO ANY GARDEN WITH OUR RANGE OF FIBER CLAY BIRDBATHS.

- Our full Fiber Clay birdbaths are a favorite with our customers!
- Easy-to-use and move throughout the garden
- We recommend storing in an enclosed area or indoors during cold temperatures
- Being lightweight is an advantage, but if a heavier option is needed, fill the standard size base with sand to create more stabilization
- Top and base simply screw together, creating a tight-locking fit
- Available with full fiber clay base in standard or low profile height or pair the tops with a variety of decorative bases



OUR BEST-SELLING FIBER CLAY BIRDBATH IN A SHORTER SIZE!

- Our full Fiber Clay birdbaths in a shorter size!
- Made of durable fiber clay, making the birdbaths impact-resistant
- 2.5 inch deep bowl holds the perfect amount of water
- Easy-to-use and move throughout the garden
- We recommend storing in an enclosed area or indoors during cold temperatures
- Easy 3-piece threaded construction

1

#4-1892 Short Cool Gray Fiber Clay Birdbath

Gloss bowl and rim w/matte base
19"D x 7.5"H, 6.5 lbs.



3

#4-1890 Short Charcoal Sand Fiber Clay Birdbath

Semi-gloss bowl and rim w/matte base
19"D x 7.5"H, 6.5 lbs.



2

#4-1889 Short Hunter Green Fiber Clay Birdbath

Gloss bowl and rim w/matte base
19"D x 7.5"H, 6.5 lbs.



4

#4-1891 Short Azure Blue Fiber Clay Birdbath

Gloss bowl and rim w/matte base
19"D x 7.5"H, 6.5 lbs.



Actual product color may vary from the images shown, due to dye lot changes



LIGHTWEIGHT,
EASY-TO-USE,
DURABLE,
AND IMPACT
RESISTANT!

- Made of 70% Clay, 25% Plastic, and 5% Fiber. This provides more durability over time, and makes it less fragile than full clay birdbaths.
- Easy to use and move throughout the garden
- Top and base simply screw together, creating a tight-locking fit
- Fill base with sand or gravel to add weight and stability
- We recommend storing in an enclosed area or indoors during cold temperatures



1



3



2



4



1 #4-1900 Kale Green Fiber Clay Birdbath
Gloss bowl and rim w/matte base
Total: 19"D x 24"H
21"H base, 8 lbs.



3 #4-1895 Cool Gray Fiber Clay Birdbath
Gloss bowl and rim w/matte base
Total: 19"D x 24"H
21"H base, 8 lbs.



2 #4-1894 Azure Fiber Clay Birdbath
Gloss bowl and rim w/matte base
Total: 19"D x 24"H
21"H base, 8 lbs.



4 #4-1896 Terra Cotta Fiber Clay Birdbath
Semi-gloss bowl with matte rim/base
Total: 19"D x 24"H
21"H base, 8 lbs.



SLEEK-STYLISH
NEW BASE WITH
3 PIECE QUALITY
CONSTRUCTION

Piece 1:
Bowl

Threaded top
for better fit

Piece 2:
Tower

Threaded base
for better fit

Piece 3:
Base



5



7



6



8



5 #4-8172
Antique Brown Fiber Clay Birdbath
Gloss bowl and rim w/matte base
Total: 19"D x 24"H
21"H base, 8 lbs.



7 #4-8180
Red/Charcoal Fiber Clay Birdbath
Semi-gloss bowl with matte rim/base
Total: 19"D x 24"H
21"H base, 8 lbs.



6 #4-8181
Hunter Fiber Clay Birdbath
Gloss bowl and rim w/matte base
Total: 19"D x 24"H
21"H base, 8 lbs.



8 #4-8177
Charcoal Sand Fiber Clay Birdbath
Semi-gloss bowl with matte rim/base
Total: 19"D x 24"H
21"H base, 8 lbs.



FILL BASE WITH GRAVEL OR
SAND FOR ADDED STABILITY

Actual product color may vary from the images shown, due to dye lot changes

MIX & MATCH BIRDBATHS

- Choose from eleven styles that pair nicely with our deluxe metal tube bases
- Made of 70% clay, 25% plastic, and 5% fiber to provide more durability over time, and less fragile than full clay birdbaths
- Each birdbath has a smooth gloss basin for easy clean up and to reduce staining; also provides UV protection
- 2.5" deep; holds 2 gallons of water



1 #4-1894T
Azure Bowl
Gloss bowl w/gloss rim; 19"D; 5 lbs



4 #4-1900T
Kale Green Bowl
Gloss bowl w/gloss rim; 19"D; 5 lbs.



7 #4-8172T
Antique Brown Bowl
Gloss bowl w/gloss rim; 19"D; 5 lbs.



2 #4-1895T
Cool Gray Bowl
Gloss bowl w/gloss rim; 19"D; 5 lbs.



5 #4-1761T
Black/Red Design Rim Bowl
Semi-gloss bowl w/matte rim; 19"D; 5 lbs.



8 #4-8177T
Charcoal Sand Design Rim Bowl
Semi-gloss bowl w/matte rim; 19"D; 5 lbs



3 #4-1896T
Terra Cotta Design Rim Bowl
Semi-gloss bowl w/matte rim; 19"D; 5 lbs.



6 #4-1763T
White/Brown Design Rim Bowl
Semi-gloss bowl w/matte rim; 19"D; 5 lbs.



9 #4-8180T
Red/Charcoal Design Rim Bowl
Semi-gloss bowl w/matte rim; 19"D ; 5 lbs



METAL BIRDBATH BASES



10



11



12



- Works with all of our Fiber Clay Birdbath Bowl options
- Base has four prongs to keep bowl in place and a locking mechanism to secure the legs in place



10 #4-8181T
Hunter Green Bowl
Gloss bowl w/gloss rim; 19"D; 5 lbs



13 #46-0753
Deluxe Antique Bronze Metal
Birdbath Base



14 #46-0753BLK
Deluxe Black Metal
Birdbath Base



11 #4-8160T
Bright Green/Gold Design Rim Bowl
Semi-gloss bowl; 19"D; 5 lbs



12 #4-8170MC
Mixed Case of Bowls

- A total of 8 Birdbath Bowls
- Includes 1 of each: 4-1894T, 4-1895T, 4-1896T, 4-8172T, 4-8177T, 4-8180T, 4-8181T, 4-8160T

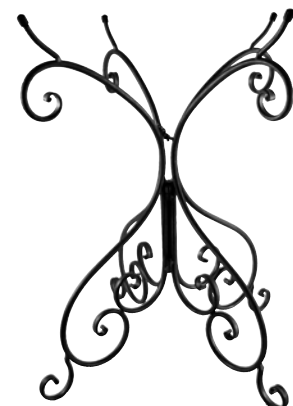

Actual product color may vary from the images shown, due to dye lot changes

CREATE YOUR OWN DISPLAY

CHOOSE THE BIRDBATH COLORS AND BASES THAT WILL BEST SUIT YOUR CUSTOMERS AND CREATE YOUR OWN DOUBLE-SIDED CUSTOM DISPLAY.

A NEW WAY TO ORDER OUR BEST-SELLING BIRDBATH COLLECTION—CUSTOMIZE YOUR OWN DISPLAY!

STEP 1: CHOOSE THE BASES

Add 6 total cases (24 total) of any combination of birdbath base.

STEP 2: CHOOSE UP TO 6 COLORS

The double-sided bird bath display easily holds up to 6 colors of bird bath tops. Choose 6 total cases (24 total) of your favorite colors to customize your own display.

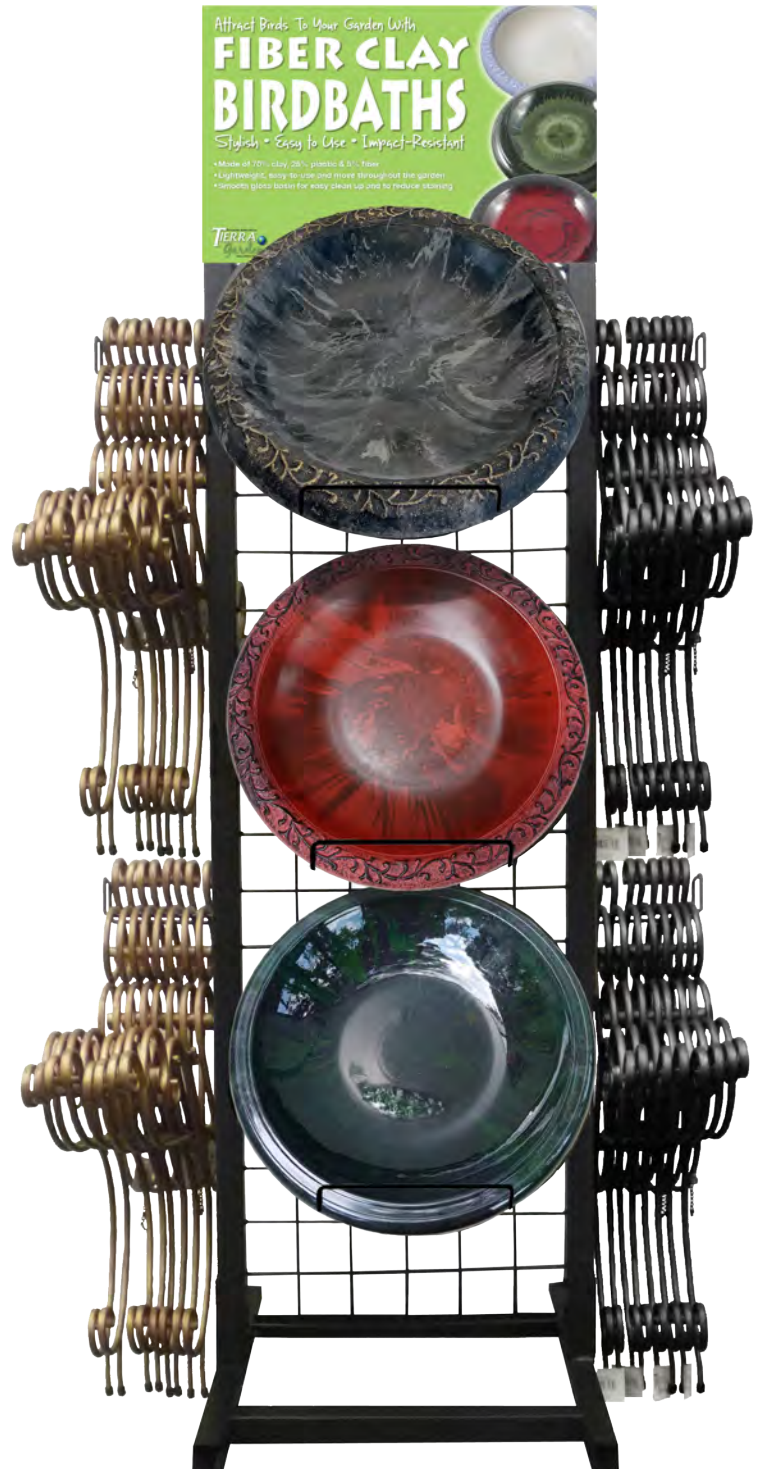
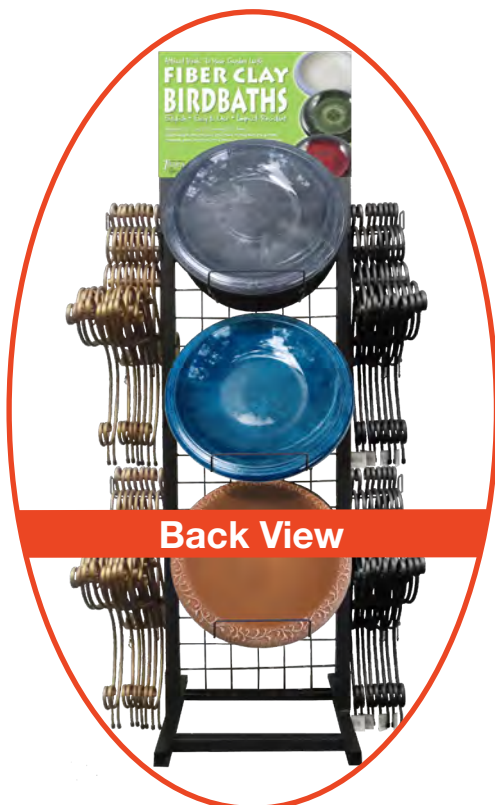

56-1706 Fiber Clay Birdbath Display Stand
34"W x 22"D x 79"H

**DESIGN
YOUR
OWN!**

STEP 1: CHOOSE THE BASES



46-0753
Antique Bronze



46-0753BLK
Black

STEP 2: CHOOSE UP TO 6 COLORS



4-1894T



4-1895T



4-1896T



4-1900T



4-1761T



4-1763T



4-8172T



4-8177T



4-8180T



4-8181T



4-8160T

STEP 1: CHOOSE 24 TOTAL BASES

Part #	Description	CS QTY
#46-0753	Deluxe Metal Antique Bronze Base	4
#46-0753BLK	Deluxe Metal Black Base	4

STEP 2: CHOOSE 24 TOTAL TOPS

#4-1894T	Azure Blue Bowl	4
#4-1895T	Cool Gray Bowl	4
#4-1896T	Terra Cotta Bowl	4
#4-1900T	Kale Green Bowl	4
#4-1761T	Black/Red Rim Bowl	4
#4-1763T	White/Brown Rim Bowl	4
#4-8172T	Antique Brown Bowl	4
#4-8177T	Charcoal Sand/Gold Rim Bowl	4
#4-8180T	Red/Charcoal Rim Bowl	4
#4-8181T	Hunter Green Bowl	4
#4-8160T	Bright Green/Gold Design Rim Bowl	4

STEP 3: DON'T FORGET THE DISPLAY

#4-FBDS	Display Header Sign	1
#56-1706	Black Display Stand (1/2 price)	

Create Your Own Display

- 24 Total Birdbath Tops
- 24 Total Birdbath Bases
- 1 Display Stand With Header
(Half Price with Purchase of 24 Tops & 24 Bases)

CLASSIC FIBER CLAY DISPLAY

MAKE ORDERING EASY WITH THIS DISPLAY THAT INCLUDES A MIX OF OUR STANDARD AND LATEST ADDITION BOWL OPTIONS ALONG WITH DELUXE ANTIQUE BRONZE AND BLACK METAL BASES

- Perfect double-sided display for your store!
- Comes with 24 Birdbath Bowls (colors listed in table below) and 24 Metal Bases (12 Bronze & 12 Black)

#FB2000 Classic Fiber Clay Display

Part #	Description	QTY
#4-8177T	Charcoal Sand Bowl	4
#4-8180T	Red/Charcoal Rim Bowl	4
#4-8181T	Hunter Green Bowl	4
#4-1895T	Cool Gray Bowl	4
#4-1894T	Azure Blue Bowl	4
#4-1896T	Terra Cotta Bowl	4
#46-0753	Deluxe Metal Antique Bronze Base	12
#46-0753BLK	Deluxe Metal Black Base	12
#4-FBDS	Display Header Sign	1
#56-1706	Black Display Stand (1/2 price)	1
		48
#FB2000POG	Without display stand	48

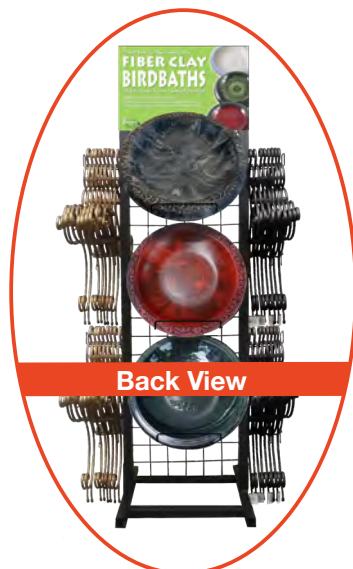

#FB2000 Fiber Clay Birdbath Display
34"W x 22"D x 79"H



CARTS



CARTS DESIGNED FOR YOUR ENVIRONMENT

When choosing a TDI Cart, you should give the matter some thought. This faithful servant will be around for many years to come!

Zinc plated frames with protective clear coat finish help ensure a long-lasting appearance. Wheels and casters have been adapted to suit every type of surface and weather condition, and they are not welded to the frame - which means if they should wear out, they can easily be replaced. The plastic handles, baby seat flap, safety strap, and metal baskets are also replaceable, extending the life of your cart.

All TDI Carts can be nested together, whether the top shelf is up or down, making storage extremely easy and efficient. And our carts are suitable for any garden center, nursery, and hardware store.

But most importantly, our large capacity and load surface shopping carts will help to maximize your profits. Invest in the best and buy the biggest...because when the cart is full, the shopping (and your profit) stops!



Buying carts is an investment for your business,
so be confident by making an informed decision.

SELECTING THE RIGHT CART IS KEY IN PROVIDING THE BEST CUSTOMER EXPERIENCE AND IN MAXIMIZING PROFITABILITY.

LET TDI HELP!

Answer these six simple questions then review the individual product pages to identify the carts that will work best for you. We're happy to assist! Just call your local Sales Representative or TDI Headquarters at 800.992.1220.

1. What is your main business?
 - Perennials & Annuals (require max floor loading capacity)
 - Trees & Shrubs (require short upper shelf or wagon)
 - Landscaping Products (require heavy weight capacity)
2. What kind of terrain do you have?
 - Hilly (use carts with brakes)
 - Flat (carts with brakes aren't needed)
3. Where will the carts be used?
 - Inside Only (use of Small wheels are OK)
 - Inside and Outside
 - Outside Only
4. How wide are your aisles?
 - Narrow (use Standard Frame Carts)
 - Wide
5. What type of carts are you looking for?
 - Wagons
 - Shelf Carts
 - Nestable/Stackable Carts
6. What type of surfaces do you have?
 - Concrete (6" wheels)
 - Asphalt (6" wheels)
 - Paving Stone (6" or 8" rubber or foam wheels)
 - Compacted Stone Dust (8" rubber or foam)
 - Coarse Gravel (8", 10", or 16" foam)
 - Mulch or Mud (10" or 16" foam)

HELPFUL HINT!

Plan to provide 1.2 carts for every parking space available at your business.

For example, if you have 50 parking spaces, we recommend purchasing 60 carts.

The icons below will help you identify the correct wheel type for each ground surface.

These are also shown on the individual product pages.



Tiled or Smooth
Concrete Floor



Paving Stone, Compacted
Gravel, or Compacted
Stone Dust



Loose Gravel,
Rough Terrain



Coarse Gravel,
Mulch, or Mud



All Surfaces

12 REASONS TDI CARTS ARE BETTER

- 1 Plastic handles can be replaced.
- 2 Baby seat is ideal for children, purses, or small, delicate items.
- 3 Easier to maneuver because of the narrow frame with a large loading capacity.
- 4 Additional clear lacquer over the zinc-plated metal ensures the carts will look new for many years.
- 5 Foldable upper shelves when more space is required on the lower shelf.
- 6 Large cubic loading capacity is 30% larger than similar carts.
- 7 Hooks to hold baskets or flower bags.
- 8 Nestable with shelves up or down for greater storage capacity.
- 9 Carts available with ideal width for narrow aisles.
- 10 Long bottom shelf for greater loading capacity.
- 11 Large rims retain pots on the shelves.
- 12 Select from multiple tire options to accommodate the surface types and terrain at your business:
 - 6" and 8" Rubber Flat Proof
 - 8", 10", or 16" Foam Flat Proof*Wheels are not welded.*



tdi carts & trunk liners™

WHAT CUSTOMERS ARE SAYING ABOUT TDI CARTS!

THESE CARTS INCREASED OUR SALES BY 28%!

Ned Wilson
Wilson's Garden Center

"At Wilson's Garden Center in Newark, Ohio, we used UPC tracking on every single TDI Cart to register every sale. The result was stunning! TDI Carts generated 28% more sales per cart compared to the other cart that we were using."



CUSTOMERS JUST KEPT LOADING FLAT, AFTER FLAT, AFTER FLAT!

Jerry Dill
Dill's Greenhouse

"The Derco 3-Shelf Cart has such a large loading capacity that each customer will buy more! Our cashiers can clearly see that the customers buy more by completely loading the three decks. This cart is so versatile that in the middle of the season, we can easily make a single or double decker cart by taking out the extra shelves. We are so happy with the result that we will definitely purchase more TDI 3-Shelf Carts!"



THE BOTTOM LINE IS THE BEST
THING ABOUT THESE CARTS...
WE HAVE DOUBLED OUR SALES SINCE
WE STARTED USING TDI CARTS!

Cole Webster & Jim Webster
The Barn Nursery

"These carts are all we use...got everything (red wagons, wooden carts, etc.) off the property!"

"Customer sales are directly related to cart space and TDI Carts give us lots of space!"

"The staff and customers love these amazing carts"

"Cheapest carts we have ever bought based off of increased sale and longevity of the carts. What a bargain!"



Watch full video
testimonial



BIG THINGS COME IN SMALLER PACKAGES.

TDI's Standard Frame Carts provide a smaller frame, but lots of load surface capacity. They are easy to maneuver, come with a child seat, and effortlessly glide through smaller spaces, narrow aisles, and can be used on paved or rough terrain - just select the right wheel for your business. They are light in weight with a heavy-duty construction.



Tiled or smooth concrete floor



Paving stone, compacted gravel
or duststone concrete floor



Loose gravel, rough terrain



SAVE SPACE!
Carts nest every 9.25" with
the shelf up or down.



NESTABLE SHELF
(up or down)

FEATURES & SPECIFICATIONS

- Easy to maneuver, great for narrow aisles
- Child seat included
- Wheel nesting guides included
- Zinc plated plus a protective clear coat finish that will last many years
- No assembly required
- Overall dimensions: — 38"L x 23.75"W x 42"H
- Shelf dimensions (O.D.): — Top: 19"W x 28"L — Bottom: 18.5"W x 36"L
- Shelf Spacing: — 17.25"W
- Capacity: — 800 lbs load capacity — 9 sq. ft. load surface



MODEL #	WHEEL TYPE	LOAD SURFACE	WEIGHT	TERRAIN
#35222	6" Rubber Flat Proof	9 sq. ft.	74lbs	
#35224	8" Rubber Flat Proof	9 sq. ft.	90lbs	
#35227	8" Foam Flat Proof	9 sq. ft.	85lbs	

Six Standard Frame Carts fit on one pallet. For shipping purposes, order in full pallets to help minimize freight costs.

IT'S LARGE AND IN CHARGE

Go with our larger, 12.5 sq. ft. Large Frame Cart to increase your average order size. Some customers have even experienced up to a 28% increase!

Choose the short shelf to better accommodate taller plants and shrubs. Either way, it's a winner!

SAVE SPACE WITH NESTABLE SHELF!
Carts nest every 11.5" with the shelf up or down.



Tiled or smooth concrete floor



Paving stone, compacted gravel or duststone concrete floor



Loose gravel, rough terrain













Coarse gravel, mulch or mud

FEATURES & SPECIFICATIONS











- Easy to maneuver
- Choose between a Short Upper shelf, great for taller plants and shrubs, or a Long Upper shelf which provides more loading capacity to increase sales
- Child seat included
- Wheel nesting guides included
- Zinc plated plus a protective clear coat finish that will last many years
- 800lbs load capacity
- Load surface of 10.23 or 12.5 sq. ft.
- No assembly required
- Overall dimensions:
 - 48"L x 26.25"W x 44"H
- Shelf dimensions (O.D.):
 - Top Long: 34.75"W x 20.5"H
 - Top Short: 20.75"W x 20.5"H
 - Bottom: 41"W x 20.75"H
- Capacity:
 - 800 lbs load capacity
 - 10.23 sq. ft. load surface (short)
 - 12.5 sq. ft. load surface (long)



SHORT UPPER SHELF

MODEL #	WHEEL TYPE	LOAD SURFACE	WEIGHT	TERRAIN
#35229	6" Rubber Flat Proof	10.23 sq. ft.	90lbs	
#35230	8" Rubber Flat Proof	10.23 sq. ft.	100lbs	 
#35233	8" Foam Flat Proof	10.23 sq. ft.	95lbs	  
#35234	10" Foam Flat Proof	10.23 sq. ft.	99lbs	   

LONG UPPER SHELF

MODEL #	WHEEL TYPE	LOAD SURFACE	WEIGHT	TERRAIN
#35244	6" Rubber Flat Proof	12.5 sq. ft.	98lbs	
#35235	8" Rubber Flat Proof	12.5 sq. ft.	104lbs	 
#35238	8" Foam Flat Proof	12.5 sq. ft.	94lbs	  
#35237	10" Foam Flat Proof	12.5 sq. ft.	106lbs	   

Four Large Frame Carts fit on one pallet. For shipping purposes, order in full pallets to help minimize freight costs.

THE BRAKES ARE ALWAYS ON

Our brake cart will never get away from your customers on slopes or hills. Simple to use, just press the handle down to release the brakes. And it works under the worst of conditions, including mud, water, and snow!



SAVE SPACE WITH
NESTABLE SHELF!
Carts nest every
15" with the shelf
up or down.

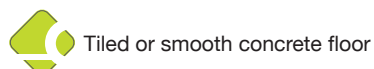

Tiled or smooth concrete floor



Paving stone, compacted gravel
or duststone concrete floor

THE CARTS ARE DURABLE, THE FINISH IS BUILT TO LAST, AND THE CUSTOMERS LOVE THEM...AND WE LOVE HOW MUCH THEY LOAD INTO THEM! – Joe Blackshere, Westlake Ace Hardware

"TDI Brands has been a pleasure to do business with. Their team of experts have made our cart buying experience easy. The carts we most recently purchased include an automatic brake which provides us a sense of security in our stores that have slopes out in our parking lots. The cart does not move unless the user has a hold of the handle. This allows customers to shop freely without keeping a hand (or more dangerously a foot) on their cart. The carts are durable, the finish is built to last, and the customers love them...and we love how much they load into them!"

FEATURES & SPECIFICATIONS

- Easy to maneuver
- Choose between a Short Upper shelf, great for taller plants and shrubs, or a Long Upper shelf which provides more loading capacity to increase sales
- Brakes keep cart from rolling on inclines
- Brake handle is conveniently located on top of push handle
- Wheel nesting guides included
- Basket included for small items (no child seat)
- Large rims on shelves prevent pots from falling off
- Hooks on upper shelf for hanging plants
- Zinc plated plus a protective clear coat finish that will last
- No assembly required
- Available only with 8" Rubber Flat Proof wheels
- Overall dimensions:
 - 48"L x 26.25"W x 44"H
- Shelf dimensions (O.D.):
 - Top Long: 34.75"W x 20.5"H
 - Top Short: 20.75"W x 20.5"H
 - Bottom: 41"W x 20.75"H
- Capacity:
 - 800 lbs load capacity
 - 10.23 sq. ft. load surface (short)
 - 12.5 sq. ft. load surface (long)

tdi carts & trunk liners™

SHORT UPPER SHELF

MODEL #	WHEEL TYPE	LOAD SURFACE	WEIGHT	TERRAIN
#35240	8" Rubber Flat Proof	10.23 sq. ft.	108lbs	

LONG UPPER SHELF

MODEL #	WHEEL TYPE	LOAD SURFACE	WEIGHT	TERRAIN
#35245	8" Rubber Flat Proof	12.5 sq. ft.	113lbs	

Four Brake Carts fit on one pallet. For shipping purposes, order in full pallets to help minimize freight costs.

Carts are FOB Jasper, Indiana

A skid fee will be added to the FOB freight charges

 Derco Patented Designs

IT'S TRULY ONE OF A KIND

Our 3-Shelf Cart is the only nestable, 3-Shelf cart in the industry!

So not only do you increase sales with its enormous 16.64 sq. ft. of loading surface, you also save space by nesting the carts when they are not in use.

The two upper shelves can be easily removed, plus the rims prevent pots from falling. With the extra hooks for hanging baskets and a baby seat with a safety belt, this cart has it all. Not to mention, it has been proven to increase sales. Get your own 3-Shelf Cart success today!

SAVE SPACE!
Carts nest every 15" with the shelves down or 17.5" with the shelves up.



Versatile, middle shelf can be removed when needed.



CUSTOMIZE THIS CART THROUGHOUT THE SEASON!

Use all three shelves for annuals, then take out the middle shelf for taller perennials.



Tiled or smooth concrete floor



Paving stone, compacted gravel or duststone concrete floor



Loose gravel, rough terrain



Coarse gravel, mulch or mud

THE BIGGER YOUR CART, THE BIGGER YOUR PROFIT

– Timothy H. Wolfe, Lake Street Garden Center

"The other day I saw two women shopping and using one of the new TDI 3-Shelf Carts we had recently purchased. The women had loaded the bottom shelf with some concrete products, and the top and middle shelves were full with plants as well. The cart was so loaded it took both women to push it to the register! At first when I saw this I was concerned that the shelves might not handle all the weight. But they did! The value of the product on the cart that day was almost \$1000.00!"



FEATURES & SPECIFICATIONS

- Two foldable upper shelves when more space on the lower deck is required
- Large rims on shelves prevent pots from falling off
- Hooks on upper shelves for hanging plants
- Child seat included
- Wheel nesting guides included
- Zinc plated plus a protective clear coat finish that will last
- No assembly required
- Overall dimensions:
 - 47.5"L x 25.5"W x 43"H
- Shelf dimensions (O.D.):
 - Top: 36"W x 20.5"H
 - Middle: 35.25"W x 20.5"H
 - Bottom: 44"W x 20.75"H
 - Space Between Shelves: 13.5"
- Capacity:
 - 800 lbs load capacity
 - 16 sq. ft. load surface

BUY THE BIGGEST! HOLDS 13 FLATS!!



MODEL #	WHEEL TYPE	LOAD SURFACE	WEIGHT	TERRAIN
#35259	6" Rubber Flat Proof	16.64 sq. ft.	113lbs	
#35265	8" Rubber Flat Proof	16.64 sq. ft.	124lbs	
#35268	8" Foam Flat Proof	16.64 sq. ft.	125lbs	
#35272	10" Foam Flat Proof	16.64 sq. ft.	124lbs	

Three 3-Shelf Carts fit on one pallet. For shipping purposes, order in full pallets to help minimize freight costs.

Carts are FOB Jasper, Indiana

A skid fee will be added to the FOB freight charges

Derco Patented Designs

WHERE WILL IT TAKE YOU?

It's the go anywhere, load anything, easy to maneuver, nestable All Terrain cart.

Large no-flat, foam wheels allow the cart to accommodate all types of terrain. It's perfect for businesses with rock or gravel pathways.

tdi carts & trunk liners™

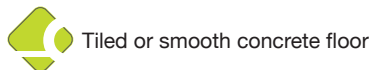

Tiled or smooth concrete floor



Paving stone, compacted gravel
or duststone concrete floor



Loose gravel, rough terrain



Coarse gravel, mulch or mud

FEATURES & SPECIFICATIONS

- Easy to maneuver
- Comes standard with no-flat, foam tires
- Large rims on shelves prevent pots from falling off
- Hooks on upper shelf for hanging plants
- Child seat included
- Zinc plated plus a protective clear coat finish that will last many years
- Wheel nesting guides included
- No assembly required

- Overall dimensions:
 - 55”L x 31.5”W x 42”H
- Shelf dimensions (O.D.):
 - Top: 20.75”W x 24.5”H
 - Bottom: 50.5”W x 24.5”H
- Capacity:
 - 1,200 lbs load capacity
 - 10 sq. ft. load surface (no shelf)
 - 13.5 sq. ft. load surface (short shelf)

SAVE SPACE WITH
NESTABLE SHELF!
Carts nest every 19.5” with
the shelf up or down.



(All Terrain Not Pictured)

REPLACEMENT WHEELS FOR ALL TERRAIN CARTS



#35254
10” Front Wheel w/Bearings
For All Terrain Cart



#35253
16” Rear Wheel w/Bearings
For All Terrain Cart



#35252
Yoke for Front Wheel
For All Terrain Cart



#35255
Yoke for Rear Wheel
For All Terrain Cart

SHORT UPPER SHELF

MODEL #	WHEEL TYPE	LOAD SURFACE	WEIGHT	TERRAIN
#35283	16” & 10” Foam Flat Proof	13.5 sq. ft.	130lbs	

Three All Terrain Carts fit on one pallet. For shipping purposes, order in full pallets to help minimize freight costs.

Carts are FOB Jasper, Indiana

A skid fee will be added to the FOB freight charges

Derco Patented Designs

HEAVY DUTY & READY TO GET THE JOB DONE

These heavy-duty carts are perfect for all your Garden Center and Nursery needs. And the flexible options let you customize it not only for your business, but also for your customers' needs!



Tiled or smooth concrete floor



Paving stone, compacted gravel or duststone concrete floor



Loose gravel, rough terrain













Coarse gravel, mulch or mud











FEATURES & SPECIFICATIONS

- Zinc plated plus a protective clear coat finish that will last many years
- Brake models available with U-Handle
- Optional Basket and Shelf, as well as replacement parts
- Overall Dimensions: 48"L x 30"W

U-HANDLE CARTS WITHOUT BRAKES

MODEL #	WHEEL TYPE	LOAD SURFACE	WEIGHT	TERRAIN
#35270-1	8" Rubber Flat Proof	1200lbs	100lbs	 
#35274-1	8" Foam Flat Proof	1200lbs	96lbs	   
#35277-1	10" Foam Flat Proof	1200lbs	95lbs	   

U-HANDLE CARTS WITH BRAKES

MODEL #	WHEEL TYPE	LOAD SURFACE	WEIGHT	TERRAIN
#35271-1	8" Rubber Flat Proof	1200lbs	108lbs	 
#35278-1	8" Foam Flat Proof	1200lbs	106lbs	   
#35279-1	10" Foam Flat Proof	1200lbs	112lbs	   

NURSERY CART ACCESSORIES

MODEL #	DESCRIPTION	LOAD CAPACITY	WEIGHT
#30135	Basket	50lbs	6.6lbs
#30217	Shelf	50lbs	6.6lbs
#212425	Repl. U-Handle w/Brake	NA	6lbs
#212425R	Repl. U-Handle No Brake	NA	6lbs

Four Nursery Carts fit on one pallet. For shipping purposes, order in full pallets to help minimize freight costs.

EXTEND THE LIFE OF YOUR CARTS!

If the cart is working for you, it's likely going to get some wear and tear, especially on the handles and child seats. Don't worry, we offer replacement parts for these highly used areas so you can keep your carts looking new year after year.



Plastic Cart Handles

- Available in 13.75"L or 16.75"L
- Easy to replace



#212400
16.75"L Plastic Handle
 Fits Brake Cart Only
 0.2lbs

#212401
13.75"L Plastic Handle
 Fits Standard Frame, Large Frame, 3-Shelf & All Terrain Carts
 0.2lbs



Seat Belts for Carts (Child Straps)
#35330
 0.5lbs



Plastic Plates for Baby Seat
#30134
 0.25lbs

Replacement Wheels

PART #	DESCRIPTION	CAPACITY	WEIGHT	CASE QTY
30188	6" rubber flat proof wheel, w/2.25" hub & 0.5" BB	300lbs	4.4lbs	10
30166	Swivel yoke for 6" wheels with hardware	NA	3.75lbs	20
30167	Fixed yoke for 6" wheels with hardware	NA	2.9lbs	20

6" Rubber Flat Proof

Asphalt or
concrete floors



PART #	DESCRIPTION	CAPACITY	WEIGHT	CASE QTY
30119	8" rubber flat proof wheel, w/3" hub & 0.5" BB	400lbs	4.4lbs	8
30182	Swivel yoke for 8" wheels with hardware	NA	3.75lbs	20
30184	Fixed yoke for 8" wheels with hardware	NA	2.9lbs	20

8" Rubber Flat Proof

Paving stone,
compacted gravel, or
compacted duststone



PART #	DESCRIPTION	CAPACITY	WEIGHT	CASE QTY
30120	8" foam flat proof wheel, 3.25" hub & 0.5" BB	250lbs	3lbs	8
30182	Swivel yoke for 8" wheels with hardware	NA	3.75lbs	20
30184	Fixed yoke for 8" wheels with hardware	NA	2.9lbs	20

8" Foam Flat Proof

Loose gravel and
rough terrain



PART #	DESCRIPTION	CAPACITY	WEIGHT	CASE QTY
30142	10" foam flat proof wheel, 4.0" hub & 0.5" BB	250lbs	5lbs	5
30180	Swivel yoke for 10" wheels with hardware	NA	4.2lbs	20
30181	Fixed yoke for 10" wheels with hardware	NA	3lbs	20

10" Foam Flat Proof

Coarse gravel,
mulch, or mud



Cart Care Guidelines

Regular maintenance inspections and repairs will extend the life of your shopping carts.

1. KEEP CARTS CLEAN

Clean all cart surfaces with mild soap and water. Use citrus degreaser on any grease/oil deposits. Rinse well with water.

2. INSPECT/ADJUST

Carefully check all parts of the frame, wheels, yokes, shelves, basket, and seat belt for damage, wear, and/or rust. Tighten any loose bolts. Check and adjust brakes if necessary.

3. LUBRICATE

Using a spray lubricant or light grease/oil, lube all swivels, bearings, and pivot points and grease fittings. Spray lube inside any frame tubing weep holes to help prevent rust.

4. REPAIR/REPLACE

Any worn or damaged parts should be replaced with original TDI replacement parts. See catalog for options, pricing, and model numbers.

5. TOUCH UP/PROTECT



Any rust spot or worn area can be sprayed with a light touch up of paint to make the cart look like new, and it will also make it resistant to corrosion for years. Newer carts will require a chrome (metallic) or galvanized color; older carts may require a darker color. A coating of clear lacquer is also recommended for areas that are touched up to provide further protection and shine.



tdi carts & trunk liners™

TERMS & CONDITIONS

Freight:

FOB Jasper, Indiana; a build and skid fee will be added to the FOB freight charges. This build/skid fee also applies to customer pick-up orders.

Terms:

Net 30 days (for approved accounts). MasterCard, Visa, and Discover accepted. 3.5% processing fee for all credit card payments.

Credit Terms:

To set up an account, simply call our customer service department and request a credit application or apply online (www.tdibrands.com). You will be notified when approval has been given. Overdue invoices will be assessed a 1.5% per month finance charge.

Prompt and Efficient Service:

Under normal conditions, carts and non-personalized trunk liners are shipped within 3 - 7 days. Allow 8 - 12 weeks for personalized and custom trunk liners.

Back Orders:

Items temporarily out of stock are shipped at our discretion and according to the freight terms of the original order.

Returned Goods Policy:

Returns are not accepted without prior return authorization from our Customer Care Team. The invoice number must appear on all packages. Return merchandise must be sent freight prepaid along with a copy of the invoice within 30 days of the invoice date. Returns may be subject to a 20% restocking fee. Items must be in saleable condition. TDI Brands does not issue call tags.

Shortages and Damages:

All claims must be made within 10 days of the invoice date. In the case of a damaged shipment, indicate "damaged" when signing for the package and call us immediately for further instructions. Keep the original carton and damaged merchandise until claim is resolved.

Express Limited Warranty:

Tierra-Derco International warrants to the original that any goods supplied by Tierra-Derco shall be free from defects in material and workmanship for ONE YEAR from the date of purchase. This EXPRESS LIMITED WARRANTY does NOT apply where there has been a failure of the goods due to misuse, improper assembly, neglect, accident, or normal wear and tear.

Prices and specifications subject to change without notice:

We make every attempt to hold catalog prices throughout the year. Due to fluctuations in international currency and inflation, price changes may be unavoidable. Actual color of product may vary slightly due to color variations in the printing process for trunk liners. All weights listed in the catalog are approximate.

See our entire line at
www.tdicartsandliners.com



TRUNK LINERS

TRUNK LINERS ARE ONE OF THE EASIEST AND MOST INEXPENSIVE WAYS TO SHOW YOU CARE.

Our trunk liners are larger to better fit any size vehicle, providing greater coverage and eliminating the need to use two (saving you money!).

OUR CUSTOMERS SAY IT BEST!



THESE
LINERS
HOLD UP
EXTREMELY

WELL AND IT IS SO NICE TO SEE
OUR CUSTOMERS RETURNING TO SHOP
AT MAHONEY'S WITH OUR LINERS STILL
IN THEIR CARS.

Bob Rocco
Mahoney's

"We at Mahoney's have been purchasing trunk liners from TDI Brands for a few years now. The liners from our former supplier were folded as they came off the display. Customers were inadvertently taking several liners off the display at one time, since they appeared smaller. The liners from TDI Brands are larger and come off the display as a full sheet. With the addition of the "tear here" dotted line that was added to our custom liner, we are finding there is very little waste, so our customers are actually taking fewer liners at one time. These liners hold up extremely well and it is so nice to see our customers returning to shop at Mahoney's with our liners still in their cars."

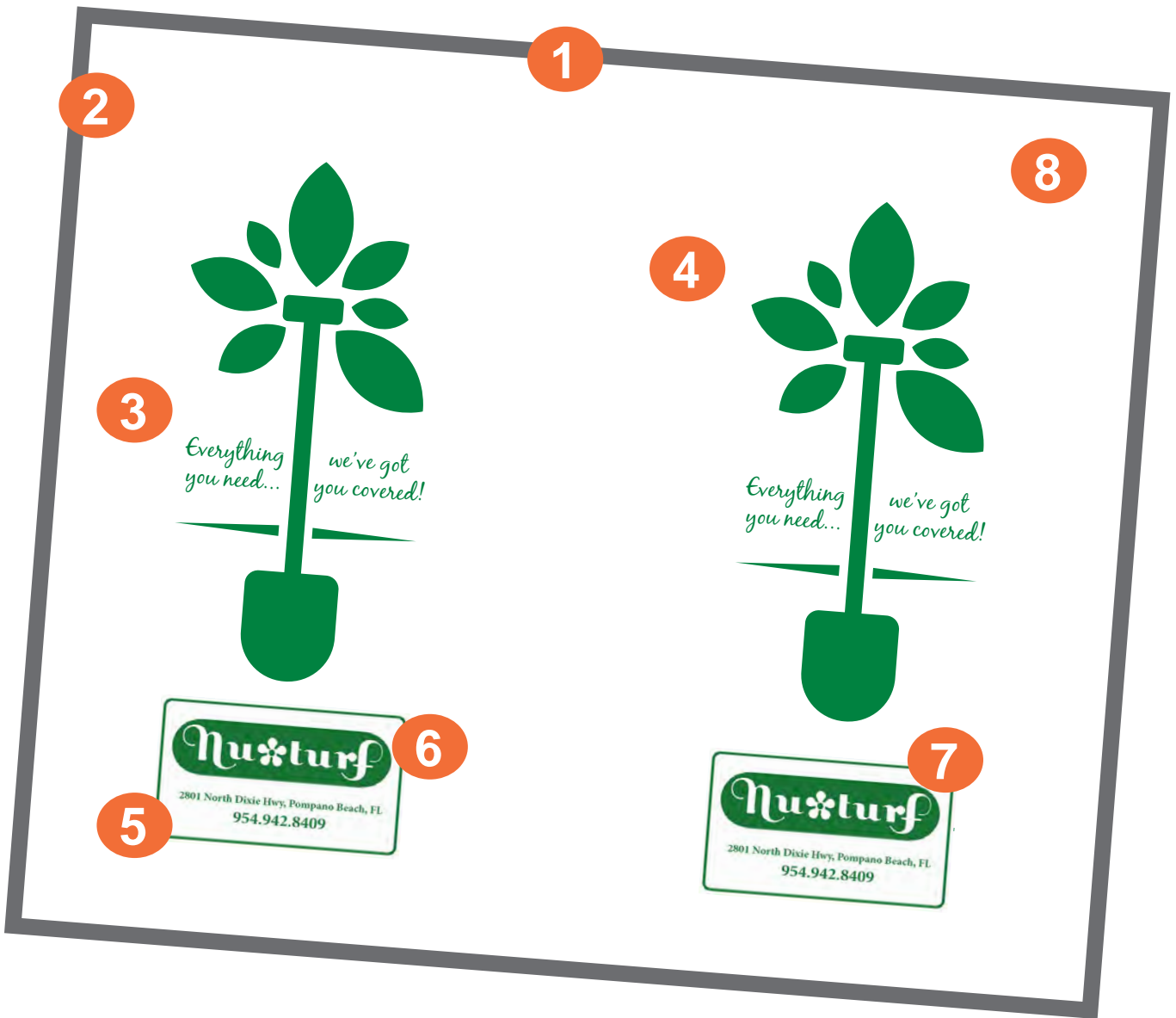

- 1 An inexpensive marketing tool!
- 2 Easy to tear perforations
- 3 Perfectly sized! Use only one per trunk! (38" x 45")
- 4 TDI's simple design enhances your company name
- 5 Works great with the available heavy-duty, polystone display
- 6 Your business name or logo is printed in over 140 square inches of space
- 7 Your company name appears twice on each sheet
- 8 1000 flat (not folded) sheets per roll reduces downtime in changing rolls

PLAIN WHITE LINERS

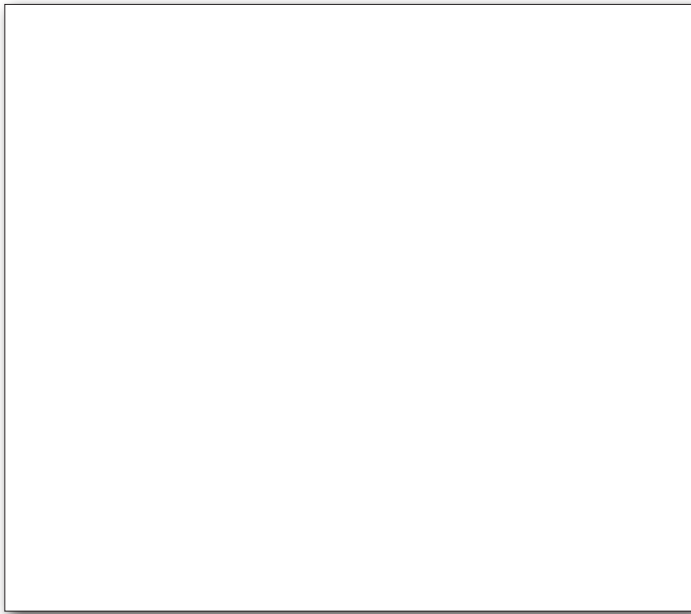

- Large 45"W x 38"H pre-cut white polyethylene sheets
- 1000 sheets per roll
- Easy to tear perforations

#18038
Plain White Liners
 FOB Jasper, IN 60 lbs

"We ran the price comparisons and found these liners to be the best value for the money."

"An easy way to differentiate ourselves from the box stores. The simple act of putting a liner in a customer's car is a huge customer service gain."

“ TDI'S PERFORATED LINERS ARE EASY TO TEAR OFF THE ROLL ”

"And the display stand makes them quick and easy to use."

PRE-PRINTED THANK YOU LINER STANDARD OR PERSONALIZED



Personalize our standard liners with your logo!



STANDARD THANK YOU LINERS:

- Large (45"W x 38"H) pre-cut white polyethylene sheets
- 1000 sheets per roll
- Easy to tear perforations
- "Thank you for shopping local!" appears twice on each sheet

#18030

Thank You Liners

FOB Jasper, IN 60 lbs

“ IT'S EASY TO SHOW CUSTOMERS YOU CARE ”

PERSONALIZED THANK YOU LINERS:

- Large (45"W x 38"H) pre-cut white polyethylene sheets
- 1000 sheets per roll
- Your logo appears twice on each sheet
- Standard green color
- +/- 10"L x 6"W" area for your logo

#18029

Personalized Liners

- Minimum of 6 rolls in standard green
- Minimum of 12 rolls in any other 1 color
- First time set up charge

FOB Jasper, IN 60 lbs

First Time Set Up Charges:

\$350 set up fee for printing plate and artwork cost
Additional charges may apply (at \$75/hour) for intense graphic work

Extended lead times may apply

*Quantity or rolls must be ordered in even numbers

“ THE LARGER SIZE SAVES US MONEY ”

PRE-PRINTED BIODEGRADABLE THANK YOU LINER STANDARD OR PERSONALIZED

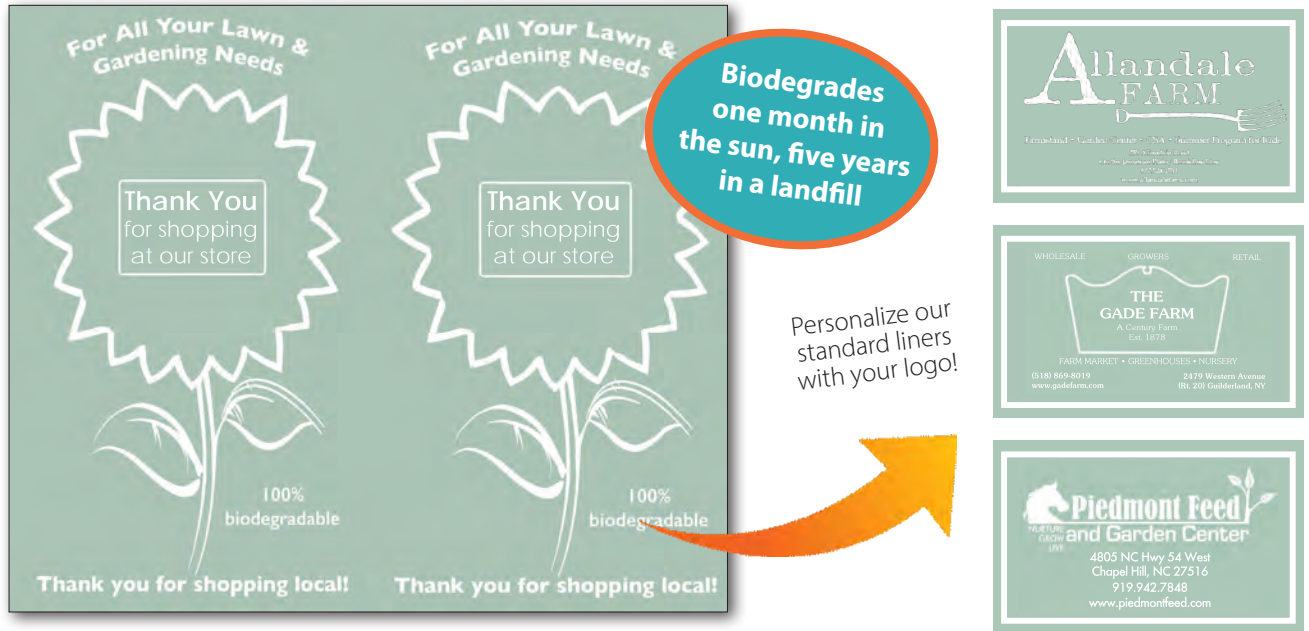

STANDARD BIO THANK YOU LINERS:

- Large (45"W x 38"H), pre-cut, semi-transparent light green polyethylene sheets with a biodegrading agent
- 1000 sheets per roll
- Easy to tear perforations
- "Thank you for shopping at our store" appears twice on each sheet (inside flower)
- Extended lead times may apply up to 6 months

#18036
BIO Thank You Liners
 FOB Jasper, IN 60 lbs

PERSONALIZED BIO THANK YOU LINERS:

- Large (45"W x 38"H), pre-cut semi-transparent light green polyethylene sheets with a biodegrading agent
- 1000 sheets per roll
- Easy to tear perforations
- +/-10"L x 6"W area for your logo
- Extended lead times may apply up to 6 months

#18037
BIO Personalized Liners

- Minimum of 6 rolls
 - First time set up charge
- FOB Jasper, IN 60 lbs

First Time Set Up Charges:

\$350 set up fee for printing plate and artwork cost
 Additional charges may apply (at \$75/hour) for intense graphic work
 Extended lead times may apply

“ SINCE THEY BIODEGRADE, WE DON'T HAVE TO WORRY ABOUT THEM ADDING TO LANDFILLS ”

“ THESE ARE THE PERFECT FIT FOR OUR GREEN IMAGE ”

CREATE A BRANDED EXPERIENCE WITH CUSTOM TRUNK LINERS!



- Large (45"W x 38"H), pre-cut polyethylene sheets
- 1000 sheets per roll
- Easy to tear perforations
- Get your liners printed any way you want!

CALL TDI FOR A SPECIAL QUOTE ON:

- Full print of your company name & logo
- More color options (additional charges apply)
- Special requirements and lead times apply

#18050-XXXXX

Custom Trunk Liners

- Min order of 16 rolls for 1 color green (348C)
- Min order of 24 rolls for all other colors

Artwork:

Provide print-ready artwork by emailing sales@tdibrands.com. First time printing plate setup and artwork fees and extended lead times, may apply. Additional charges may apply (at \$75/hour) for intense graphic work



“ WE LOVED SEEING OUR LOGO IN THE BACK OF EVERY CAR ”

“BUMPER CROP” STOCK LINER

THE PERFECT WAY TO PROMOTE THE BEST-SELLING BUMPER CROP® SOILS & PLANT FOODS!

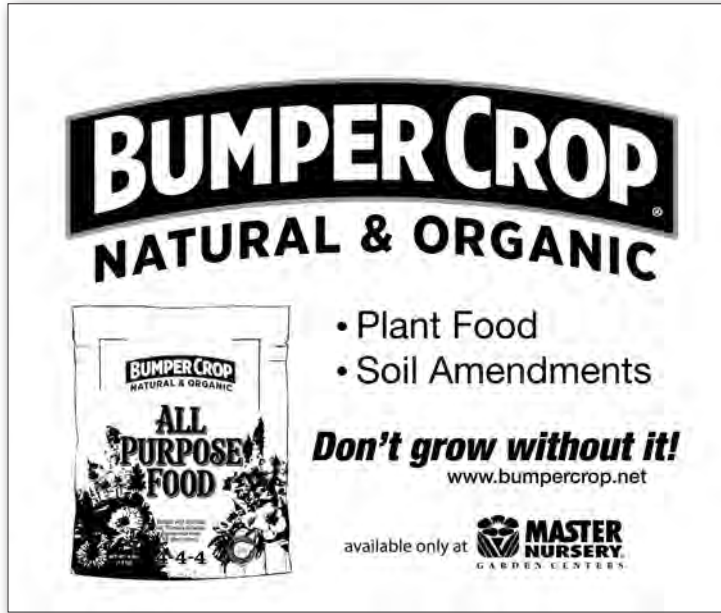

“ PROMOTE THE BEST-SELLING BUMPER CROP® SOILS & PLANT FOODS! ”

- Large 45”W x 38”H pre-cut white polyethylene sheets means customers will use only one to cover their entire trunk!
- Standard black color
- Promote the best-selling Bumper Crop® soils and plant foods
- 1000 sheets per roll
- Easy to tear perforations

#18050-15687
Master Nursery Stock Liner
 FOB Jasper, IN 60 lbs

“ KEEP LINERS ON A STAND AT THE CHECKOUT FOR YOUR CUSTOMERS TO EASILY GRAB ”



"BUMPER CROP" PERSONALIZED LINER

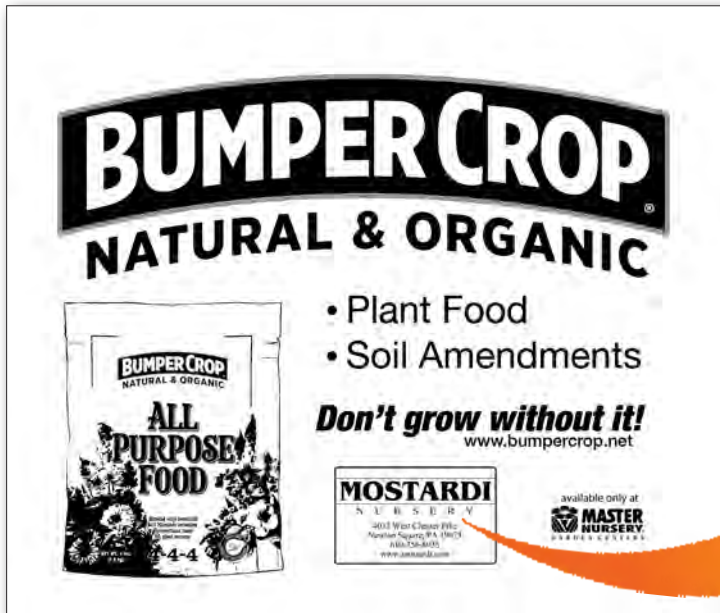

Personalize the standard liners with your logo!



PERSONALIZED BUMPER CROP LINERS:

- Large (45"W x 38"H) pre-cut white polyethylene sheets
- 1000 sheets per roll
- Your logo appears once on each sheet
- Standard black color
- +/- 10"W x 6"H area for your logo

#18050-MNXXXX

Personalized Liners

- Minimum of 6 rolls
- First time set up charge

FOB Jasper, IN 60 lbs

First Time Set Up Charges:

\$350 set up fee for printing plate and artwork cost
Additional charges may apply (at \$75/hour) for intense graphic work
Extended lead times may apply

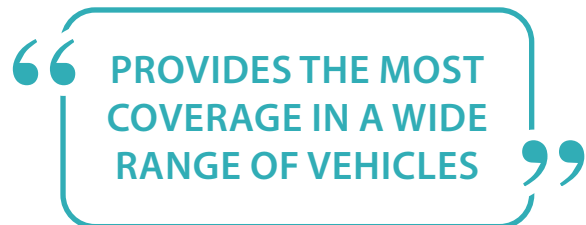

PAPER OR PLASTIC?

NOW YOU HAVE A CHOICE

WATER-RESISTANT PAPER TRUNK LINERS

FROM

tdi carts &
trunk liners™





10 BENEFITS OF WATER-RESISTANT PAPER TRUNK LINERS

- 1 Water resistant paper - strong when wet
- 2 100% compostable and biodegradable
- 3 Water-based Ink (food grade)
- 4 Greener alternative to plastic
- 5 Made in America 
- 6 6 - 8 week lead time for personalized
- 7 Can be personalized, using existing plates (20 roll min) or new plates (\$350)
- 8 Continuous roll with +/- 1,100 impressions
- 9 Cut to desired width (paper cutter)
- 10 50 lb. roll, 1,200 ft per roll approx. 380 sheets/roll (38"H x 38"W)





PRE-PRINTED WATER RESISTANT THANK YOU PAPER LINERS



- Large (38"H, 50 lb. roll) 100% compostable and biodegradable water resistant paper
- Approx 380 sheets per roll (38"Wx38"H); 1,200 ft. per roll
- Cut to desired width (paper cutter)
- "Thank you for shopping local!" appears three times on each 38"W x 38"H sheet
- Water-based Ink (food grade)
- Greener alternative to plastic
- Made in America 

#19030
Thank You Liners
FOB Jasper, IN 50 lbs



See the wet strength of our paper liners



PERSONALIZED WATER-RESISTANT PAPER LINERS



- Large (38"H, 50 lb. roll) 100% compostable and biodegradable water resistant paper
- Approx 380 sheets per roll (38"W x 38"H); 1,200 ft. per roll
- Cut to desired width (paper cutter)
- "Thank you for shopping local!" appears three times on each sheet
- Can be personalized, using existing plates (20 roll min) or new plates (\$350)
- Water-based Ink (food grade)
- Greener alternative to plastic
- Made in America 

#19029-XXXXX Personalized Liners

- Minimum of 20 rolls
- First time set up charge

FOB Jasper, IN 50 lbs

*possible 1-3 roll over/under production will be acceptable and final price adjusted accordingly

First Time Set Up Charges:

\$350 set up fee for printing plate and artwork cost
Additional charges may apply (at \$75/hour) for intense graphic work
Extended lead times may apply



CALL TDI FOR A SPECIAL QUOTE ON:

- Full print of your company name & logo
- More color options (additional charges apply)
- Special requirements and lead times apply

Artwork:

Provide print-ready artwork by emailing sales@tdibrands.com.
First time printing plate setup and artwork fees, and extended lead times, may apply.

#19050-XXXXX Custom Liners

- Minimum of 20 rolls
- First time set up charge

TRUNK LINER ROLL DISPLAY STAND

PLACE THIS ATTRACTIVE DISPLAY IN STRATEGIC LOCATIONS.
YOUR CUSTOMERS WILL APPRECIATE IT!

- Strong and heavy-duty
- Practical and functional
- Will last for many years
- Holds standard TDI rolls
- Great marketing tool!

#19050

Trunk Liner Roll Display Stand

Size: 24"L x 15"W x 58"H; 29lbs

Package: 49"L x 17"W x 5"H

FOB Jasper, Indiana

Shipping Weight: 29lbs

“
**GREAT
MARKETING
TOOL
FOR YOUR
COMPANY**
”



POLYETHYLENE TREE BAGS

THE PROFESSIONAL WAY TO PROTECT PLANTS, TREES, AND SHRUBS DURING TRANSPORT

- Prevents broken branches/leaves from falling
- Stays in the bag to protect customers' vehicles
- Protects plants from the cold and wind
- Protects trees during transportation
- Simply cut to size of tree

#998600

Polyethylene Tree Tubes on Roll

- Special Order (6-8 week delivery)

Flat: 38", Tube: 24", 2mm Thickness, 660'L

FOB Jasper, Indiana 60lbs

Call For Volume Discounts

Take a look at Stone Age Creations:



See our separate Stone Age Creations catalog for a complete product offering.

TDI Brands acquired Stone Age Creations in 2012, but since 2002, this company has been providing hand-carved, natural stone products for gardens, landscaping, and more.

From birdbaths to benches, accents to water features, Stone Age Creations delights gardeners with unique, fine quality products that have character and are a good value.

All products are hand-crafted from natural stone, as created by Mother Nature. Don't settle for anything less than the real thing.

YOUR GO-TO SOURCE FOR HAND-CRAFTED, NATURAL STONE:

- Benches
- Birdbaths
- Animals
- Fire Pits
- Accents
- Water Features
- Lanterns
- Planters
- Custom

www.StoneAgeCreations.com

STONE *Age* CREATIONS®

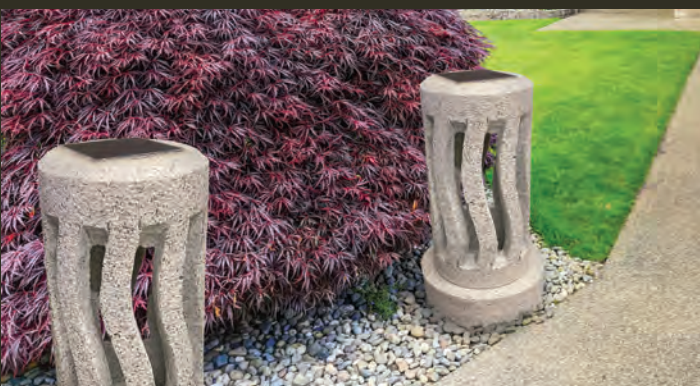

OUR FAMILY OF BRANDS



tdibrands™

ADDRESS 1000 South St. Charles Street | Jasper, IN 47546

PHONE 800.992.1220 | WEBSITE TDIbrands.com | EMAIL sales@tdibrands.com

