

 **FARM GARD®**

 **YARD GARD®**

WIRE FENCING PRODUCTS



MAT®
MIDWEST AIR TECHNOLOGIES, INC.











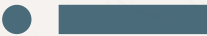



6700 WILDLIFE WAY
LONG GROVE, IL 60047

FENCING TERMINOLOGY

Gauge

- A measure of wire thickness. For example, Gauge 1 is 0.300 inches thick. Gauge 36 is .005 inches thick.
- Typical gauges found in agricultural fencing are:
 - 9 Gauge is 0.1144 inches thick
 - 10 Gauge is 0.1019 inches thick
 - 11 Gauge is .0907 inches thick
 - 12.5 Gauge is .0746 inches thick
 - 16 Gauge is .0508 inches thick
- Thicker wires are generally stronger, heavier, and more difficult to bend.

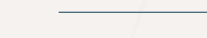
MAT's full line of products come in a variety of gauges ranging from 9 Ga. up to 27 Ga. The chart below shows you the size of each gauge (Ga.) wire used in producing MAT's Agricultural and Residential Wire Fencing.

Wire Gauge	SWG (U.S. Inch)	
9	0.1483	
10	0.1350	
11	0.1250	
12	0.1055	
12.5	0.0985	
13	0.0915	
14	0.0800	
15	0.0720	
15.5	0.0673	
16	0.0625	
19	0.0410	
20	0.0348	
23	0.0258	
27	0.0173	

Galvanization

- Protects the underlying iron or steel wire.
- The zinc coating, when intact, prevents corrosive substances reaching the underlying steel or iron wire.

Class 1 Galvanization

- Class 1 galvanized wire coating is typically found on basic barbed wire and field fence. Class 1 wire will typically last 2 to 11 years in most non-coastal climates. Zinc coating is 0.28oz/ft².

Class 3 Galvanization

- Class 3 is 2.5 times thicker than Class 1 and may last approximately 13 to 30 years before rusting in non-coastal climates. Zinc coating is 0.80oz/ft².

Annealing

- Annealing involves heating a material above its recrystallization temperature, maintaining a suitable temperature, and then cooling.
- Annealing alters the physical and sometimes chemical properties of a material to enhance its ductility and reduce its hardness, and increases its cold working properties.
- Improving metal's ductility can improve its ultimate tensile strength, which is its ability to deform under stress without cracking.

KNOT TYPE

Hinge Joint

- Vertical stay wire wraps around horizontal line wire to form a hinged joint. This joint enables the fence to give under pressure and spring back into shape. The hinge joint, along with special expansion crimps, allow the product to expand and contract with weather changes and to stretch and conform to land contours. The hinge joint can be found in the top, bottom, and filler wire of MAT's Farm Gard® field fence.

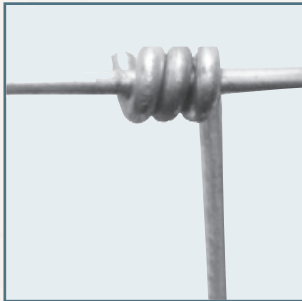

Hinge Knot

S-Knot

- Design uses a separate piece of wire to secure the line wire to the vertical stay wire. This type of knot prevents the fence from buckling or sagging. The S-Knot increases the vertical strength of the fence, while still allowing flexibility. It's design profile is smooth and unlikely to injure animal. S-Knot can be found in the filler wire of MAT's Horse Fence and Sheep & Goat Fence.

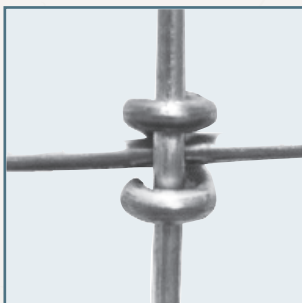

S-Knot

PRODUCT CODE

The code applies to our agricultural Field Fence and Horse Fence.

With every agricultural field or horse fence, the description (or style number) is a reference to the type of fence it classifies. The Pullout is the number of inches between the vertical stay wires.

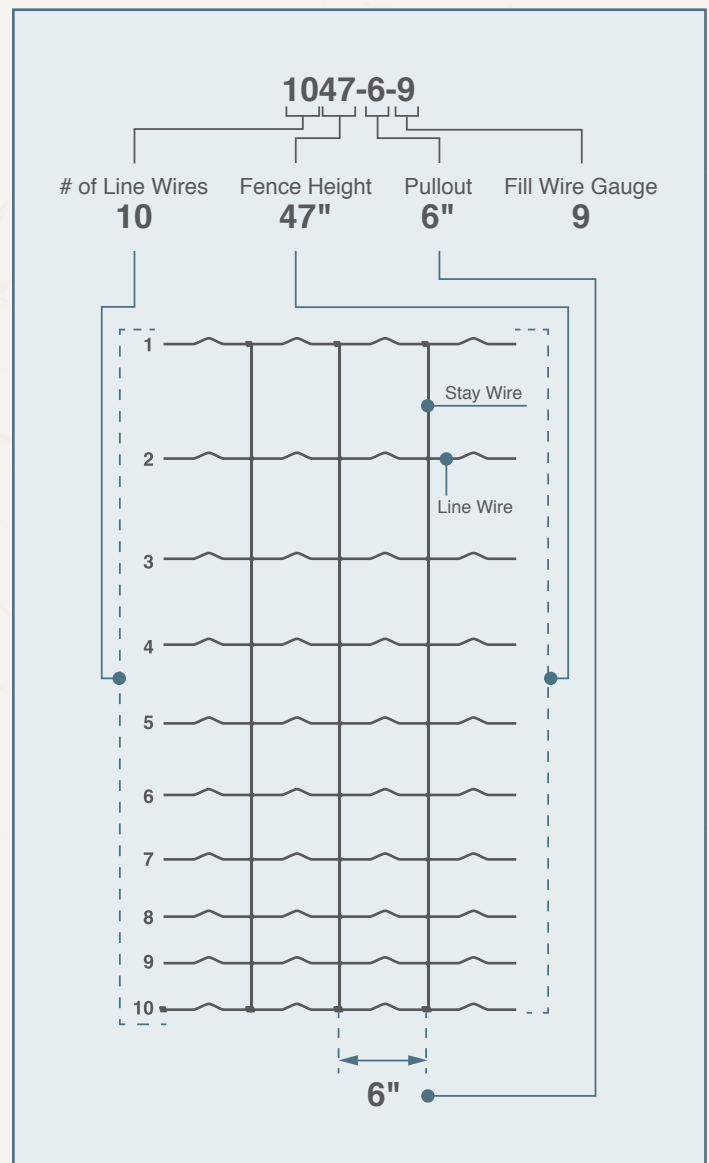



FENCING PRODUCTS

Yard Gard® and Farm Gard® brands of quality borders and fencing meet the needs of agricultural and residential property owners, industry and municipalities. Manufactured and distributed by Midwest Air Technologies, Inc., The Yard Gard® and Farm Gard® products can be found at home improvement centers, mass retailers, hardware and farm supply retailers, and wholesale distributors across North America. Yard Gard® and Farm Gard® are the brands that people trust.

For more information about our products, please call 1-800-628-8815





TABLE OF CONTENTS

AGRICULTURAL

HORSE FENCE	7
FIELD FENCE	8
HIGH TENSILE SMOOTH WIRE	9
SHEEP & GOAT FENCE	10
DEER & ORCHARD FENCE	11
ELECTRIC FIELD FENCE	12
BLACK ANNEALED WIRE	12
SMOOTH MERCHANT WIRE	13
REBAR TY WIRE	13
BARBED & BARBLESS WIRE	14
FENCE STAYS	14

FENCE POSTS & ACCESSORIES

T-POSTS	16
U-POSTS	17
ELECTRIC FENCE POSTS	18
T-POST BRACKETS	19
ACCESSORIES / EARTH ANCHORS	20

RESIDENTIAL WIRE FENCING

HARDWARE CLOTH	22
GALVANIZED WELDED WIRE	24
PVC WELDED WIRE	26
ECONOMY FENCE	26
GARDEN FENCE (RABBIT FENCE)	27
RABBIT NETTING	27
CAGE WIRE	27
POULTRY NETTING	28

MERCHANDISERS

IN- AISLE	30
PROP 65	31

AGRICULTURAL FENCING

If farms, fields and pastures could talk, they'd ask for Farm Gard® branded agricultural wire fencing product by name. Farm Gard® branded agricultural fencing and accessories don't just talk-the-talk, they walk-the-walk. When seeking the most effective solutions confining and protecting livestock and property, you can trust the Farm Gard® name. Products include: Farm Gard® Field Fence, Farm Gard® Horse Fence, Farm Gard® Electric Fence Wire, Sheep & Goat Fence, Deer & Orchard Fence, Galvanized Smooth Wire, Black Annealed Wire, Rebar Ty Wire, Fence Stays, and Farm Gard® Barbless & Barbed Wire.



**“FARM GARD® BRANDED AGRICULTURAL FENCING AND ACCESSORIES
DON'T JUST TALK-THE-TALK, THEY WALK-THE-WALK.”**

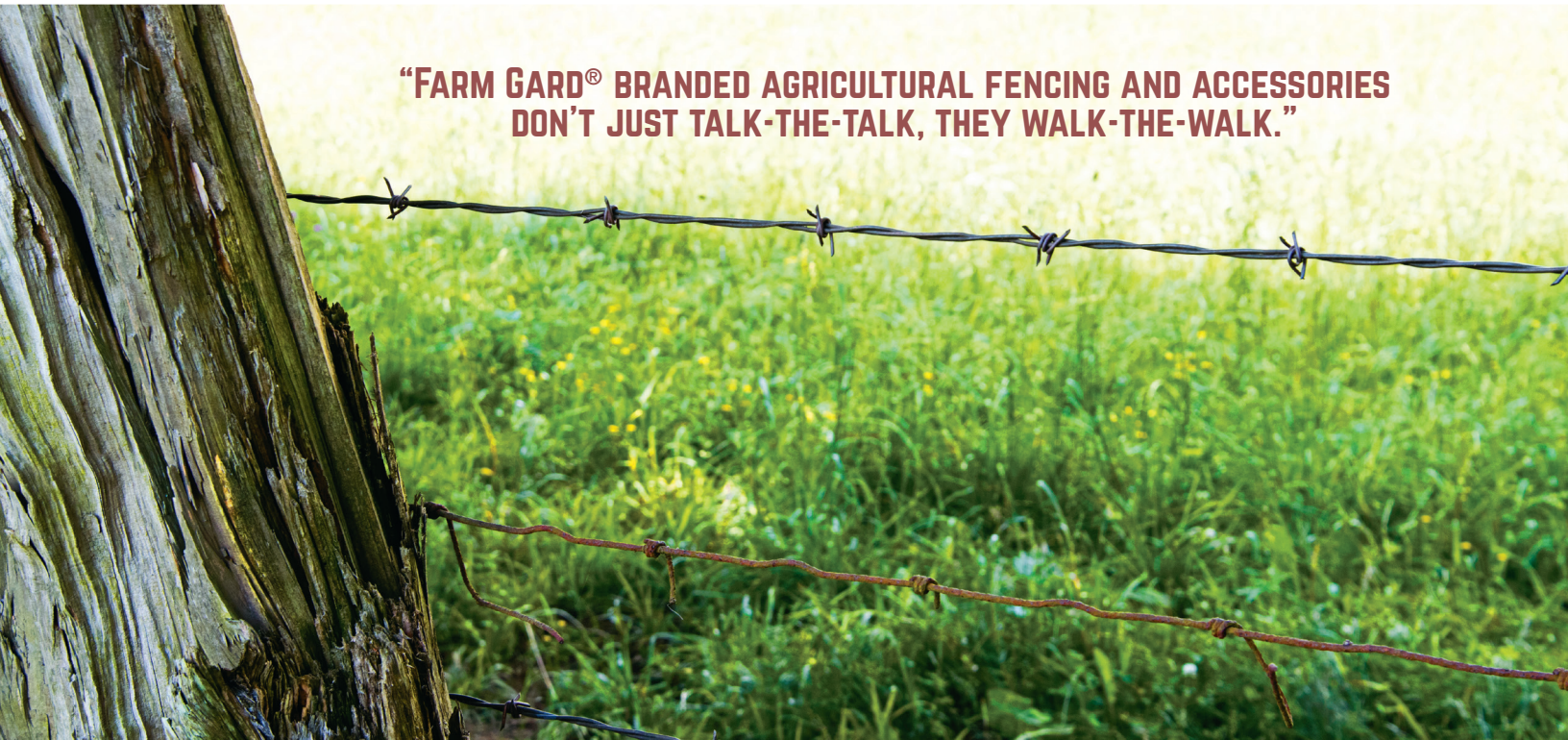

HORSE FENCE

Farm Gard® Horse Fence is designed to safely protect and confine horses and other hoofed animals.

- Time-tested, non-climbing 2x4 in. mesh flexes to minimize the potential for leg injuries.
- Roll Sizes: 100 ft. in 3 thru 6 ft. heights; 200 ft. rolls available in 4 ft. height only.
- Hinge Joint design and 10 gauge on top and bottom wires helps resist sagging.
- S-Knot design and 12.5 gauge fill wire maintains rigidity.
- Galvanized zinc coating (Class 1) for extended life.
- Built with pride in the U.S.

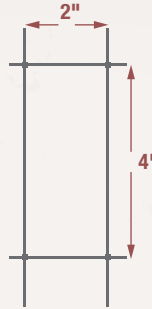

Meets or exceeds ASTM A116-05 standard for metallic-coated, steel-woven fence fabric

Meets or exceeds ASTM A641 / A 641M standard for zinc-coated galvanized carbon steel wire

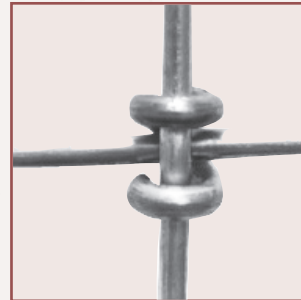

S-Knot

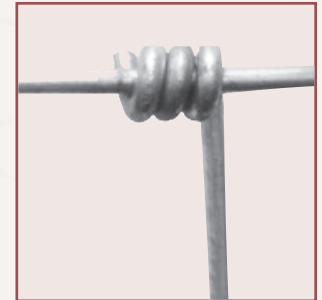

Hinge Joint

MAT Item Number	MAT Product Description	Classification	Roll Size	Each Wt (lbs.)	Class	UPC Code Number	*PROP 65
348306B	100', 12½ gauge	1036 - 2 - 12.5	36" x 100'	93	1	0 99713 03116 6	1
348308B	100', 12½ gauge	1348 - 2 - 12.5	48" x 100'	122	1	0 99713 03117 3	1
348310B	100', 12½ gauge	1660 - 2 - 12.5	60" x 100'	151	1	0 99713 03118 0	1
348312B	100', 12½ gauge	1972 - 2 - 12.5	72" x 100'	180	1	0 99713 03119 7	1
348328B	200', 12½ gauge	1348 - 2 - 12.5	48" x 200'	244	1	0 99713 02611 7	1



FIELD FENCE

Farm Gard® multi-purpose Field Fence is up to the challenge of corralling livestock such as cattle, hogs, sheep and ratites (large, flightless birds). Special expansion crimps enable this product to expand and contract with weather changes and to stretch to conform to land contours.

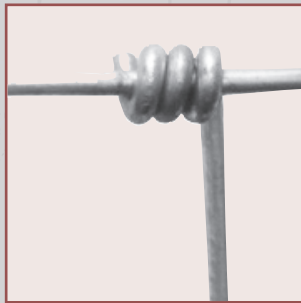
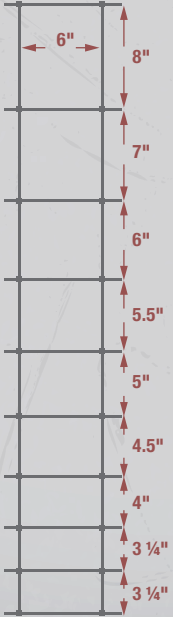

Hinge Joint



- Class 1 Galvanized zinc coating for extended life.
- Graduated height of vertical wire openings prevents animal hooves from stepping through.
- 12.5 or 11 gauge fill wire and 10 or 9 gauge top and bottom wires to minimize sagging.
- Hinged joint wire construction adds strength and flexibility.
- 3 wraps on top and bottom wires for maximum strength.
- Constructed in the USA.
- The hinge joint is the most common knot in agricultural fencing. The knot is formed by wrapping the vertical stay wire pieces around the line wire at each intersection. This design can also absorb animal impact without damage and is the most economical knot choice available.

Meets or exceeds ASTM A116-05 standard for metallic-coated, steel-woven fence fabric

Meets or exceeds ASTM A641 / A 641M standard for zinc-coated galvanized carbon steel wire

MAT Item Number	MAT Product Description	Classification	Roll Size	Each Wt (lbs.)	Class	UPC Code Number	*PROP 65
348124B	Field Fence, 11 Gauge	939 - 6 - 11	39" x 330'	241	1	0 9971303158 6	1
348126B	Field Fence, 11 Gauge	1047 - 6 - 11	47" x 330'	261	1	0 9971301909 6	1
348102B	Field Fence, 12.5 Gauge	832 - 6 - 12.5	32" x 330'	149	1	0 9971303111 1	1
348104B	Field Fence, 12.5 Gauge	939 - 6 - 12.5	39" x 330'	170	1	0 9971303112 8	1
348106B	Field Fence, 12.5 Gauge	1047 - 6 - 12.5	47" x 330'	191	1	0 9971303113 5	1
348105B	Field Fence, 12.5 Gauge	939 - 6 - 12.5	39" x 132'	70	1	0 9971305089 1	1
348108B	Field Fence, 12.5 Gauge	1047 - 6 -12.5	47" x 132'	79.5	1	0 9971305090 7	1
348134B	Field Fence, 12.5 Gauge	939 - 6 -12.5	39" x 330'	167.5	3	0 9971304454 8	1
348136B	Field Fence, 12.5 Gauge	1047 - 6 -12.5	47" x 330'	191	3	099713044555	1

HIGH TENSILE SMOOTH WIRE

- Superior strength grade vs. our standard smooth wire.
- Used most often in agricultural applications.
- Class 3 galvanized for extended life.

Meets or exceeds ASTM A 854 / A and 854 M-94 for high tensile smooth wire

MAT Item Number	MAT Product Description	Classification/ Size	Feet Per Coil	UOM*	Each Wt (lbs.)	Class	Master Pack Qty	Master Pack Wt (lbs.)	UPC Code Number	*PROP 65
317579A	12½ gauge	100# Coils	4000'	Coil	100.7	3	10	1007	0 99713 03051 0	1
317578A	12½ gauge	50# Coils	2000'	Coil	50.2	3	10	502	0 99713 03166 1	1

SHEEP & GOAT FENCE

Farm Gard® Sheep & Goat Fence is designed to safely protect and confine sheep, goats, and other hoofed animals.

- Time-tested, non-climbing 4"x4" mesh flexes to minimize the potential for leg injuries.
- S-Knot design and 12.5 gauge fill wire maintains rigidity.
- Class 1 Galvanized zinc coating for extended life.
- Hinge Joint design and 10 gauge on top and bottom wires helps resist sagging.
- Constructed in the USA.

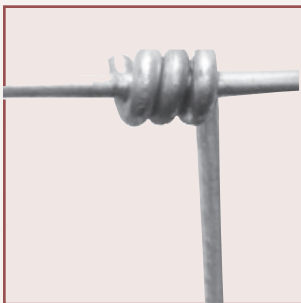
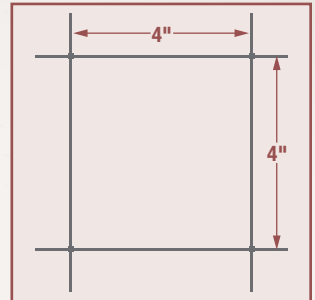

Hinge Joint

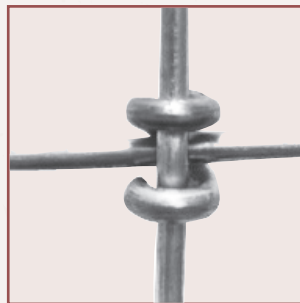

S-Knot



- The Hinge Joint is the most common knot in agricultural fencing, found on both low carbon and high tensile products. The knot is formed by wrapping the vertical stay wire pieces around the line wire at each intersection. This design can also absorb animal impact without damage and is the most economical knot choice available.
- The S-Knot design uses a separate piece of wire that attaches the line wire to the solid stay wire assuring maximum strength and prevents the fence from buckling or sagging. This design is smooth to the touch so you won't have to worry about injuries to your animals. The knot's strength holds up to even the strongest animal or weather impact while maintaining flexibility.

MAT Item Number	MAT Product Description	Classification	Roll Size	Each Wt (lbs.)	Class	UPC Code Number	*PROP 65
348404A	Sheep & Goat Fence, 12.5 gauge	1348 - 4 - 12.5	48" x 100'	80	1	0 99713 05320 5	1
348405A	Sheep & Goat Fence, 12.5 gauge	1348 - 4 - 12.5	48" x 330'	264	1	0 99713 05321 2	1

DEER & ORCHARD FENCE

Farm Gard® Deer & Orchard Fence is a specialty fixed-knot woven wire product designed to help protect the landscape from deer and other large game.

- Class 1 Galvanized metal fencing with 14.5 gauge wire offers strength.
- Hinged design provides flexible durability.
- Helps protect orchards, gardens and vineyards from deer and other large game.
- Can expand and contract to conform to land contours.
- The Hinge Joint is the most common knot in agricultural fencing, found on both low carbon and high tensile products. The knot is formed by wrapping the vertical stay wire pieces around the line wire at each intersection. This design can also absorb animal impact without damage and is the most economical knot choice available.

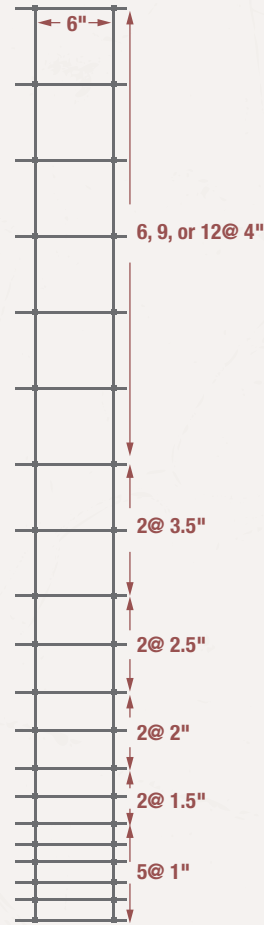

Hinge Joint

MAT Item Number	MAT Product Description	Classification	Roll Size	Each Wt (lbs.)	Class	UPC Code Number	*PROP 65
348401A	Deer & Orchard Fence, 14.5 gauge	1949 - 6 - 14.5	48" x 165'	85	1	0 09379 38461 2	4
348402A	Deer & Orchard Fence, 14.5 gauge	2160 - 6 - 14.5	60" x 165'	99	1	0 09379 70298 0	4
348403A	Deer & Orchard Fence, 14.5 gauge	2572 - 6 14.5	72" x 165'	114	1	0 09379 48963 8	4



ELECTRIC FIELD FENCE



Electric Field Fences work by converting an electrical source into a high voltage pulse. This pulse is release on to an insulated fence about once per second. The pulse can vary in duration, but typically lasts about 150 microseconds. When an animal makes contact with this fence, it completes the electronic circuit and receives a shock.

- Permanent or temporary.
- Ideal for rotating grazing.
- Galvanized for corrosion resistance.
- Less expensive than conventional fences.
- Easier to install than conventional fences.

MAT Item Number	MAT Product Description	Length	Feet per Coil	Gauge	Each Wt	Master Pack Wt	Master Pack Qty	UPC Code Number	*PROP 65
317774A	Electric Field Fence	¼ mile	1,320	14	225	45	2	0 9971300940 0	1
317772A	Electric Field Fence	½ mile	2,640	14	45	90	2	0 9971300939 4	1
317754A	Electric Field Fence	¼ mile	1,320	17	10.2	20.4	2	0 9971300914 4	1
317752A	Electric Field Fence	½ mile	2,640	17	20.5	41	2	0 9971300937 7	1

BLACK ANNEALED WIRE



Annealing is a process used to return to the wire its ductility, which it had lost during drawing. In agriculture annealed wire is used for baling hay or for fencing projects.

- Ideal for rotating grazing.
- Permanent or temporary.
- Galvanized for corrosion resistance.

MAT Item Number	MAT Product Description	Size	Feet per Coil	Gauge	Master Pack Qty	UPC Code Number	*PROP 65
317627A	Black Annealed Wire	10 lb. coil	170	9	10	0 9971301722 1	1
317624A	Black Annealed Wire	10 lb. coil	392	12.5	10	0 9971301723 8	1
317677A	Black Annealed Wire	100 lb. coil	1,705	9	1	0 9971301724 5	1
317676A	Black Annealed Wire	100 lb. coil	2,057	10	1	0 9971301725 2	1
317675A	Black Annealed Wire	100 lb. coil	3,924	11	1	0 9971301727 6	1
317673A	Black Annealed Wire	100 lb. coil	5,858	14	1	0 9971301728 3	1
317672A	Black Annealed Wire	100 lb. coil	9,598	16	1	0 9971301729 0	1

SMOOTH MERCHANT WIRE

Ideal for all-purpose tying around the farm and the home.

- Multi-use, single strand wire.
- Ideal for tying, fastening, hanging, and bundling.
- Used for shed, shop, home, and farm applications.
- Class 3 Galvanized for high resistance to corrosion and rust.

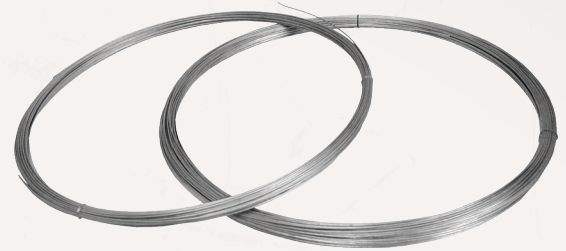

MAT Item Number	MAT Product Description	Size	Feet per Coil	Gauge	Master Pack Qty	UPC Code Number	*PROP 65
317527A	Smooth Merchant Wire	10 lb. coil	170	9	10	0 9971300943 1	1
317526A	Smooth Merchant Wire	10 lb. coil	205	10	10	0 9971301703 0	1
317525A	Smooth Merchant Wire	10 lb. coil	258	11	10	0 9971301704 7	1
317524A	Smooth Merchant Wire	10 lb. coil	392	12.5	10	0 9971300942 4	1
317523A	Smooth Merchant Wire	10 lb. coil	585	14	10	0 9971301705 4	1
317522A	Smooth Merchant Wire	10 lb. coil	960	16	10	0 9971301706 1	1
317577A	Smooth Merchant Wire	100 lb. coil	1,705	9	10	0 9971301707 8	1
317576A	Smooth Merchant Wire	100 lb. coil	2,057	10	10	0 9971301708 5	1
317575A	Smooth Merchant Wire	100 lb. coil	2,582	11	10	0 9971301709 2	1
317574A	Smooth Merchant Wire	100 lb. coil	3,924	12.5	10	0 9971301710 8	1
317573A	Smooth Merchant Wire	100 lb. coil	5,858	14	10	0 9971301711 5	1
317572A	Smooth Merchant Wire	100 lb. coil	9,598	16	10	0 9971301712 2	1

REBAR TY WIRE

- Made from softer, more flexible annealed wire
- Easy to twist
- For use with rebar in concrete applications
- 3.5 lb. coils packaged ten per carton



MAT Item Number	MAT Product Description	Size	UOM	Each Wt	Master Pack Wt	Master Pack Qty	UPC Code Number	*PROP 65
901130A	Rebar Ty Wire	3.5# Coils	Roll	3.6	36	10	0 9971300938 7	2

BARBED & BARBLESS WIRE

Barbed Wire

- Designed for easy unrolling.
- Sharp 2 or 4 point barb options spaced every 5 inches.
- Heavy-duty metal carrier for safe, convenient transport.
- Use fence stays to keep barbed wire neat and evenly spaced.
- Use with chain link or other fencing barriers for added security

Meets or exceeds ASTM A121-92 and A121-99 (2004) standard specification for metallic-coated, carbon steel barbed wire

Meets or exceeds ASTM A641-A641 M standard specification for zinc-coated galvanized carbon steel wire

Barbless Wire

- Ideal for horses or locations where barbed wire is banned.
- Made from Class 1 Galvanized, 12.5 gauge, double strand smooth wire that can be electrified.



MAT Item Number	MAT Product Description	Type	Feet per Coil	Gauge	Each Wt	Master Pack Qty	UPC Code Number	*PROP 65
317821A	Barbed Wire	2pt, 5" spacing, Class 1	1,320	12.5	73.3	27	0 9971301713 9	1
317831A	Barbed Wire	4pt, 5" spacing, Class 1	1,320	12.5	83.8	27	0 9971301714 6	1
317801A	Barbless Wire	Barbless, Class 1	1,320	12.5	66.2	36	0 9971301716 0	1
317871A	Barbed Wire	2pt, 5" spacing, Class 3	1,320	15.5	42	48	0 9971301778 8	2
317881A	Barbed Wire	4pt, 5" spacing, Class 3	1,320	15.5	43.5	48	0 9971301715 3	4

FENCE STAYS

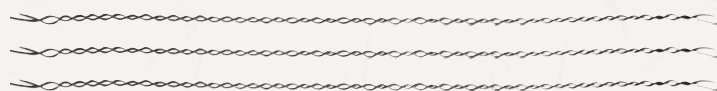

Designed to keep barbed wire fence evenly spaced.

- Class 1 Galvanized for corrosion resistance.
- Reduces the quantity needed and expense of fence posts.
- 100 fence stays per pack.

MAT Item Number	MAT Product Description	Length	Gauge	Each Wt	Master Pack Qty	UPC Code Number	*PROP 65
901083A	Fence Stay	36"	9.5	.33	100	0 9971391083 6	1
901084A	Fence Stay	42"	9.5	.39	100	0 9971391084 3	1
901085A	Fence Stay	48"	9.5	.46	100	0 9971391085 0	1



FENCE POSTS & ACCESSORIES

In addition to our large assortment of agricultural wire fencing, Midwest Air Technologies, Inc. manufactures a compatible line of posts to finish your job. With years of proven know-how, nobody understands your accessory needs better than Farm Gard®. Nobody!

Products include: T-Posts, U-Posts, Earth Anchors, Fence Post Drivers and Fence Post Clips.



“WITH YEARS OF PROVEN KNOW-HOW, NOBODY UNDERSTANDS YOUR FENCE POST NEEDS BETTER THAN FARM GARD®.”

T-POST

Our T-Posts rate among the highest quality sold in the US and provide excellent performance and service for residential, farm, industrial, and commercial applications.

- 2 coats of protective enamel with exclusive prime coat finish for maximum rust protection.
- Beige top signifies Farm Gard® quality and provides better visibility at night.
- Studded design adds strength, secures fence fabric, and prevents slippage of T-Post clips and insulators.
- Rugged, tight welded anchor plate minimizes sideways and rotational movement.
- Out T-Posts exceed ASTM A702A on tensile strength, ASTM A702 on hardness, and ASTM A702 on elongation.

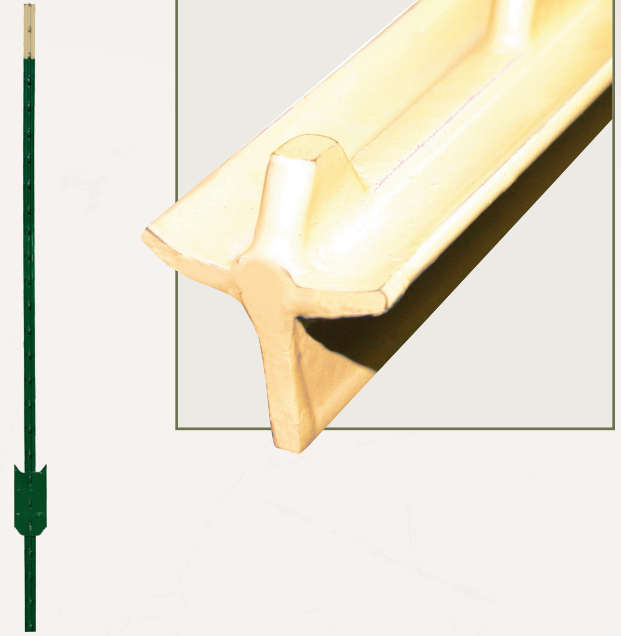

Beige color application is registered in the U.S. Patent and Trademark Office

MAT Item Number	MAT Product Description	Length	Weight	Master Pack Qty	Master Pack Wt (Lbs)	UPC Code Number	*PROP 65
901174AB	Medium Weight; 1.25 lbs/ft	5'	6.4 lbs.	200	1,280	0 9971391174 1	2
901175AB	Medium Weight; 1.25 lbs/ft	5.5'	6.9 lbs.	200	1,380	0 9971391175 8	2
901176AB	Medium Weight; 1.25 lbs/ft	6'	7.5 lbs.	200	1,500	0 9971391176 5	2
901178AB	Medium Weight; 1.25 lbs/ft	6.5'	8.5 lbs.	200	1,700	0 9971391178 9	2
901177AB	Medium Weight; 1.25 lbs/ft	7'	8.7 lbs.	200	1,740	0 9971391177 2	2
901181AB	Medium Weight; 1.25 lbs/ft	7.5'	9.5 lbs.	200	1,900	0 9971303163 0	2
901180AB	Medium Weight; 1.25 lbs/ft	8'	10.1 lbs.	200	2,020	0 9971391180 2	2
901172A	Heavy Weight; 1.33 lbs/ft	10.2'	14.1 lbs.	200	2,820	0 9971391172 7	2



U-POST

- Powder coated steel finish.
- Can be used to post warning signs.
- For garden, light farm and residential use.
- Notched design for securing fence to post.
- Suggested spacing of 5 to 10 ft. depending on fence type.
- Designed with a riveted or welded anchor plate to minimize sideways and rotational movement.
- U-channel construction provides maximum strength along with riveted anchor plate.

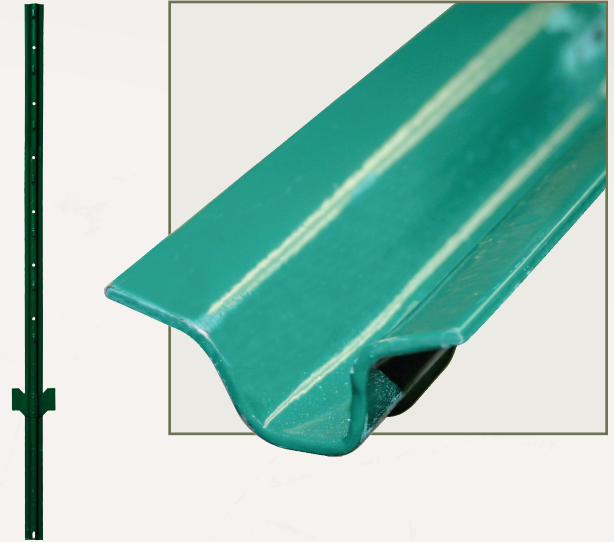

MAT Item Number	MAT Product Description	Length	Weight	Master Pack Qty	Master Pack Wt (Lbs)	UPC Code Number	*PROP 65
901153A	Lite Duty, 14 gauge	3'	1.5	150	225	0 9971391153 6	2
901154A	Lite Duty, 14 gauge	4'	1.9	150	285	0 9971391154 3	2
901155A	Lite Duty, 14 gauge	5'	2.3	150	345	0 9971391155 0	2
901150A	Lite Duty, 14 gauge	6'	2.7	150	405	0 9971391150 5	2
901158A	Heavy Duty, 13 gauge	5'	4.7	150	705	0 9971391158 1	2
901156A	Heavy Duty, 13 gauge	6'	5.5	150	825	0 9971391156 7	2
901157A	Heavy Duty, 13 gauge	7'	6.4	150	960	0 9971391157 4	2



ELECTRIC FENCE POSTS

Step-In Posts, Plastic

- Constructed with molded clips for use with electrical fences.
- Features a ledge for you to step down for easy installation.
- Polypropylene-reinforced steel construction.

Step-In Post, Galvanized Steel

Our Galvanized Steel Electric Fence Post is a light, round steel post that's designed to hold electric fence wire when accompanied by a common wire insulator.

- Holds electric fence wire when used with a common wire insulator.
- This galvanized-steel electric fence post stands 4 ft. tall and features a post spade to provide stability and minimize rotation.

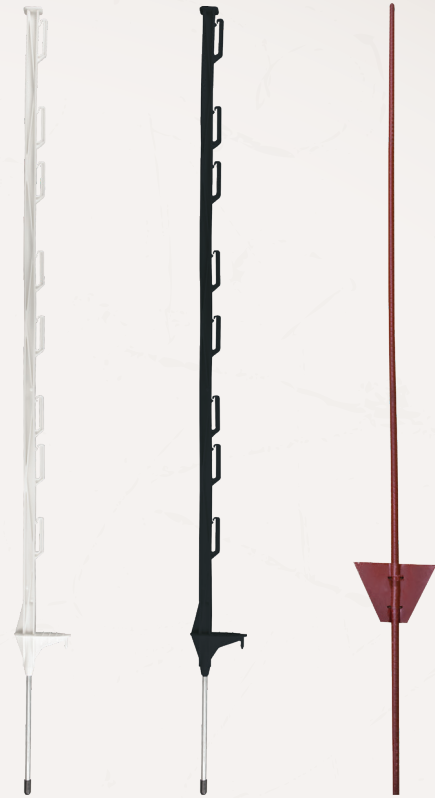

MAT Item Number	MAT Product Description	Weight	Length	Master Pack Qty	Master Pack Wt (Lbs)	UPC Code Number	*PROP 65
901120A	Step-In Post White	.81	48"	50	40.5	0 9971305309 0	2
901121A	Step-In Post Black	.81	48"	50	40.5	0 9971305310 6	2
901183A	Electric Fence Post 3/8"	1.5	48"	25	37.5	0 9971391183 3	2



T-POST BRACKETS

Our T-Posts Brackets provide a convenient way of increasing the utility of your existing T-Posts. Select 2" brackets for lighter applications, and 3" brackets for more robust installations.

Easy to install, these brackets slide over the top of a T-Post and lock onto the T-Post notches. Once in place, these brackets provide stable support. Tilt the brackets up to quickly adjust to the desired height.

Brackets are available in vertical and horizontal orientations, allowing for a myriad of uses.

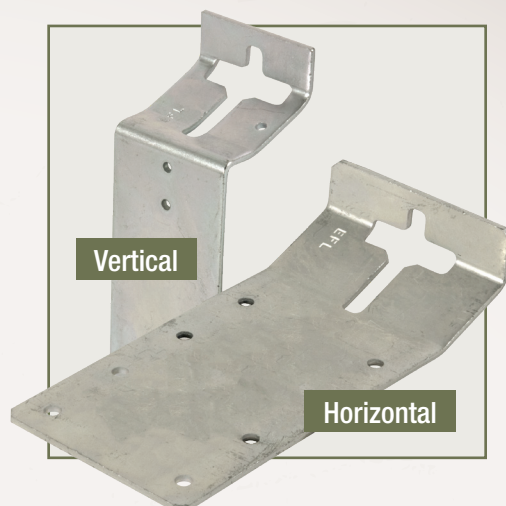

MAT Item Number	MAT Product Description	Weight	Master Pack Qty	Master Pack Wt (Lbs)	UPC Code Number	*PROP 65
901191EFL	2" Horizontal T-Post Bracket	.38 lbs.	12	4.5	0 9971305373 1	2
901192EFL	2" Vertical T-Post Bracket	.38 lbs.	12	4.5	0 9971305374 8	2
901193EFL	3" Horizontal T-Post Bracket	.58 lbs.	12	6.9	0 9971305375 5	2
90119EFL	3" Vertical T-Post Bracket	.58 lbs.	12	6.9	0 9971305376 2	2



ACCESSORIES

Fence Post Driver

- Designed to minimize damage to fence post tops.
- Eases work of driving t-posts into the ground.
- Handles are tapered for comfortable hand placement.
- 23.5" length with weighted, reinforced steel head.
- 2-7/8" Inside driver diameter.



MAT Item Number	MAT Product Description	Size	Weight	Master Pack Qty	Master Pack Wt (Lbs)	UPC Code Number	*PROP 65
901147A	Fence Post Driver	23.5"	14 lbs.	2	28	0 9971303200 2	3

Fence Post Clips (for T-Posts)

- 25 clips per bag.
- Easy installation.
- Holds strong through tough weather conditions.



MAT Item Number	MAT Product Description	Size	Weight	Master Pack Qty	Master Pack Wt (Lbs)	UPC Code Number	*PROP 65
901169B	Fence Post Clips (For T-Posts)		25/bag	40		0 9971303200 2	2

Earth Anchors

- Use to secure, tie down, or rope-off area.
- Welded base screw self digs into all types of soil.
- Easy installation – twist auger into ground and tie off to eyelet.



MAT Item Number	MAT Product Description	Size	Weight	Master Pack Qty	Master Pack Wt (Lbs)	UPC Code Number	*PROP 65
901111A	Earth Anchor	3" x 15"	1.6	10	160	0 9971391111 6	5
901113A	Earth Anchor	3" x 30"	2.7	10	27	0 9971391113 0	5
901114A	Earth Anchor	4" x 40"	3.3	10	33	0 9971391114 7	5
901018A	Earth Anchor	6" x 48"	8.7	10	87	0 9971391018 8	5





RESIDENTIAL FENCING PRODUCTS

Along with our agricultural fencing applications, Yard Gard® has a history of innovative residential fencing solutions. Yard Gard® has been anticipating the needs of the residential fencing marketplace for longer than anyone. Products include: Hardware Cloth, Welded Wire, Garden Fence, Economy Fence, Poultry Netting and Rabbit Netting under the registered name Yard Gard®



"YARD GARD® HAS ANTICIPATED THE NEEDS OF THE RESIDENTIAL FENCING MARKETPLACE LONGER THAN ANYONE."



HARDWARE CLOTH

- Ideal for screen doors, gutter guards, animal control, cages, tree guards, gardening applications, craft projects and more
- Choose PVC color option for a more environmentally pleasing appearance and additional weather protection
- Double zinc coated for maximum rust resistance
- Available in three gauges: 19, 23 and 27
- Lightweight, flexible and economical

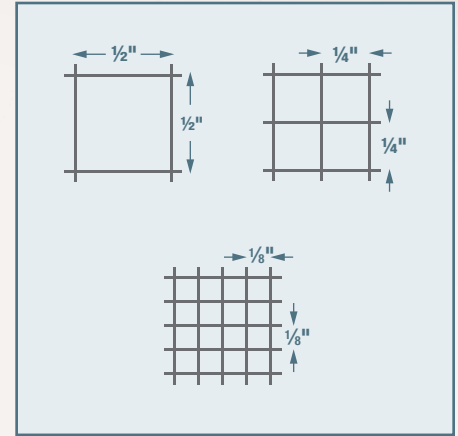

MAT Item Number	MAT Product Description	UOM	Size	Weight	Master Pack Qty	Master Pack Wt	Pallet Qty	UPC Code Number	*PROP 65
308180B	Galvanized, 27 gauge, 1/8" Mesh	Roll	24" x 5'	1.4	12	16.3	360	0 99713 05304 5	1
308182B	Galvanized, 27 gauge, 1/8" Mesh	Roll	24" x 100'	25.3	1	25.3	36	0 99713 03265 1	1
308183B	Galvanized, 27 gauge, 1/8" Mesh	Roll	36" x 100'	37.9	1	37.9	36	0 99713 03266 8	1
308231B	Galvanized, 23 gauge, 1/4" Mesh	Roll	24" x 5'	1.3	12	15.3	432	0 99713 03182 1	1
308232B	Galvanized, 23 gauge, 1/4" Mesh	Roll	36" x 5'	2.0	12	23.8	288	0 99713 03183 8	1
308234B	Galvanized, 23 gauge, 1/4" Mesh	Roll	4 8" x 5'	2.6	12	31.7	240	0 99713 03185 2	1
308235B	Galvanized, 23 gauge, 1/4" Mesh	Roll	24" x 10'	2.6	12	31.7	360	0 99713 03186 9	1
308237B	Galvanized, 23 gauge, 1/4" Mesh	Roll	36" x 10'	6.0	12	48.7	240	0 99713 03188 3	1
308240B	Galvanized, 23 gauge, 1/4" Mesh	Roll	48" x 10'	5.3	12	63.5	180	0 99713 03191 3	1
308212B	Galvanized, 23 gauge, 1/4" Mesh	Roll	24" x 25'	6.5	4	25.5	120	0 99713 03171 5	1
308233B	Galvanized, 23 gauge, 1/4" Mesh	Roll	36" x 25'	10.4	4	41.8	100	0 99713 03184 5	1
308236B	Galvanized, 23 gauge, 1/4" Mesh	Roll	48" x 25'	13.9	4	55.8	48	0 99713 03187 6	1
308247B	Galvanized, 23 gauge, 1/4" Mesh	Roll	24" x 50'	13.9	1	13.9	42	0 99713 03192 0	1
308238B	Galvanized, 23 gauge, 1/4" Mesh	Roll	36" x 50'	20.9	1	20.9	42	0 99713 03189 0	1
308239B	Galvanized, 23 gauge, 1/4" Mesh	Roll	48" x 50'	27.9	1	27.9	42	0 99713 03190 6	1
308245B	Galvanized, 23 gauge, 1/4" Mesh	Roll	24" x 100'	27.9	1	27.9	20	0 99713 03271 2	1
308249B	Galvanized, 23 gauge, 1/4" Mesh	Roll	30" x 100'	34.9	1	34.9	20	0 99713 03275 0	1
308241B	Galvanized, 23 gauge, 1/4" Mesh	Roll	36" x 100'	42.0	1	42.0	20	0 99713 03267 5	1
308242B	Galvanized, 23 gauge, 1/4" Mesh	Roll	48" x 100'	55.8	1	55.8	20	0 99713 03268 2	1
308221B	Galvanized, 19 gauge, 1/2" Mesh	Roll	24" x 5'	1.7	12	20.9	360	0 99713 03172 2	1
308222B	Galvanized, 19 gauge, 1/2" Mesh	Roll	36" x 5'	2.6	12	31.5	240	0 99713 03173 9	1
308223B	Galvanized, 19 gauge, 1/2" Mesh	Roll	48" x 5'	3.7	12	44.2	192	0 99713 03174 6	1
308224B	Galvanized, 19 gauge, 1/2" Mesh	Roll	24" x 25'	8.7	4	34.6	96	0 99713 03175 3	1
308225B	Galvanized, 19 gauge, 1/2" Mesh	Roll	36" x 25'	12.6	4	50.3	64	0 99713 03176 0	1
308226B	Galvanized, 19 gauge, 1/2" Mesh	Roll	48" x 25'	17.0	4	67.9	48	0 99713 03177 7	1
308227B	Galvanized, 19 gauge, 1/2" Mesh	Roll	24" x 10'	3.6	12	42.8	288	0 99713 03178 4	1

MAT Item Number	MAT Product Description	UOM	Size	Weight	Master Pack Qty	Master Pack Wt	Pallet Qty	UPC Code Number	*PROP 65
308228B	Galvanized, 19 gauge, 1/2" Mesh	Roll	36" x 10'	5.5	12	66.1	192	0 99713 03179 1	1
308230B	Galvanized, 19 gauge, 1/2" Mesh	Roll	48" x 10'	7.3	12	88.1	144	0 99713 03181 4	1
308199B	Galvanized, 19 gauge, 1/2" Mesh	Roll	24" x 50'	17.6	1	17.6	30	0 99713 03169 2	1
308200B	Galvanized, 19 gauge, 1/2" Mesh	Roll	36" x 50'	27.6	1	27.6	30	0 99713 03170 8	1
308229B	Galvanized, 19 gauge, 1/2" Mesh	Roll	48" x 50'	40.9	1	40.9	30	0 99713 38229 9	1
308246B	Galvanized, 19 gauge, 1/2" Mesh	Roll	24" x 100'	36.8	1	36.8	16	0 99713 03272 9	1
308248B	Galvanized, 19 gauge, 1/2" Mesh	Roll	30" x 100'	45.8	1	45.8	16	0 99713 03274 3	1
308243B	Galvanized, 19 gauge, 1/2" Mesh	Roll	36" x 100'	55.1	1	55.1	16	0 99713 03269 9	1
308244B	Galvanized, 19 gauge, 1/2" Mesh	Roll	48" x 100'	73.4	1	73.4	16	0 99713 03270 5	1
308253B	PVC Ctd - Green, 19 gauge, 1/2" Mesh	Roll	24" x 5'	2.2	12	25.9	288	0 99713 03193 7	1
308254B	PVC Ctd - Green, 19 gauge, 1/2" Mesh	Roll	36" x 5'	3.4	12	41.3	192	0 99713 03194 4	1
308258B	PVC Ctd - Green, 19 gauge, 1/2" Mesh	Roll	24" x 25'	11.5	1	11.5	42	0 99713 38258 9	1
308259B	PVC Ctd - Green, 19 gauge, 1/2" Mesh	Roll	36" x 25'	17.2	1	17.2	42	0 99713 03277 4	1
308260B	PVC Ctd - Green, 19 gauge, 1/2" Mesh	Roll	48" x 25'	22.9	1	22.9	42	0 99713 03273 6	1
308262B	PVC Ctd - Green, 19 gauge, 1/2" Mesh	Roll	24" x 50'	22	2	44	40	0 99713 05305 2	1



308180B is excellent for an apiary.

GALVANIZED WELDED WIRE

- Ideal for property delineation, confinement of non-aggressive animals, drain guards, fencing for backing split fence rail and more
- Available in 25', 50' and 100' rolls and 12.5, 14, and 16 gauges
- Ideal for inexpensive temporary confinement applications
- A general purpose fence providing strength and stability
- 2', 3', 4', 5', and 6' heights and variety of mesh sizes
- Class 1 galvanized zinc coating for long-life

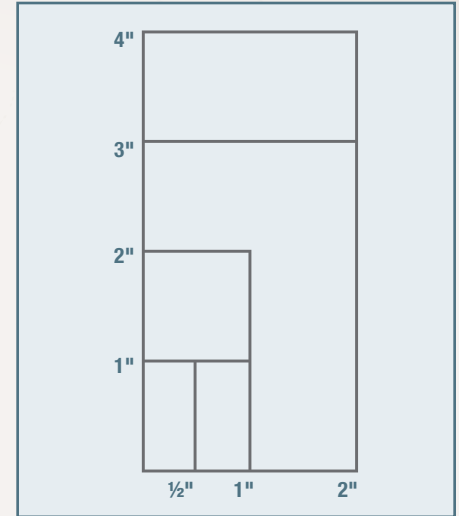

MAT Item Number	MAT Product Description	UOM	Size	Weight	Master Pack Qty	Master Pack Wt	Pallet Qty	UPC Code Number	*PROP 65
309301A	Galvanized, 16 gauge, .5" x 1" Mesh	Roll	24" x 25'	17.1	1	17.1	42	0 99713 39301 1	2
309303A	Galvanized, 16 gauge, .5" x 1" Mesh	Roll	24" x 100'	68.4	1	68.4	9	0 99713 39303 5	2
309306A	Galvanized, 16 gauge, .5" x 1" Mesh	Roll	36" x 100'	102.3	1	102.3	9	0 99713 39306 6	2
309304A	Galvanized, 16 gauge, .5" x 1" Mesh	Roll	48" X 100'	136.2	1	136.2	9	0 99713 39304 2	2
309312A	Galvanized, 16 gauge, 1" x 1" Mesh	Roll	24" x 25'	13.2	1	13.2	42	0 99713 39312 7	2
309313A	Galvanized, 16 gauge, 1" x 1" Mesh	Roll	24" x 100'	50.6	1	50.6	9	0 99713 39313 4	2
309314A	Galvanized, 16 gauge, 1" x 1" Mesh	Roll	36" x 100'	74.9	1	74.9	9	0 99713 39314 1	2
309315A	Galvanized, 16 gauge, 1" x 1" Mesh	Roll	48" X 100'	102.5	1	102.5	9	0 99713 39315 8	2
309320A	Galvanized, 16 gauge, 1" x 2" Mesh	Roll	24" x 25'	9.3	1	9.3	42	0 99713 39320 2	2
309213A	Galvanized, 14 gauge, 1" x 1" Mesh	Roll	36" x 100'	105.0	1	105.0	9	0 99713 39213 7	2
309214A	Galvanized, 14 gauge, 1" x 1" Mesh	Roll	48" x 100'	139.5	1	139.5	9	0 99713 39214 4	2
309221A	Galvanized, 14 gauge, 1" x 2" Mesh	Roll	24" x 25'	15.2	1	15.2	30	0 99713 39221 2	2
309222A	Galvanized, 14 gauge, 1" x 2" Mesh	Roll	24" x 100'	55.1	1	55.1	9	0 99713 39222 9	2
309223A	Galvanized, 14 gauge, 1" x 2" Mesh	Roll	36" x 100'	82.3	1	82.3	9	0 99713 39223 6	2
309224A	Galvanized, 14 gauge, 1" x 2" Mesh	Roll	48" X 100'	109.6	1	109.6	9	0 99713 39224 3	2
309226A	Galvanized, 14 gauge, 1" x 2" Mesh	Roll	60" x 100'	137.0	1	137.0	9	0 99713 39226 7	2
309225A	Galvanized, 14 gauge, 1" x 2" Mesh	Roll	72" X 100'	164.2	1	164.2	9	0 99713 39225 0	2
308301B	Galvanized, 14 gauge, 2" x 4" Mesh	Roll	36" x 50'	20.5	1	20.5	20	0 99713 03126 5	2
308302B	Galvanized, 14 gauge, 2" x 4" Mesh	Roll	48" x 50'	27.3	1	27.3	20	0 99713 03127 2	2
308303B	Galvanized, 14 gauge, 2" x 4" Mesh	Roll	60" x 50'	33.9	1	33.9	20	0 99713 03128 9	2
308304B	Galvanized, 14 gauge, 2" x 4" Mesh	Roll	72" X 50'	40.9	1	40.9	20	0 99713 03129 6	2
308311B	Galvanized, 14 gauge, 2" x 4" Mesh	Roll	36" x 100'	41.1	1	41.1	9	0 99713 03130 2	2

MAT Item Number	MAT Product Description	UOM	Size	Weight	Master Pack Qty	Master Pack Wt	Pallet Qty	UPC Code Number	*PROP 65
308312B	Galvanized, 14 gauge, 2" x 4" Mesh	Roll	48" X 100'	54.5	1	54.5	9	0 99713 03131 9	2
308313B	Galvanized, 14 gauge, 2" x 4" Mesh	Roll	60" x 100'	67.9	1	67.9	9	0 99713 03132 6	2
308314B	Galvanized, 14 gauge, 2" x 4" Mesh	Roll	72" X 100'	80.2	1	80.2	9	0 99713 03133 3	2
308331A	Galvanized, 14 gauge, 2" x 4" Mesh	Roll	36" x 50'	36.3	1	36.3	16	0 99713 38331 9	2
308332A	Galvanized, 14 gauge, 2" x 4" Mesh	Roll	48" x 50'	48.4	1	48.4	16	0 99713 38332 6	2
308333A	Galvanized, 14 gauge, 2" x 4" Mesh	Roll	60" x 50'	60.6	1	60.6	16	0 99713 38333 3	2
308334A	Galvanized, 14 gauge, 2" x 4" Mesh	Roll	72" X 50'	72.7	1	72.7	16	0 99713 38334 0	2
308321A	Galvanized, 14 gauge, 2" x 4" Mesh	Roll	36" x 100'	70.3	1	70.3	9	0 99713 38321 0	2
308322A	Galvanized, 14 gauge, 2" x 4" Mesh	Roll	48" X 100'	92.3	1	92.3	9	0 99713 38322 7	2
308323A	Galvanized, 14 gauge, 2" x 4" Mesh	Roll	60" x 100'	114.7	1	114.7	9	0 99713 38323 4	2
308324A	Galvanized, 14 gauge, 2" x 4" Mesh	Roll	72" X 100'	138.0	1	138.0	9	0 99713 38324 1	2



PVC WELDED WIRE

- Virtually maintenance free
- Available in 2" x 4" and 2" x 3" mesh
- Adds a rich look by complimenting natural surroundings
- All the benefits of welded wire but coated to enhance longevity and appearance
- Uniformly galvanized prior to coating for reinforced rust and wear protection
- A versatile, lighter weight and economical solution to ornamental fencing

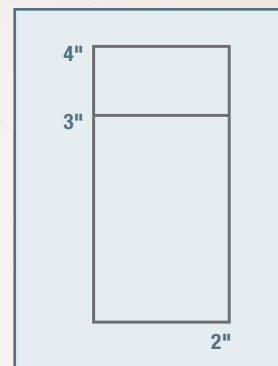

MAT Item Number	MAT Product Description	UOM	Size	Weight	Master Pack Qty	Master Pack Wt	Pallet Qty	UPC Code Number	*PROP 65
308357A	Green, 14 gauge, 2" x 4" Mesh	Roll	36" x 50'	16.9	1	16.9	20	0 99713 38357 9	2
308358A	Green, 14 gauge, 2" x 4" Mesh	Roll	48" x 50'	22.5	1	22.5	20	0 99713 38358 6	2
308350B	Green, 16 gauge, 2" x 3" Mesh	Roll	24" x 25'	5.9	1	5.9	42	0 99713 03134 0	2
308349A	Green, 16 gauge, 2" x 3" Mesh	Roll	24" x 50'	13.2	1	13.2	36	0 99713 38349 4	2
308351B	Green, 16 gauge, 2" x 3" Mesh	Roll	36" x 50'	16.7	1	16.7	36	0 99713 03135 7	2
308352B	Green, 16 gauge, 2" x 3" Mesh	Roll	48" x 50'	22.4	1	22.4	36	0 99713 03136 4	2
308354B	Green, 16 gauge, 2" x 3" Mesh	Roll	60" x 50'	28.0	1	28.0	20	0 99713 03137 1	2
308381B	Black, 16 gauge, 2" x 3" Mesh	Roll	36" x 50'	16.7	1	16.7	20	0 99713 03164 7	2
308382B	Black, 16 gauge, 2" x 3" Mesh	Roll	48" x 50'	22.4	1	22.4	20	0 99713 03165 4	2

ECONOMY FENCE (WELDED WIRE)

- 16 gauge , 2" x 3" mesh
- Ideal backing for post and rail fencing
- An economical option for home and garden applications
- Also Ideal for fencing vegetable and flower gardens, making compost bins, and protecting seedlings

MAT Item Number	MAT Product Description	UOM	Size	Weight	Master Pack Qty	Master Pack Wt	Pallet Qty	UPC Code Number	*PROP 65
308361B	16 gauge, 2" x 3" Mesh	Roll	36" x 50'	15.1	1	15.1	36	0 99713 03141 8	2
308362B	16 gauge, 2" x 3" Mesh	Roll	48" x 50'	20.0	1	20.0	36	0 99713 03142 5	2
308360B	16 gauge, 2" x 3" Mesh	Roll1	24" x 50'	10.4	1	10.4	30	0 99713 05303 8	2

GARDEN FENCE (RABBIT FENCE)

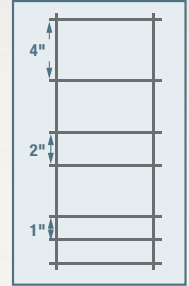

- Vinyl coated option blends more naturally into surroundings
- Upper horizontal wire spacing allows hands to pass through
- Specifically designed to keep out rabbits and other nuisance varmints
- This lightweight galvanized wire is an excellent temporary barrier around trees, bushes and flowers
- Horizontal wire spacing gets progressively closer near the ground where protection is needed most (4-2-1 in.)

MAT Item Number	MAT Product Description	UOM	Size	Weight	Master Pack Qty	Master Pack Wt	Pallet Qty	UPC Code Number	*PROP 65
308374A	Galvanized, 14 gauge	Roll	28" x 25'	6.6	1	6.6	72	0 99713 38374 6	2
308371B	Galvanized, 14 gauge	Roll	28" x 50'	12.7	1	12.7	42	0 99713 03138 8	2
308372A	Galvanized, 14 gauge	Roll	40" x 50'	16.1	1	16.1	42	0 99713 38372 2	2
308376B	Green, 16 gauge	Roll	28" x 50'	14.3	1	14.3	25	0 99713 03139 5	2

RABBIT NETTING

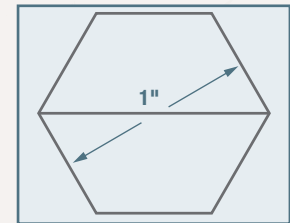

Hexagonal Recommended by Forestry Commission

- Effective protection against grazing rabbits
- Can also be used for rabbit hutches or chicken runs
- Similar to poultry netting with added horizontal wire strand for protection

MAT Item Number	MAT Product Description	UOM	Size	Weight	Master Pack Qty	Master Pack Wt	Pallet Qty	UPC Code Number	*PROP 65
308481B	Galvanized, 20 gauge	Roll	28" x 25'	3.9	12	37	144	0 99713 38481 1	1

CAGE WIRE

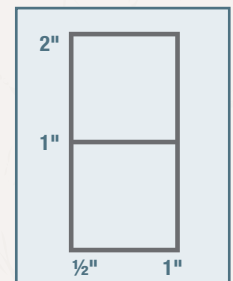

- Great for pet cages, rabbit hutches, plant holders and window well screens
- High quality, galvanized steel, with welded cross wires for added strength
- Made of 16-Gauge galvanized steel

MAT Item Number	MAT Product Description	UOM	Size	Weight	Master Pack Qty	Master Pack Wt	Pallet Qty	UPC Code Number	*PROP 65
309302A	Galvanized, 16 gauge, 1/2" x 1" mesh	Roll	30" x 10'	8.8 lb	6	52.8	90	0 9971303343 6	2
309321A	Galvanized, 16 gauge, 1" x 1" mesh	Roll	36" x 25'	13.1	6	78.6	36	0 9971303344 3	2
309311A	Galvanized, 16 gauge, 1" x 2" mesh	Roll	24" x 15'	7.6	6	45.6	144	0 9971303342 9	2

POULTRY NETTING

A favorite of farmers, pet owners and gardeners, and recognized by its trademark hexagon mesh weave. An economical, lightweight netting often used in pens to confine poultry, rabbits and other small animals.

- Other popular uses include plant protection and support, soil erosion prevention and compost pile confinement
- Made of strong but surprisingly flexible 20 gauge steel
- Galvanized prior to weaving for longer-lasting rust protection
- Each roll individually shrink-wrapped for product protection
- PVC option enhances product longevity and appearance

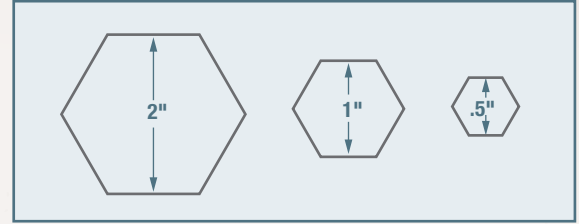

MAT Item Number	MAT Product Description	UOM	Size	Weight	Master Pack Qty	Master Pack Wt	Pallet Qty	UPC Code Number	*PROP 65
308485B	Galvanized, 20 gauge, 1/2" Mesh	Roll	36" x 25'	10.1	6	60.8	120	0 99713 05301 4	2
308484B	Galvanized, 20 gauge, 1/2" Mesh	Roll	24" x 25'	6.8	6	41.1	144	0 99713 05300 7	1
308400B	Galvanized, 20 gauge, 1" Mesh	Roll	24" x 10'	1.6	12	19.6	360	0 99713 03228 6	1
308410B	Galvanized, 20 gauge, 1" Mesh	Roll	36" x 10'	2.4	12	29.1	240	0 99713 03233 0	1
308420B	Galvanized, 20 gauge, 1" Mesh	Roll	48" x 10'	3.2	12	38.4	180	0 99713 03238 5	1
308404B	Galvanized, 20 gauge, 1" Mesh	Roll	24" x 25'	3.9	6	23.4	252	0 99713 03230 9	1
308405B	Galvanized, 20 gauge, 1" Mesh	Roll	36" x 25'	5.8	6	34.8	144	0 99713 03231 6	1
308406B	Galvanized, 20 gauge, 1" Mesh	Roll	48" x 25'	6.9	6	46.2	90	0 99713 03232 3	1
308407B	Galvanized, 20 gauge, 1" Mesh	Roll	60" x 25'	9.5	1	9.5	66	0 99713 03278 1	1
308408B	Galvanized, 20 gauge, 1" Mesh	Roll	72" x 25'	11.4	1	11.4	66	0 99713 03279 8	1
308415B	Galvanized, 20 gauge, 1" Mesh	Roll	12" x 50'	4.0	2	4.0	240	0 99713 03236 1	1
308402B	Galvanized, 20 gauge, 1" Mesh	Roll	18" x 50'	5.8	2	11.5	216	0 99713 03229 3	1
308411B	Galvanized, 20 gauge, 1" Mesh	Roll	24" x 50'	8.0	2	16.0	120	0 99713 03234 7	1
308421B	Galvanized, 20 gauge, 1" Mesh	Roll	36" x 50'	11.2	2	22.5	100	0 99713 03239 2	1
308431B	Galvanized, 20 gauge, 1" Mesh	Roll	48" x 50'	15.2	2	30.3	64	0 99713 03241 5	1
308444B	Galvanized, 20 gauge, 1" Mesh	Roll	60" x 50'	19.0	1	19.0	36	0 99713 03245 3	1
308447B	Galvanized, 20 gauge, 1" Mesh	Roll	72" x 50'	22.7	1	22.7	28	0 99713 03246 0	1
308418B	Galvanized, 20 gauge, 1" Mesh	Roll	12" x 150'	11.9	1	11.9	60	0 99713 03281 1	1
308419B	Galvanized, 20 gauge, 1" Mesh	Roll	18" x 150'	17.2	1	17.2	42	0 99713 03237 8	1

MAT Item Number	MAT Product Description	UOM	Size	Weight	Master Pack Qty	Master Pack Wt	Pallet Qty	UPC Code Number	*PROP 65
308413B	Galvanized, 20 gauge, 1" Mesh	Roll	24" x 150'	22.9	1	22.9	30	0 99713 03235 4	1
308427B	Galvanized, 20 gauge, 1" Mesh	Roll	36" x 150'	33.4	1	33.4	21	0 99713 03240 8	1
308432B	Galvanized, 20 gauge, 1" Mesh	Roll	48" x 150'	45.1	1	45.1	15	0 99713 03242 2	1
308434B	Galvanized, 20 gauge, 1" Mesh	Roll	60" x 150'	56.4	1	56.4	15	0 99713 03243 9	1
308435B	Galvanized, 20 gauge, 1" Mesh	Roll	72" x 150'	67.5	1	67.5	15	0 99713 03244 6	1
308452B	PVC Ctd Green, 20 gauge, 1" Mesh	Roll	24" x 25'	5.1	6	30.7	180	0 99713 03227 9	1
308453B	PVC Ctd Green, 20 gauge, 1" Mesh	Roll	36" x 25'	7.7	6	45.9	120	0 99713 05302 1	1
308456B	PVC Ctd Green, 20 gauge, 1" Mesh	Roll	36" x 50'	14.9	2	29.8	36	0 99713 03283 5	1
308457B	PVC Ctd Green, 20 gauge, 1" Mesh	Roll	48" x 50'	20	2	40	30	0 99713 03286 2	1
308464B	Galvanized, 20 gauge, 2" Mesh	Roll	24" x 25'	1.7	12	20.9	360	0 99713 03250 7	1
308465B	Galvanized, 20 gauge, 2" Mesh	Roll	36" x 25'	2.6	12	3.2	240	0 99713 03251 4	1
308466B	Galvanized, 20 gauge, 2" Mesh	Roll	48" x 25'	3.5	12	41.8	144	0 99713 03252 1	1
308474B	Galvanized, 20 gauge, 2" Mesh	Roll	24" x 50'	3.5	6	20.9	216	0 99713 03253 8	1
308475B	Galvanized, 20 gauge, 2" Mesh	Roll	36" x 50'	5.2	6	31.2	144	0 99713 03254 5	1
308476B	Galvanized, 20 gauge, 2" Mesh	Roll	48" x 50'	6.9	6	41.7	108	0 99713 03255 2	1
308478B	Galvanized, 20 gauge, 2" Mesh	Roll	60" x 50'	8.9	1	8.9	66	0 99713 03256 9	1
308479B	Galvanized, 20 gauge, 2" Mesh	Roll	72" x 50'	10.4	1	10.4	66	0 99713 03257 6	1
308493B	Galvanized, 20 gauge, 2" Mesh	Roll	18" x 150'	7.8	1	7.8	90	0 99713 03258 3	1
308494B	Galvanized, 20 gauge, 2" Mesh	Roll	24" x 150'	10.4	1	10.4	90	0 99713 03259 0	1
308495B	Galvanized, 20 gauge, 2" Mesh	Roll	36" x 150'	15.4	1	15.4	45	0 99713 03260 6	1
308496B	Galvanized, 20 gauge, 2" Mesh	Roll	48" x 150'	21.2	1	21.2	45	0 99713 03261 3	1
308497B	Galvanized, 20 gauge, 2" Mesh	Roll	60" x 150'	26.0	1	26.0	28	0 99713 03262 0	1
308498B	Galvanized, 20 gauge, 2" Mesh	Roll	72" x 150'	30.8	1	30.8	28	0 99713 03263 7	1

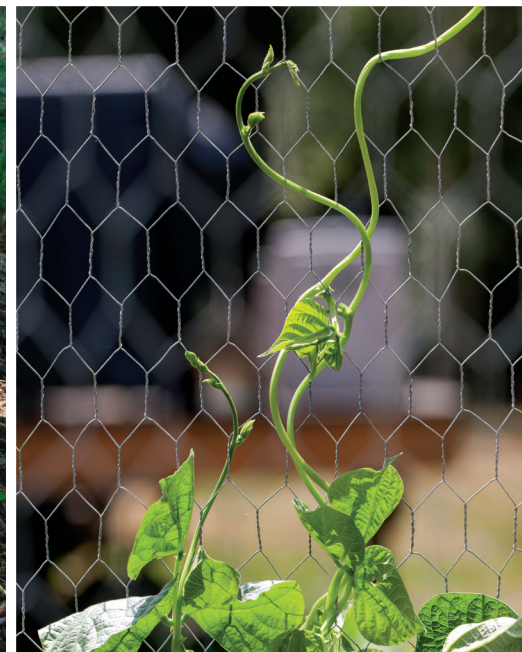

MERCHANDISERS & PACKAGING

- No wasted space. Simply expand or reduce display space according to seasonal needs
- Hardware components adjust easily for regionally-targeted product assortments
- Heavy-Duty steel components with durable white powder coat finish
- Ideal alternative to one-size-fits-all merchandising solutions
- Moves and sets up easily to accommodate floor plan changes
- Products are kept neat and organized
- Assembly instructions included
- Includes eye-catching signage



P-O-P & Packaging
(Easy to open box for quick setup!)

FENCING SOLUTION CENTER

- Adjustable display depths accommodate various gondola shelf and base depths
- Reposition-able and depth adjustable dividers allow easy assortment changes
- Fence rolls are displayed vertically to optimize merchandising space
- Heavy-duty steel components with durable powder coat finish
- Great versatility work with various planograms
- Products are kept organized

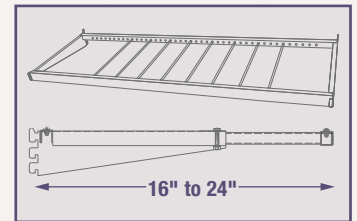

Adjustable display depths: 16",
18", 19", 20", 22" and 24"





CODE # *PROP 65 WARNING

- 1 WARNING: CONTAINS LEAD. May be harmful if eaten or chewed. May generate dust containing lead. Wash hands after use. Keep out of reach of children. ⚠ WARNING: Cancer and Reproductive Harm - www.P65Warnings.ca.gov.
- 2 ⚠ WARNING: Cancer and Reproductive Harm - www.P65Warnings.ca.gov.
- 3 ⚠ WARNING: Reproductive Harm - www.P65Warnings.ca.gov
- 4 ⚠ WARNING: This product can expose you to chemicals including chromium, which is known to the State of California to cause cancer and birth defects or other reproductive harm. For more information go to www.P65Warnings.ca.gov.
- 5 No warning required

FOR MORE INFORMATION ABOUT OUR PRODUCTS OR TO REQUEST A CATALOG: 1-800-628-8815



CHAIN LINK, PLASTIC & WIRE FENCING



LAWN & GARDEN



6700 WILDLIFE WAY
LONG GROVE, IL 60047

ID11483_091719