

# APOLLO



EXPORTS INTERNATIONAL INC.

BRINGING UNIQUE PRODUCTS TO  
MARKET SINCE 1992



New Privacy Planters Pg 5

**OUTDOOR  
2024**



## ADJUSTABLE RAILING PLANTERS

### NO TOOLS REQUIRED – FITS ANY TYPE OF RAIL OR FENCE!

Beautify your decks and fences with these ingenious adjustable railing planters that work on metal balconies, rounded composite and standard wood railings - they even work on chain link fences! No tools required. Made from UV-protected resin.

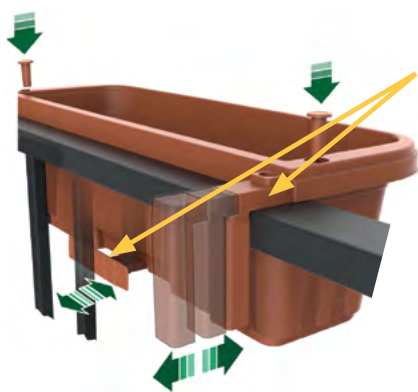

### ADJUSTABLE ARMS & LEVELING FOOT

Adjust the arms to fit over rail, lock in place with the included pins and pull out leveling foot to keep planter perfectly level, regardless of the fit.



### BUILT-IN WATER RESERVOIR & SLOTTED TRAY

Excess water sits in the lower reservoir with 1" overflow. Hidden tray separates plants from reservoir with slits to allow only the roots to reach the water below, avoiding root rot.

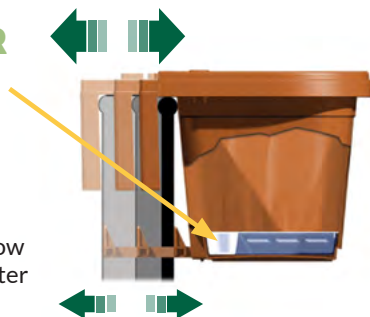





20"  
**AP-30217X**



- | X CODE  | COLOR       |
|---|-------------|
|  TC | Terra Cotta |
|  WH | White       |
|  DW | Driftwood   |

24"  
**AP-30218X**



- | X CODE   | COLOR       |
|--|-------------|
|  TC | Terra Cotta |
|  GR | Green       |
|  WH | White       |
|  DW | Driftwood   |
|  BK | Black       |

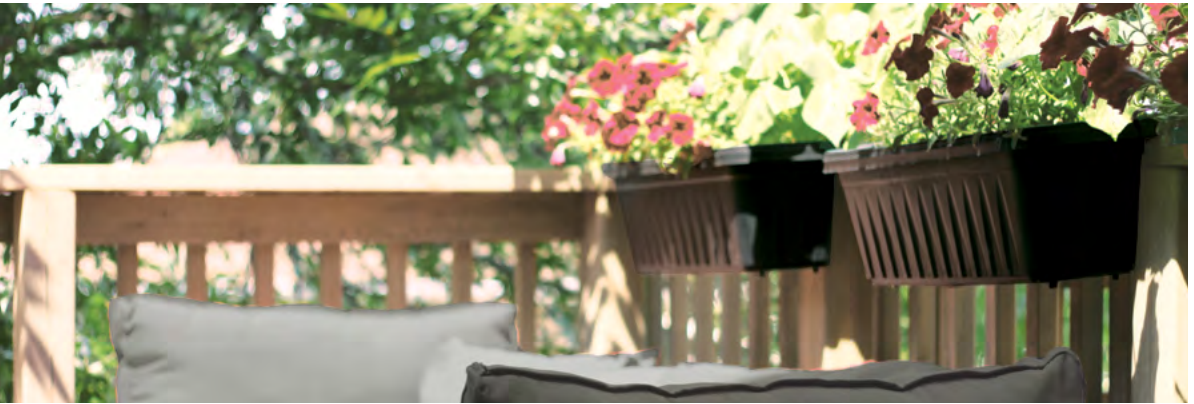

32"  
**AP-302X**



- | X CODE  | COLOR       |
|---|-------------|
|  TC | Terra Cotta |
|  GR | Green       |
|  WH | White       |

**Includes 3 adjustable support arms & 2 leveling feet**



Case pack includes a header card and option to remove the perforated front, for easy access!



ITEM #	PRODUCT TITLE	COUNTRY OF ORIGIN	ASSEMBLED UNIT SIZE	CASE PACK
AP-30217X	20" Adjustable Railing Planter	Italy	20"L x 8"W x 7.5"H	24
AP-30218X	24" Adjustable Railing Planter	Italy	24"L x 8"W x 7.5"H	24
AP-302X	32" Adjustable Railing Planter	Italy	32"L x 8"W x 7.5"H	14



**Fits  
1" to 5 1/2"  
Railing**



# 16" DOUBLE SIDED ADJUSTABLE RAILING PLANTER SET

CONNECT OVER ANY TYPE OF RAILING  
LOOKS GREAT FROM BOTH SIDES



Bring your deck and fence railings alive with the beauty of flowers. The planters connect over top all types of railings from metal to rounded composite to standard wooden railings, they even work on chain link fences! No tools required. Made from UV-protected resin.

## ADJUSTABLE ARMS & LEVELING FOOT

Connect the planters using the adjustable arms to fit over rail, lock in place using included pins, and pull out leveling foot from both planters to keep them perfectly level, regardless of fit

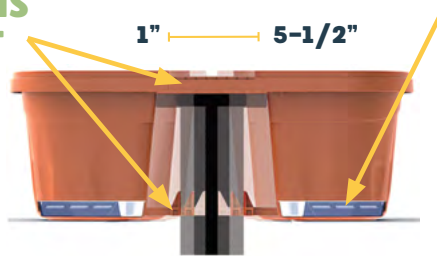

## BUILT-IN WATER RESERVOIR & SLOTTED TRAY

Excess water sits in the lower reservoir with 1" overflow. Hidden tray separates plants from reservoir with slits to allow only the roots to reach the water below, avoiding root rot.



ITEM #	PRODUCT TITLE	COUNTRY OF ORIGIN	ASSEMBLED UNIT SIZE	CASE PACK
AP-30230	16" Double Sided (Terra Cotta)			
AP-30231	16" Double Sided (Green)	Italy	16"L x 8"W x 7.5"H (x2)	21
AP-30232	16" Double Sided (White)			



Fits 1" to 4" Railing

**NEW!**

## PRIVACY PLANTERS (SET OF 2)

### ADJUSTABLE RAILING PLANTERS WITH TRELLIS!

Add instant privacy from your deck or balcony! Each planter has a rattan finish and adjusts to fit any type of railing from 1" - 4"; including metal balconies, rounded composite and standard wooden railings - even chain link fences! No tools required!

Adjust the arms to fit over rail, lock in place with the included pins and pull out leveling foot to keep planter perfectly level. Then snap trellis together and into back of planter. Each planter has a built-in water reservoir with 1" overflow and hidden tray separates plants from reservoir with slits to allow only the roots to reach the water below, avoiding root rot. Grow your privacy naturally by planting flowering vines! Made from UV-protected resin.



- 
- 
- 
- 
- 
- 

ITEM #	PRODUCT TITLE	COUNTRY OF ORIGIN	ASSEMBLED UNIT SIZE	CASE PACK
AP-30320	24" Privacy Planters, S/2 (White)	Italy	24"L x 8.5"W x 25"H (x2)	1
AP-30321	24" Privacy Planters, S/2 (Grey)			



Keep your plants moist for up to 2 weeks!

# EEZY-GRO® SELF WATERING PLANTERS & HANGING BASKETS

**PLANTS HAVE THE ABILITY TO SELF-WATER!**

The internal wick system draws water from the reservoir when the soil starts to dry and delivers it directly to the plant roots for optimal absorption. No more over/under watering! Made from UV-protected resin.

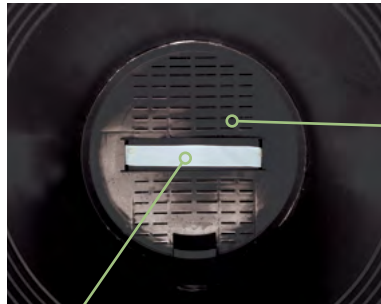
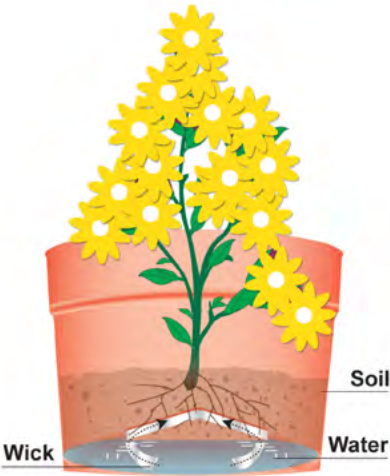

**VENTED ROOT SAVER BOTTOM** that aerates the soil and root systems.



**FILL RESERVOIR FROM THE SIDE**

The **INTERNAL WICK SYSTEM** draws water up from reservoir to the soil above



Black



Driftwood



Terra Cotta



Olive



White



Mocha



Hanging Basket  
**AP-4133X**



X CODE	COLOR
BK	Black
DW	Driftwood
TC	Terra Cotta
OL	Olive
WH	White
MO	Mocha



12"  
**AP-44527X**



10"  
**AP-44526X**



8"  
**AP-44525X**



ITEM #	PRODUCT TITLE	COUNTRY OF ORIGIN	ASSEMBLED UNIT SIZE	CASE PACK
AP-44525 X	8" EEZY-GRO® Self Watering Planter	USA	10" Diam. x 8"H	6
AP-44526 X	10" EEZY-GRO® Self Watering Planter	USA	12" Diam. x 10"H	6
AP-44527 X	12" EEZY-GRO® Self Watering Planter	USA	14" Diam. x 12"H	6
AP-4133 X	12" EEZY-GRO® Self Watering Hanging Basket	USA	12" Diam. x 6.5"H	6



## HOME DEK-DECOR® ON-RAILING PLANTERS FOR 4" & 6" WIDE RAILINGS

Bring the beauty of your flowers up close to enjoy while sitting on a deck or patio and make the most of your valuable deck space by placing these planters on either a 4" or 6" railing and your done - no tools required! These planters are taller and wider than most giving you even more space for your favorite flowers to blossom. Drainage holes prevent over watering and root rot. Made from UV-protected resin. Available in 12 different colors.

ITEM #	PRODUCT TITLE	COUNTRY OF ORIGIN	ASSEMBLED UNIT SIZE	CASE PACK
AP-4132R4 X	25" Deck Planter - 4" Rail	USA	25" x 11" x 8"H	6
AP-4132R6 X	25" Deck Planter - 6" Rail	USA	25" x 11" x 8"H	6
AP-4231L4 X	30" Deck Planter - 4" Rail	USA	30" x 11" x 9"H	6
AP-4231L6 X	30" Deck Planter - 6" Rail	USA	30" x 11" x 9"H	6
AP-5720 X	25" Dual Deck Rail Planter - 4" or 6" Rail	USA	25" x 11" x 9"H	6
AP-5720PC	25" Dual Deck Rail Planters 72pc Display (12 each x 6 colors)	USA	25" x 11" x 9"H	72





4" Rail Planter  
**AP-4132R4**X (25"L)  
**AP-4231L4**X (30"L)



6" Rail Planter  
**AP-4132R6**X (25"L)  
**AP-4231L6**X (30"L)















Dual Deck Rail Planter  
**AP-5720**X (25"L)

Dual Deck Rail Planter Floor Display  
**AP-5720PC**

Check out our best selling special 1/2 pallet display of 72 pcs of the Dual Deck Rail Planter - 6 colors X 12 each. Pallet display measures 48"W x 26"D x 36"H.



**12 COLORS TO CHOOSE**

X CODE	COLOR	X CODE	COLOR	X CODE	COLOR
 TQ	Turquoise	 GR	Green	 BK	Black
 MG	Margarita	 YE	Yellow	 BL	Blue
 CB	Cabernet	 TC	Terra Cotta	 WH	White
 DW	Driftwood	 OL	Olive	 MO	Mocha





Terra Cotta  
**AP-30015**

## TRIFOGLIO 3-TIER PLANTER ON WHEELS GREAT FOR SMALL SPACES!

Love to garden but don't have the space? This is the perfect solution - 3 levels, 3 pods per level for a total of 9 separate pods to grow your favorite herbs and flowers. Securely stacked on a rolling saucer so you can easily move it in and out of the sun and rain as needed. No tools required. Made from UV-protected resin.

Green  
**AP-30017**



Grey  
**AP-30018**

ITEM #	PRODUCT TITLE	COUNTRY OF ORIGIN	ASSEMBLED UNIT SIZE	CASE PACK
AP-30015	Trifoglio 3-Tier Planter (Terra Cotta)			
AP-30017	Trifoglio 3-Tier Planter (Green)	Italy	16" x 16" x 20"H	1
AP-30018	Trifoglio 3-Tier Planter (Grey)			



Terra Cotta  
**AP-32000**

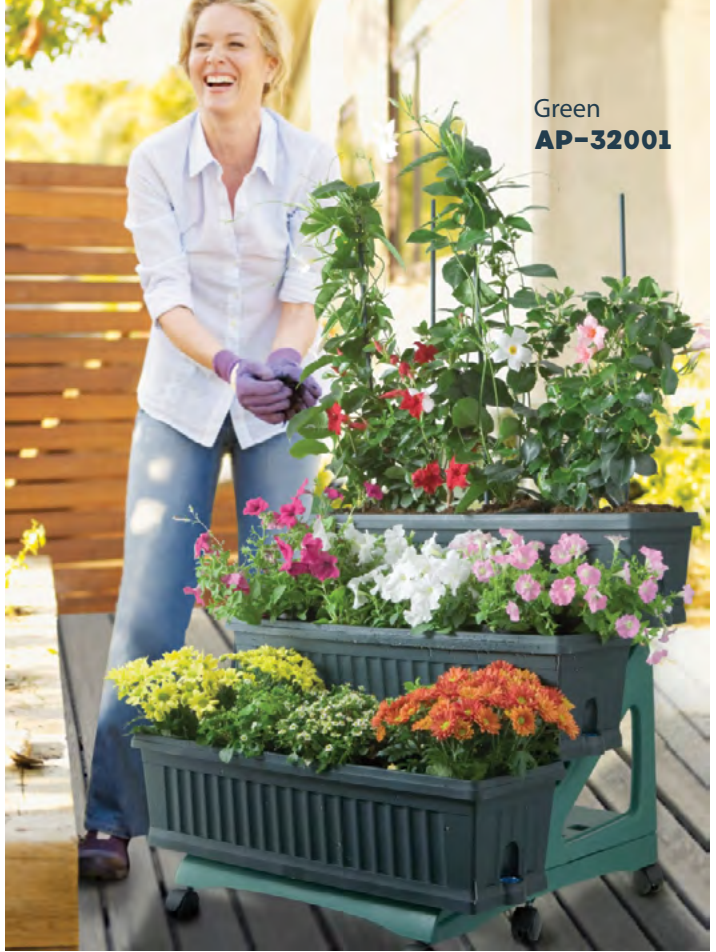

Green  
**AP-32001**



## ROLLING PATIO GARDEN

### A THREE-TIER GARDEN THAT ROLLS WITH EASE

Introducing three generously-sized planters securely stacked on a convenient rolling stand. Every tray enjoys ample sunlight and natural rain, with the top tray featuring support spikes for taller plants. Whether it's flowers, herbs, or veggies, you can cultivate your favorites. Each tray cleverly conceals a hidden water reservoir, and there is even a storage space behind for your gardening essentials—gloves, tools, watering cans, fertilizers—all within arm's reach. It's the perfect compact garden for those with limited space! Made from UV-protected resin.



SEE IT IN  
**ACTION!**

ITEM #	PRODUCT TITLE	COUNTRY OF ORIGIN	ASSEMBLED UNIT SIZE	CASE PACK
AP-32000	Rolling Patio Garden (Terra Cotta)	Italy	32"W x 29"D x 29"H	1
AP-32001	Rolling Patio Garden (Green)			

Brown  
**AP-32022**



## THE BRICK MODULAR 5-PC PLANTER SET

### SWIVEL THE CONNECTING PLANTERS TO FIT ANY SPACE

Configure this set of 5 planters any way you want to bring any space to life - indoors or outside - from wasted corners of your deck to empty spaces along a wall. Built-in irrigation system makes watering a breeze (see graphic below). Each planter includes water leveling indicator. Made from UV-protected resin.



Grey  
**AP-32020**



ITEM #	PRODUCT TITLE	COUNTRY OF ORIGIN	ASSEMBLED UNIT SIZE	CASE PACK
AP-32020	Brick Modular 5-pc Planter Set (Grey)			
AP-32021	Brick Modular 5-pc Planter Set (White)	Italy	24"L x 9"W x 11"H (x5)	1
AP-32022	Brick Modular 5-pc Planter Set (Brown)			

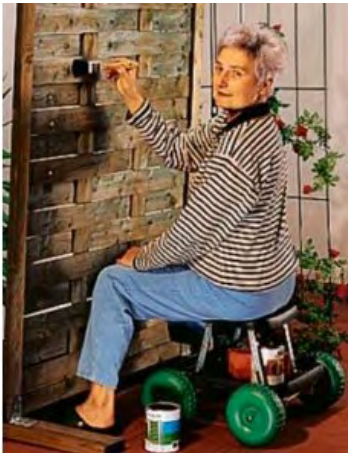
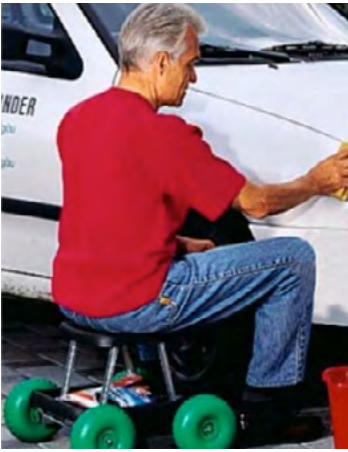

## ROLLING WORK SEAT

### TAKE THE BACK PAIN OUT OF ALL THE JOBS!



As we age, it sure doesn't get any easier on our backs, knees, and hips when it's time to get to work. Gardening for example, is a wonderful past time, but it sure can be a challenge getting down to ground level. Have a painting job? Again, not easy working on that floor trim. Even washing your car can be tough. Time to say goodbye to these challenges with this handy rolling seat, that allows you to sit comfortably and extra wide wheels that easily roll over grass and uneven ground. Keep your tools handy on the storage tray underneath. Made from durable plastic and steel frame.

ITEM #	PRODUCT TITLE	COUNTRY OF ORIGIN	ASSEMBLED UNIT SIZE	CASE PACK
AP-HM05457	Rolling Work Seat	Taiwan	19" x 18.5" x 13"	1

SEE IT IN  
  
ACTION!

Covers  
up to  
1900 sq. ft



## RAINFOREST SPRINKLERS USE UP TO 1/3 LESS WATER

Revolutionary sprinklers use up to 1/3 less water compared to conventional sprinklers and cover up to 1900 sq. ft (50 foot diameter spray). Heart-shaped head shatters water droplets into a fine rain/ mist that will not damage your plants or seedlings while improving water delivery to the root zone. Will not clog, so ideal for well systems and areas with hard water. Works on high and low water pressures. 6ft tripod has extendable legs, which work great on uneven surfaces.



ITEM #	PRODUCT TITLE	COUNTRY OF ORIGIN	ASSEMBLED UNIT SIZE	CASE PACK
AP-00107	12" Rainforest w/2 way Spike	Taiwan	12" H	12
AP-00601	3ft Rainforest Tripod Sprinkler	Taiwan	36" H	12
AP-00600	6ft Rainforest Tripod Sprinkler	Taiwan	72" H (extendable)	6



# SHAPES ALIVE

The Connecting Planter Set

Turn your blah fence or gate into something spectacular!



14  
POD SET

## SHAPES ALIVE 14-POD CONNECTING PLANTER SET

Bring your fence or gate to life with our 14-POD connecting planter set! Connect any way you want to create any shape you want (including monograms). You get 14 pods to work with. Super easy to setup - takes less than 5 minutes - all of the pods snap together and you only have to screw in a few anchor points for support (wood screws included). Each pod consists of 1 base (7" sq.) and 1 vase (7"W x 3.5"D x 3.5"H). Made from UV-protected resin.



NEW!

Create any shape, letter or number!

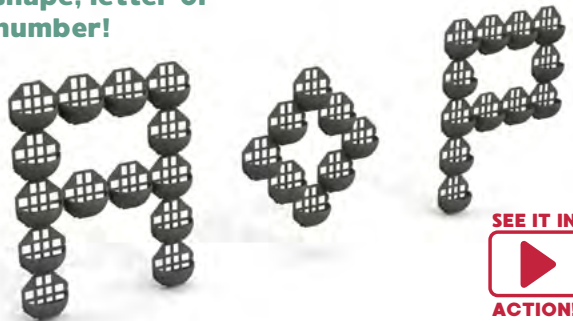

SEE IT IN  
ACTION!

ITEM #	PRODUCT TITLE	COUNTRY OF ORIGIN	ASSEMBLED UNIT SIZE	CASE PACK
AP-1107	Shapes Alive 14-Pc Connecting Planter Set	Italy	36"L x 4.5"W x 36"H	1

**APOLLO EXPORTS INTERNATIONAL INC.**

30 Quarry Ridge Rd.  
Barrie, ON L4M 7G1  
905.847.2643

**[www.ApolloExports.com](http://www.ApolloExports.com)**