

ACHLA[®]



DESIGNS

2024
30th Edition



Handcrafted Accessories
for the Home & Garden

www.achla.com

978 343 7475

NO PRICE INCREASES FOR 2024

2024 Greetings!

Wishing everyone a wonderful gardening season ahead, we present our latest offerings, including new introductions in birdbaths, plant stands, plant supports and flower box trays. While shipping costs have stabilized, this year we face a different challenge of inflation. With that in mind, we have elected to keep our dealer prices the same for the coming year. This 2024 Catalog, marks our 30th edition! As always, all products are ready for shipment from our warehouse and our customer service team is here to help.

We sincerely appreciate this continued partnership with you, our customers, for all this time. We aspire to serve your needs, bringing beautiful, functional, quality products to consumers.

Achla Bahl Madan
Ashok Hingorany
Ruchika Madan

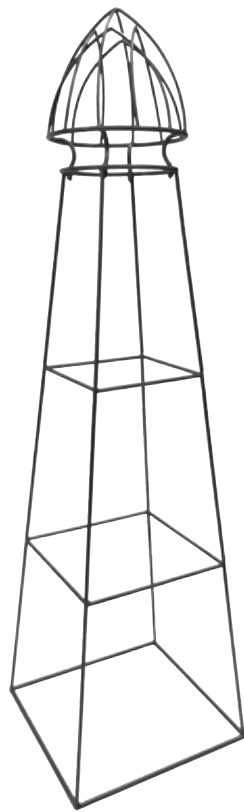

PYL-21 Minar Pylon I
see [pg. 22](#)

Our Team:

Randy West, Marketing
Diane Shattuck, Controller
Elizabeth Garside, Graphic Designer
Kent Yang, IT System Administrator Specialist
Robyn Kirby, Roberta Tomer, Jenifer Adams,
Janine Marceau & Tyler Hallett, Customer Service

info@achla.com
978-343-7475

Showroom: The Gardens & Outdoor Living
9th Floor, Building 2, #9-7A AmericasMart, Atlanta GA



C-20W Medium Cape Cod White Flower Box
see [pg. 69](#)



FB-76 Catalina Plant Stand
see [pg. 34](#)

Arbors

Create an elegant garden entrance with a handcrafted Achla Designs wrought iron arbor. These arbors are sturdy enough to support climbing vines with ample room for passage beneath. Designed to ship flat and easily erected, many of our arbors use only slip-in components. For installation in-ground or hardscapes.

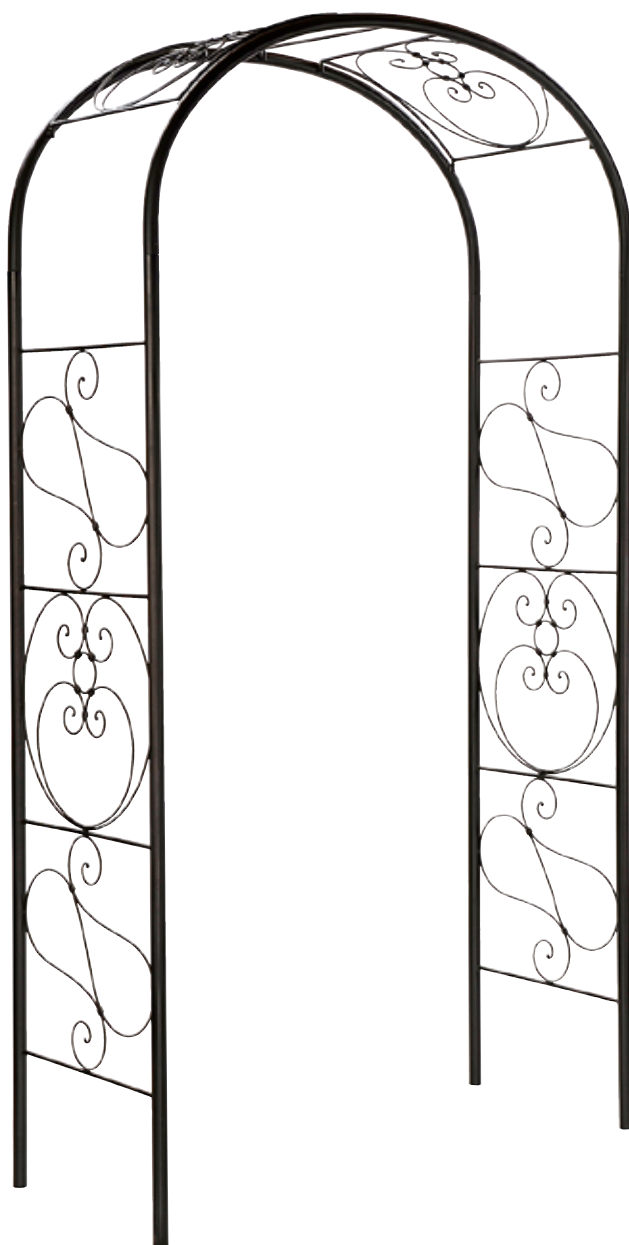

ARB-27 Ferro Firenze Arbor
55"W x 22"D x 99"H *Roman Bronze*

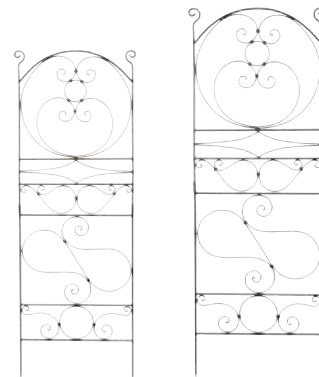

ARB-27 Matches our Ferro Firenze trellises, FT-27 and FT-28 on [pg. 11](#) Combine all three to complete an Italianate garden theme.

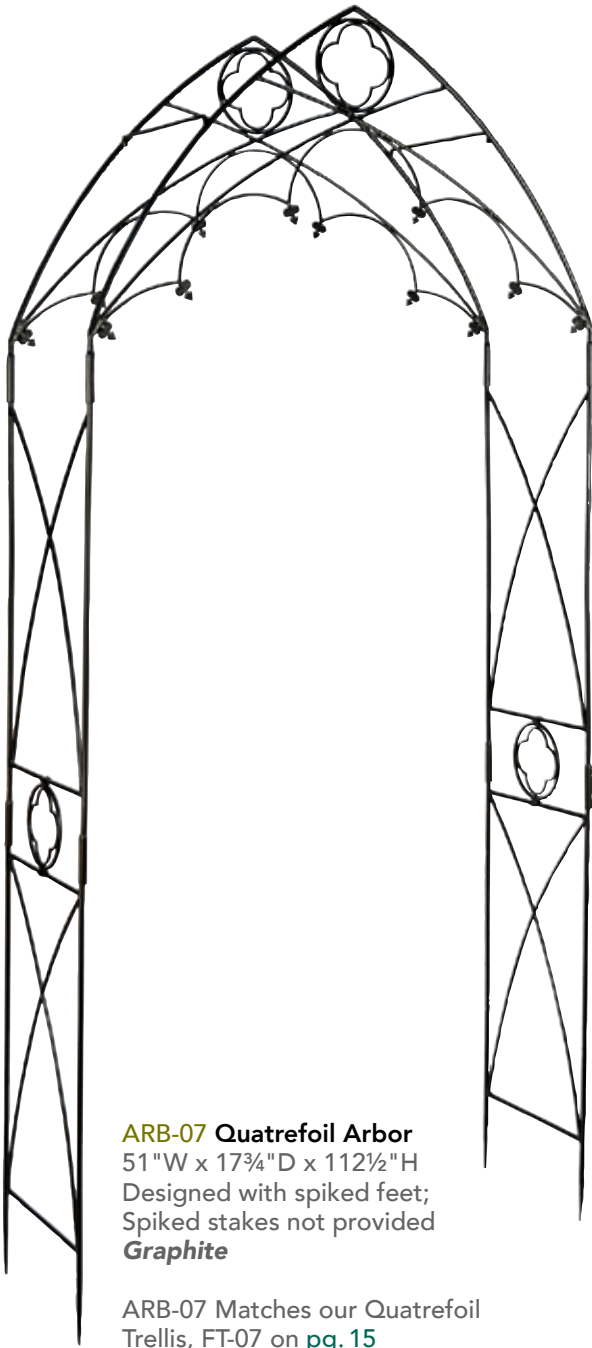

ARB-07 Quatrefoil Arbor
51"W x 17¾"D x 112½"H
Designed with spiked feet;
Spiked stakes not provided
Graphite

ARB-07 Matches our Quatrefoil
Trellis, FT-07 on [pg. 15](#)



AR-01 Arbor Bench
39½"W x 16"D x 26½"H
Black

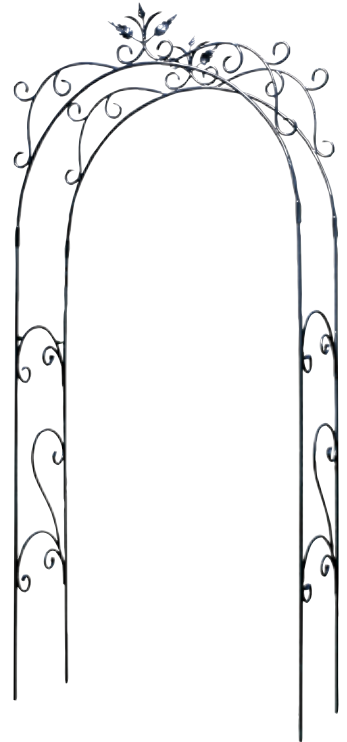

ARB-01 Tuileries Arbor
48"W x 16"D x 113"H
Spiked stakes not provided
Graphite





ARB-40 Tuscany Arbor
 66¼"W x 21"D x 84"H
 (54¾ opening width)
 Set of 4 spikes included
Graphite

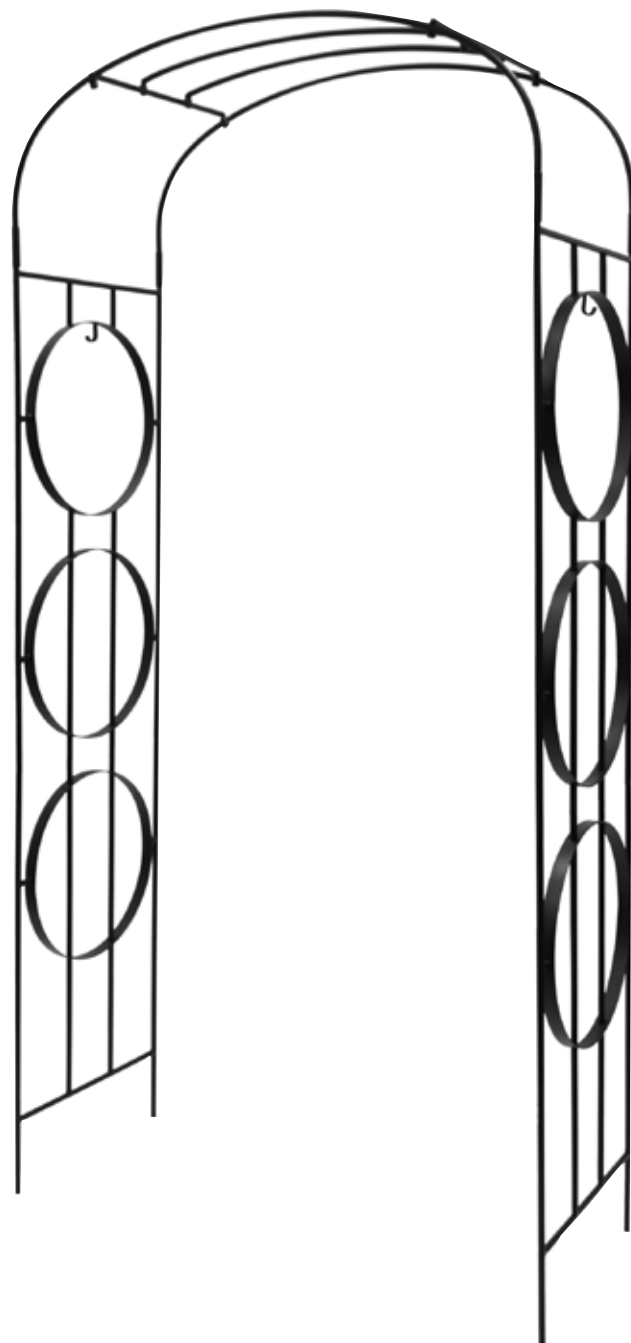
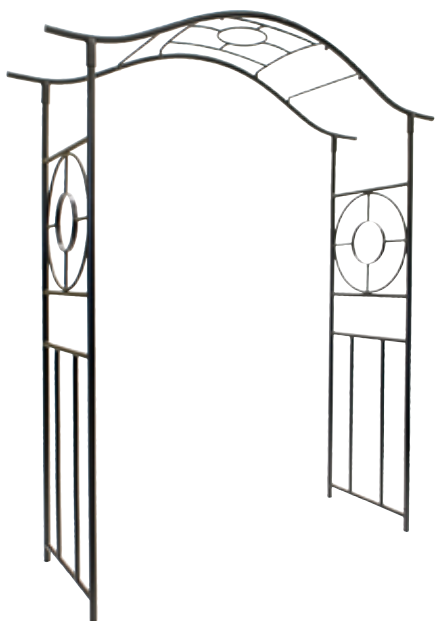

ARB-58 Samsara Arbor
 44"W x 19"D x 92¼"H
 Set of 4 spikes included
Black



ARB-58 Matches our Samsara Trellis, FT-58 on [pg. 18](#)

All wrought iron items have a powder coated finish

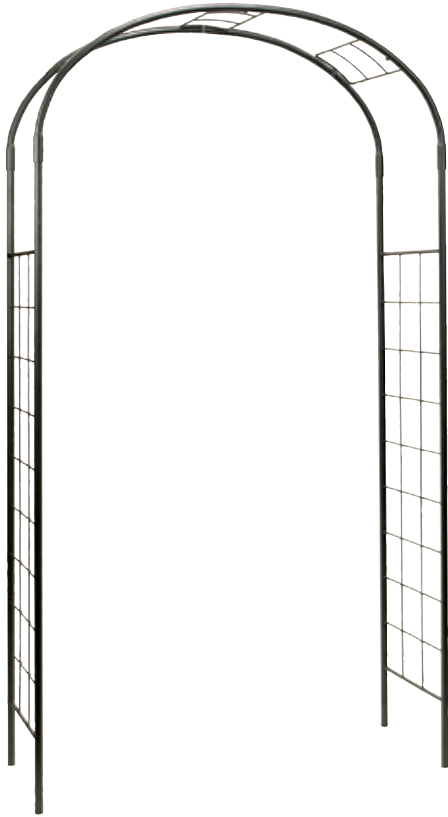

ARB-10 Monet Arbor
55"W x 21"D x 100"H
Set of 4 spikes included
Graphite

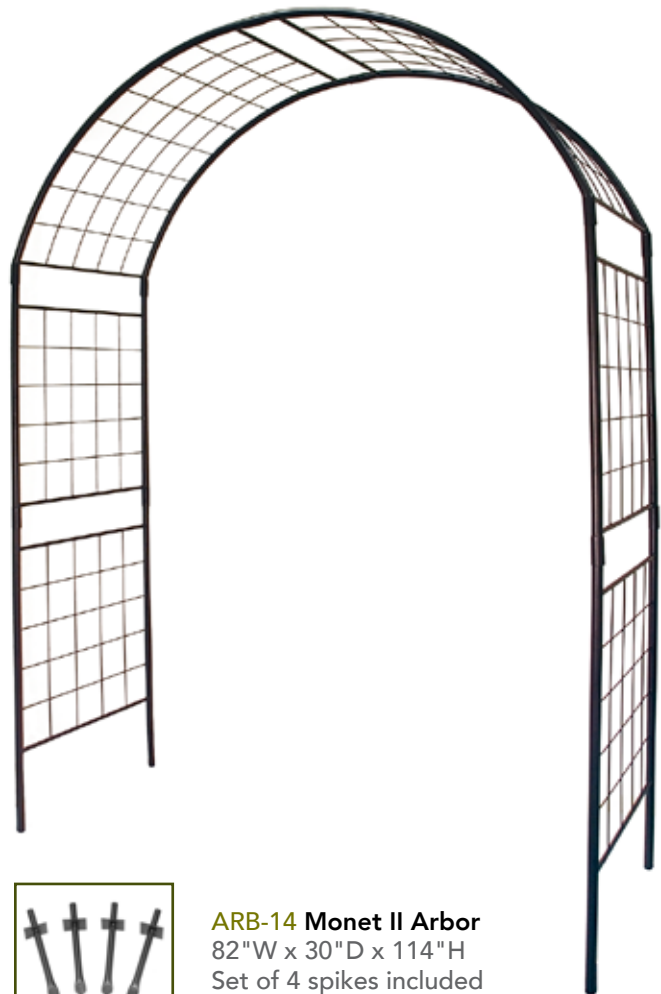

ARB-14 Monet II Arbor
82"W x 30"D x 114"H
Set of 4 spikes included
Graphite

Cottage Collection

The Lattice Arbors have smooth curves with a traditional argyle pattern. Complete the Cottage Garden look with Lattice Trellises on [pg. 20](#) and the Lattice Obelisk [pg. 22](#).



ARB-32G Lattice Tunnel Arbor
 61¼"W x 33"D x 106"H
 Requires tools for assembly
 Set of 4 spikes included
Graphite

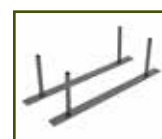
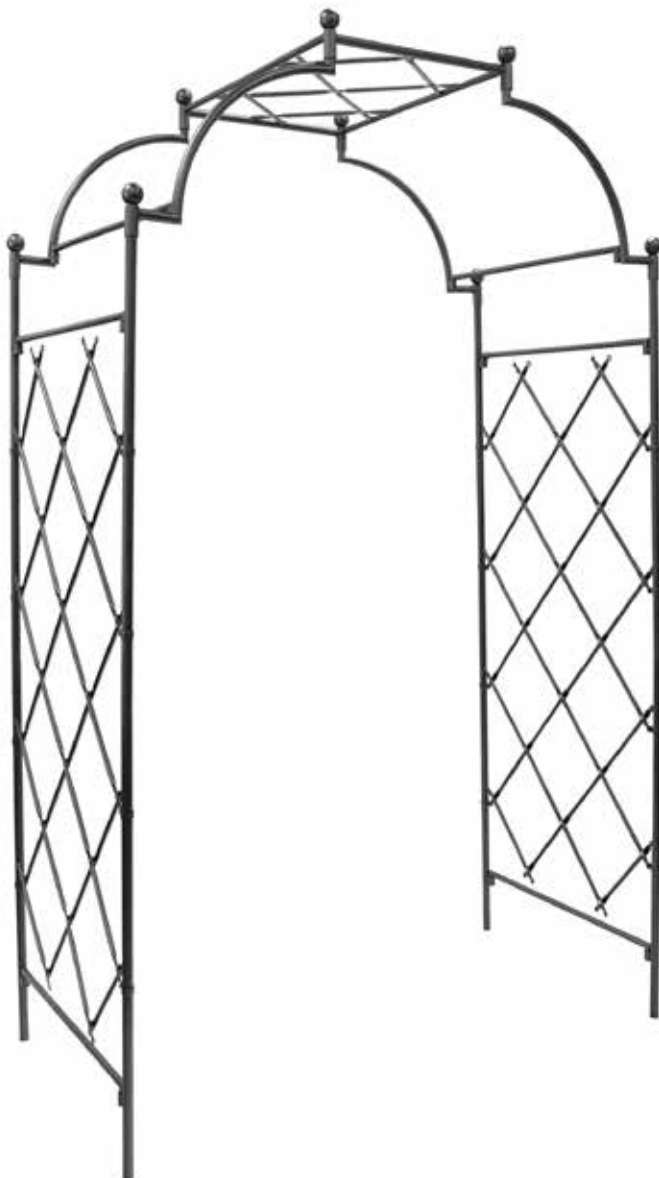

ARB-30G Lattice Arbor I
 41"W x 21"D x 92"H
 Includes display feet
 instead of spiked stakes
Graphite

Square-on-Squares Collection

The design concept of this collection has a simple design concept based on modern architecture's fascination with repeating right-angle shapes. The various pieces available in this group can be used to create a unified modern landscape theme.

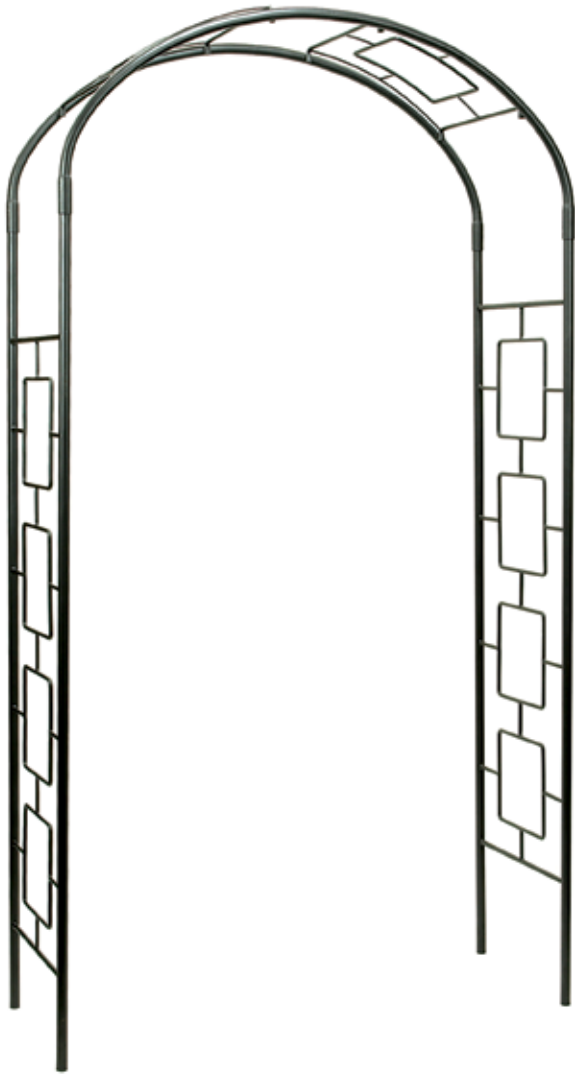

ARB-11 Modern Arbor
55"W x 21"D x 100"H
Set of 4 spikes included
Graphite

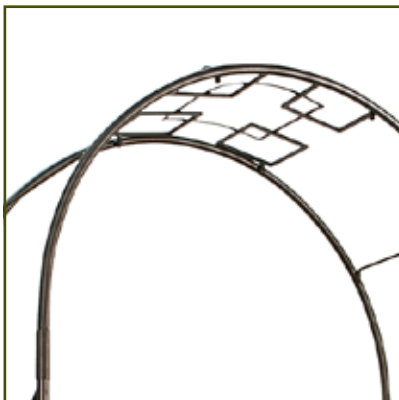

Closeup of ARB-25

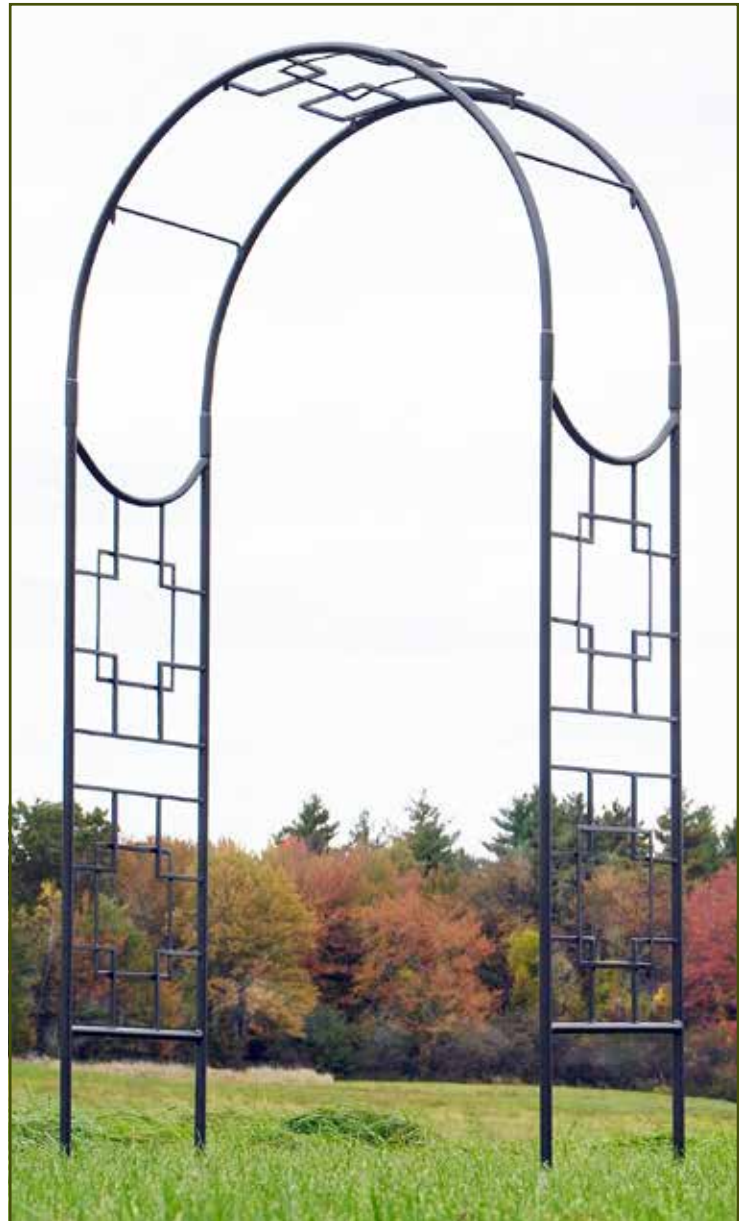

ARB-25 Square-on-Squares Arbor
52"W x 22"D x 98"H
Set of 4 spikes included
Graphite

All wrought iron items have a powder coated finish

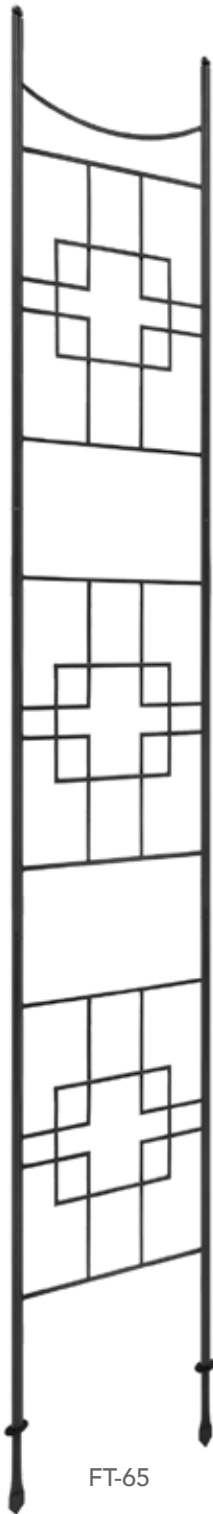

FT-65



Two wall brackets included with FT-65 trellis

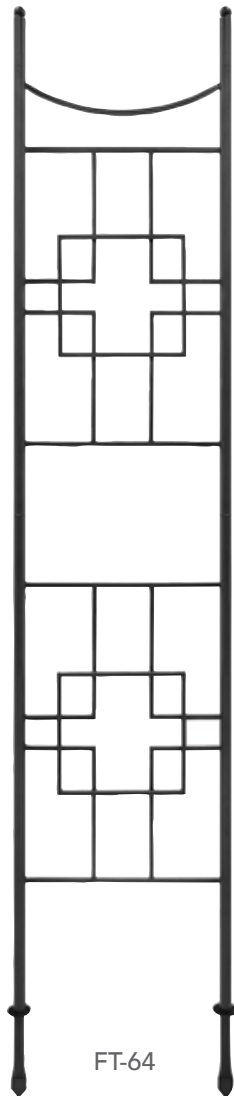

FT-64

PYL-25 Pylon
 12"W sides, 60"H;
 Basket: 10"D x 24" dia.
 Includes PYL-25L Contoured Jute Liner for the basket (also sold separately)
Graphite

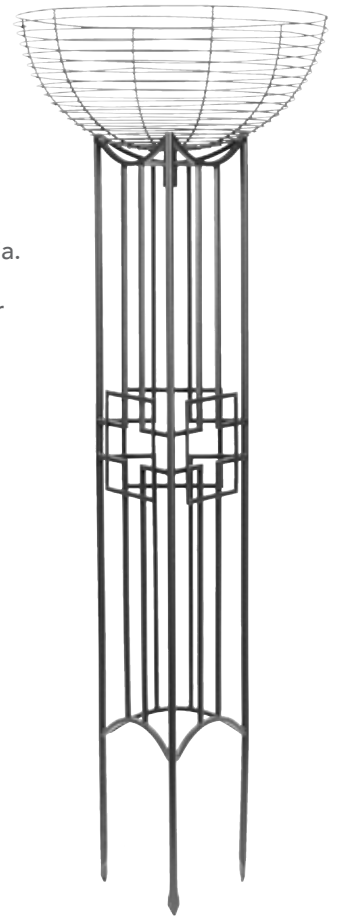

PYL-25L Jute Liner
 for PYL-25 Pylon



Square-on-Squares Slim Trellises Graphite

FT-65 135" Slim Trellis
 18½"W x 1"D x 135"H
 Includes three sections, spiked feet, and trellis support brackets

FT-64 96" Slim Trellis
 18½"W x 1"D x 96½"H
 Includes two sections and spiked feet



ARB-26

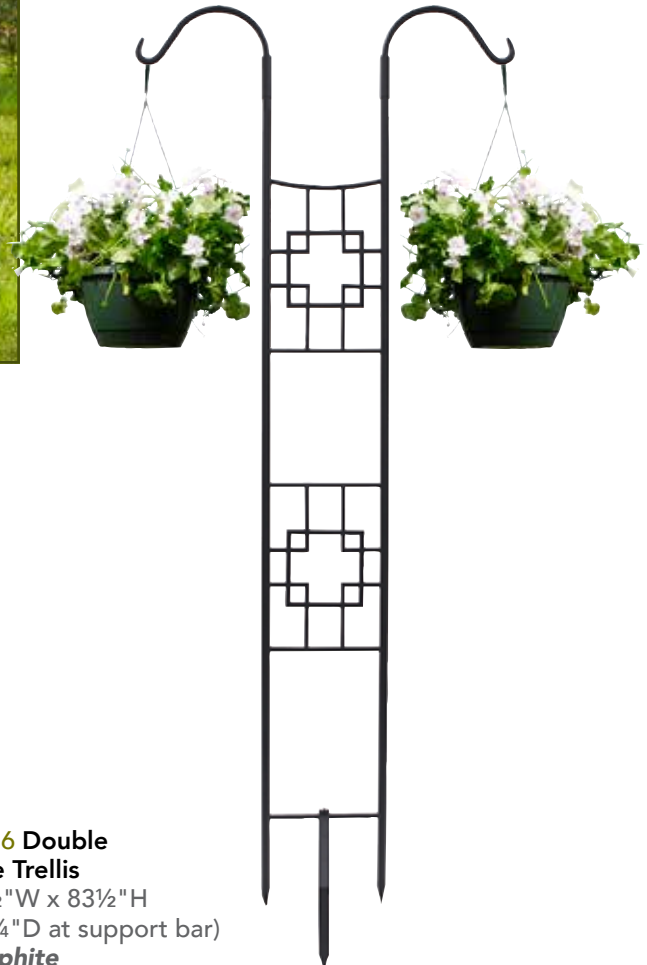
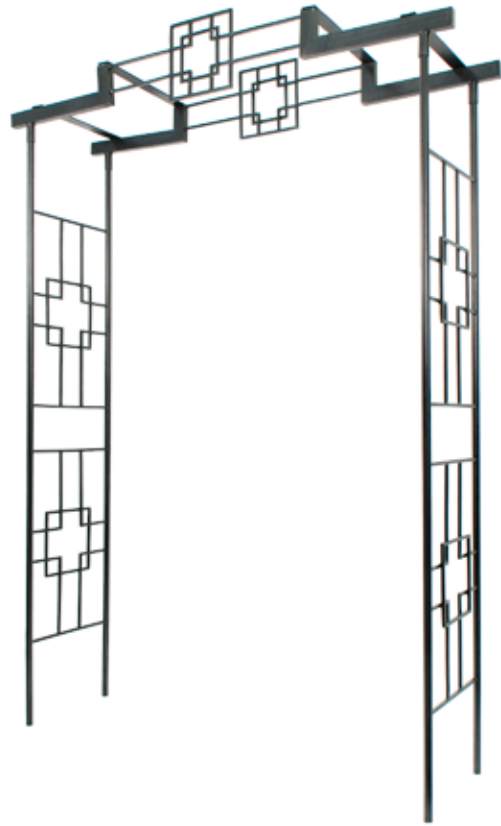

ARB-26 Square-on-Squares Arbor II
 61"W x 18½"D x 95½"H
 Top: 67"W
 Set of 4 spikes included
Graphite

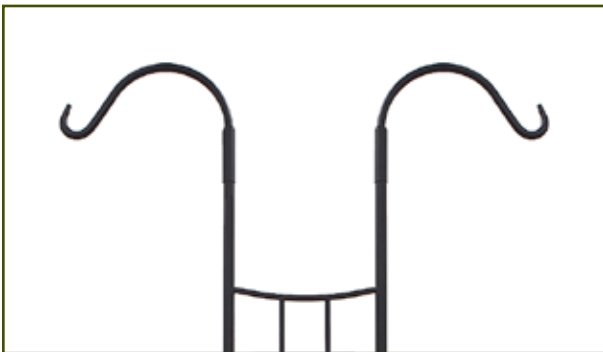

FT-26 Double Pole Trellis
 31½"W x 83½"H
 (11¼"D at support bar)
Graphite

All wrought iron items have a powder coated finish

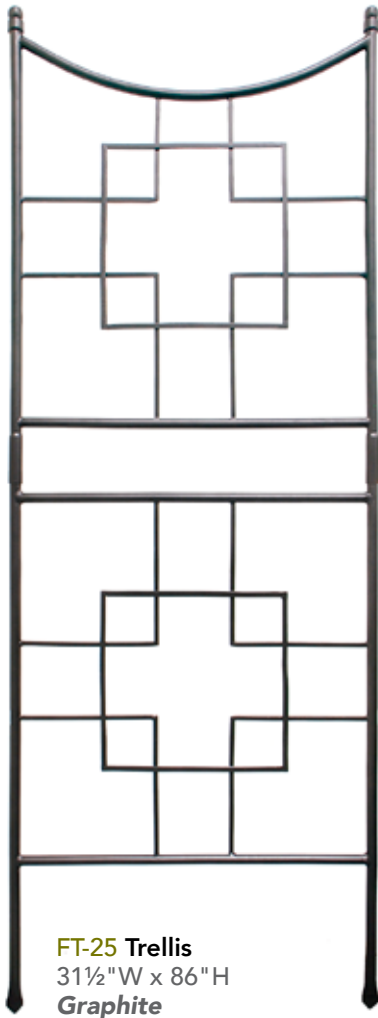

FT-25 Trellis
31½"W x 86"H
Graphite

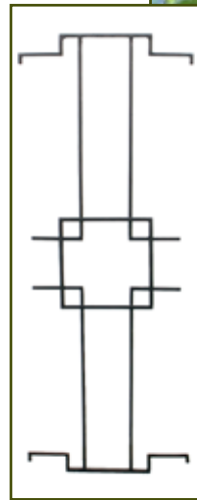
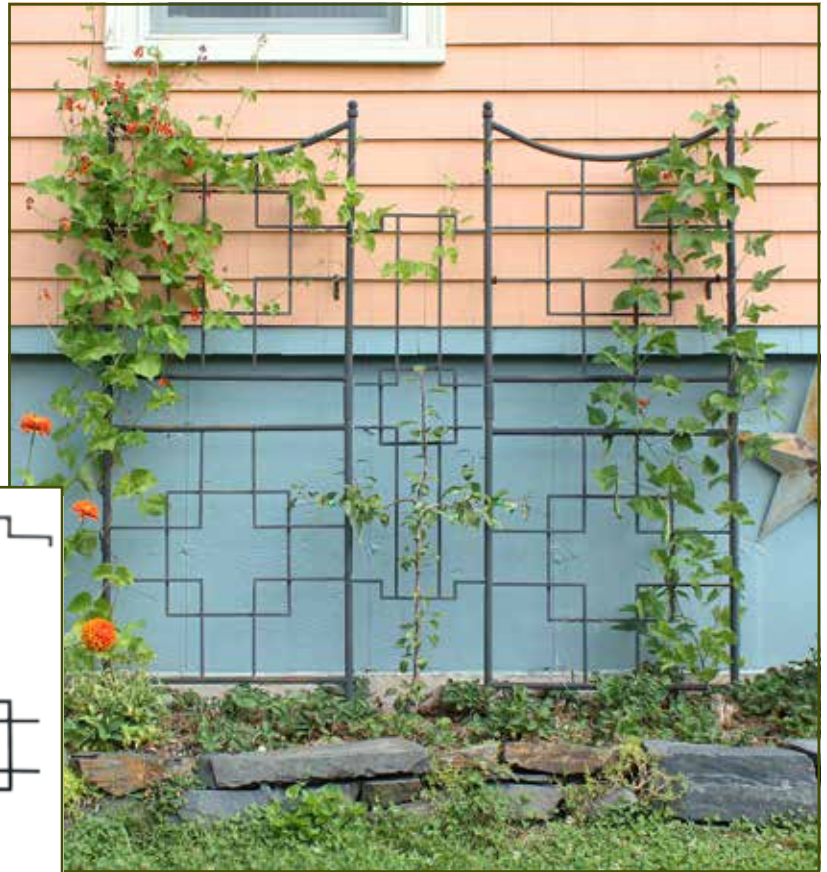

FT-24 Center Link 18"W x 48"H
Hangs from two FT-25 Trellises to create a continuous screen
Graphite



DFS-25-4 Fence Section 36"W x 31½"H
Hooks and loops link one to another
Set of 4 **Graphite**

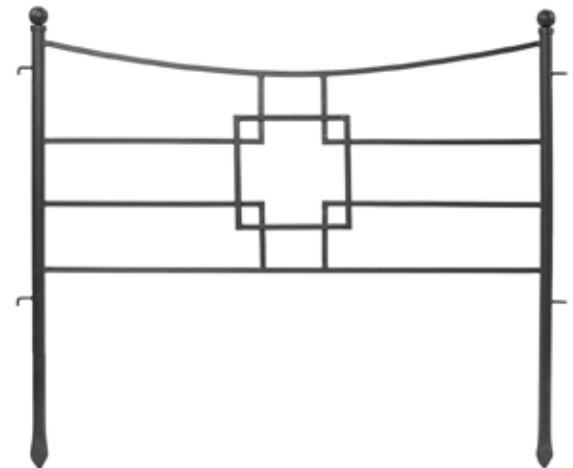



Stakes included with DFS-08-2 fence sections

Fence Sections

Designed as high or low decorative edging along garden borders, these staked sections are easy to reposition as the garden grows and changes.

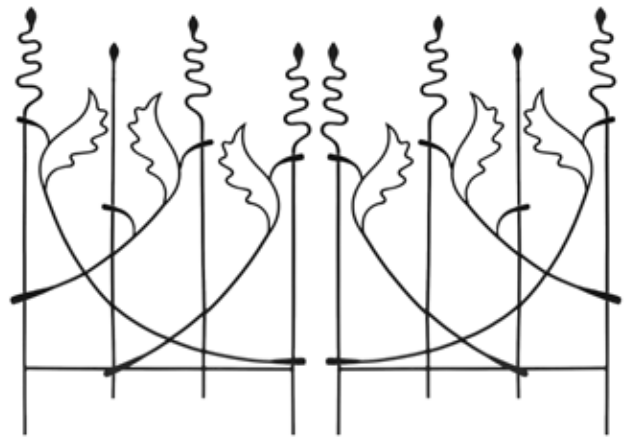

DFS-08-2 Acanthus Fence Trellis
33"W x 47"H; Set of 2
Comes with 4 ground stakes
Black

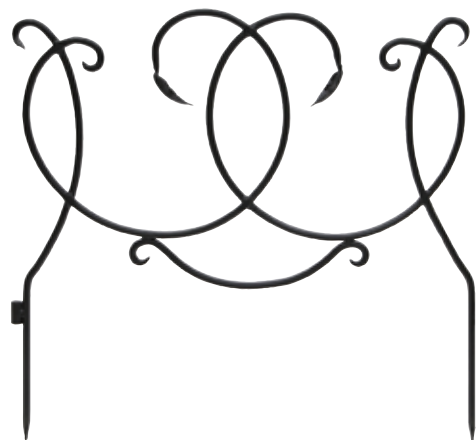

DFS-02-4 Scroll Fence Section
24"W x 22"H; Set of 4 **Black**

Trellises

An architectural element that serves to both accent the garden and support a climbing vine, a sturdy iron trellis will not rot or buckle under the load of a fully grown plant. We offer a wide range of sizes, styles, and shapes, designed to be self-supporting when staked firmly in the ground or anchored to a wall.

Ferro Firenze Roman Bronze
Matches ARB-27 Arbor, pg. 1

FT-27 Trellis I 22"W x 65½"H

FT-28 Trellis II 29"W x 83½"H



FTB-02-2
Wall Brackets
for Trellises
Set of 4; 5¼"L
Black

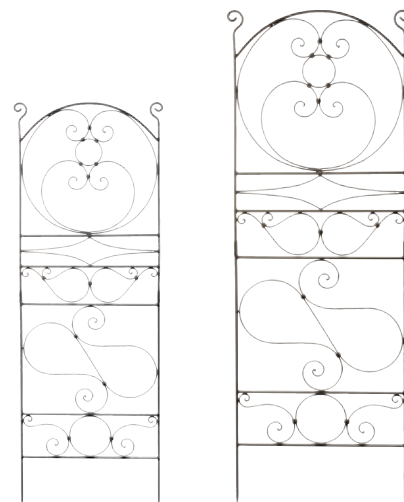
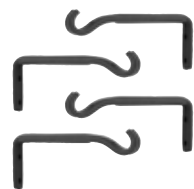

FT-27

FT-28

All wrought iron items have a powder coated finish



VFT-20 Rococo Trellis
36"W x 86"H
Graphite

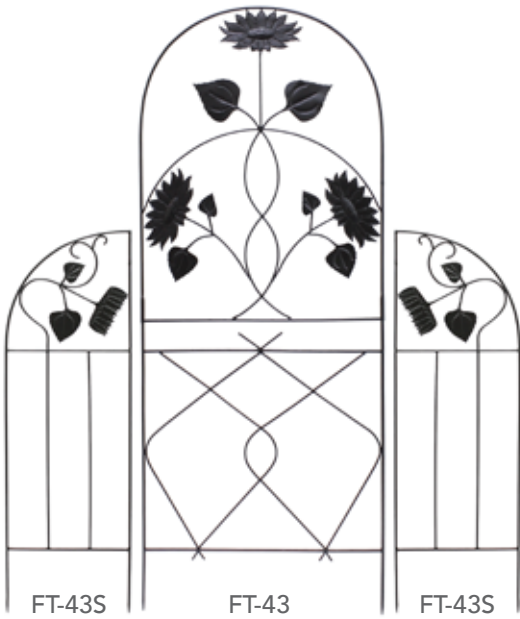
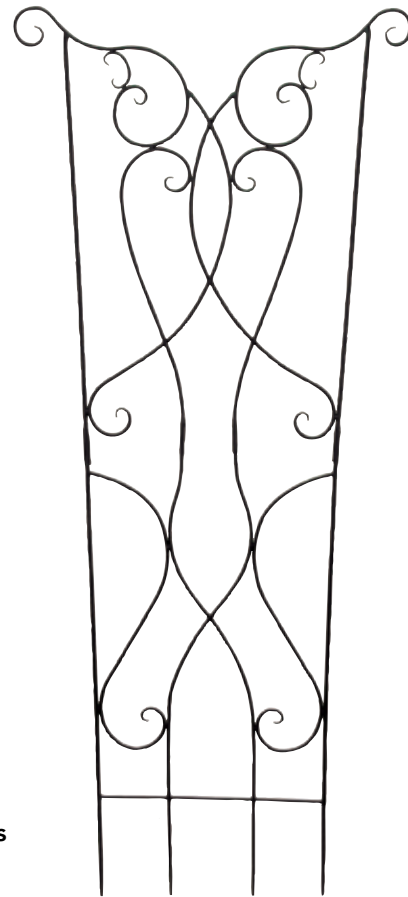

Sunflower Trellises Black

FT-43 Center 36"W x 90"H

FT-43S Side Pair 18¼"W x 58"H



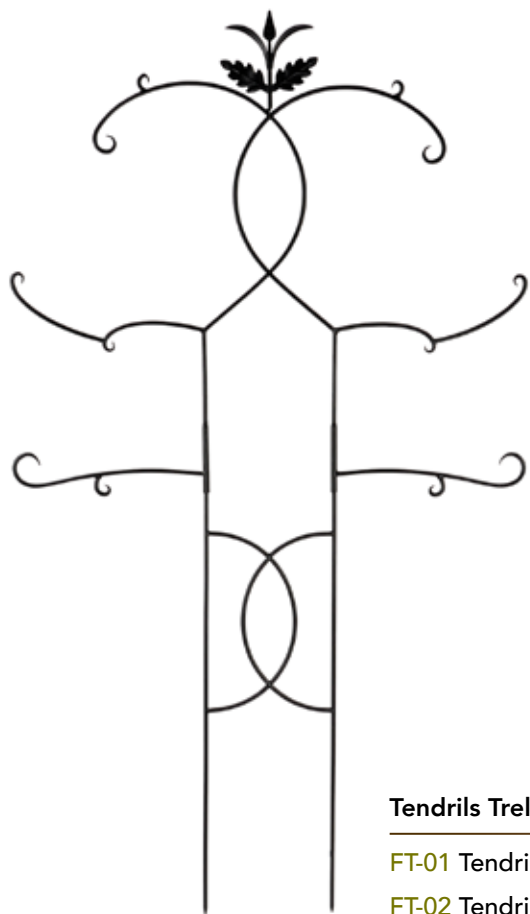

Tendrils Trellises Black

FT-01 Tendrils I 25"W x 79"H

FT-02 Tendrils II 44"W x 79"H



FT-01

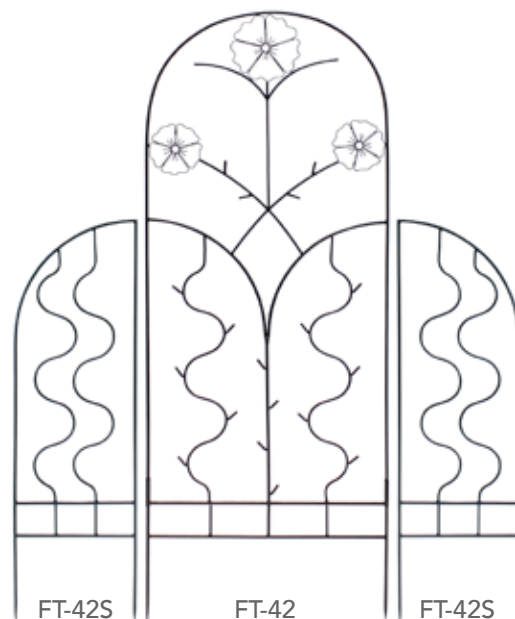

FT-42S

FT-42

FT-42S

Primrose Trellises Black

FT-42 Center 28"W x 72"H

FT-42S Side Pair 14"W x 48"H



FT-46 Athena Trellis 57"W x 8"D x 76"H
Black

Two or more four-foot sections can be mounted at any height to turn a gutter or pole into vertical gardening space. Folds flat for shipping and storage. Mounting loops provided.



FT-47 Downspout Trellis
11½"W x 6¼"D x 92"H
Consists of two sections (46"H ea.) **Black**

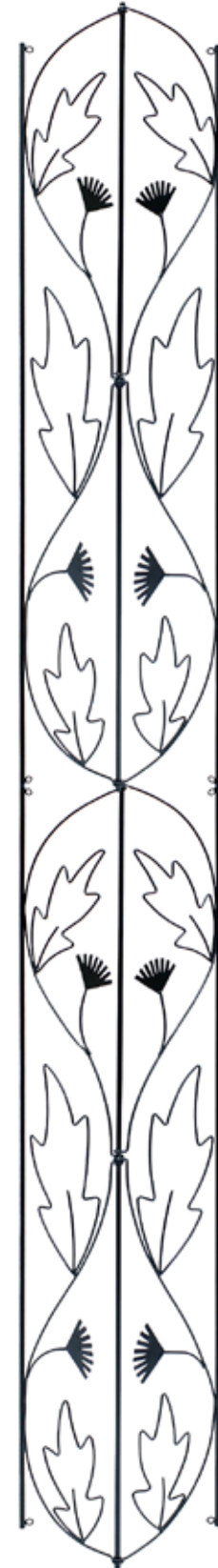

Aldrich Trellises *Graphite*

VFT-22 Aldrich I 31½"W x 75"H

VFT-22S Aldrich II 16½"W x 63"H
Set of 2 can be used independently or with VFT-22 for added width or to form corners

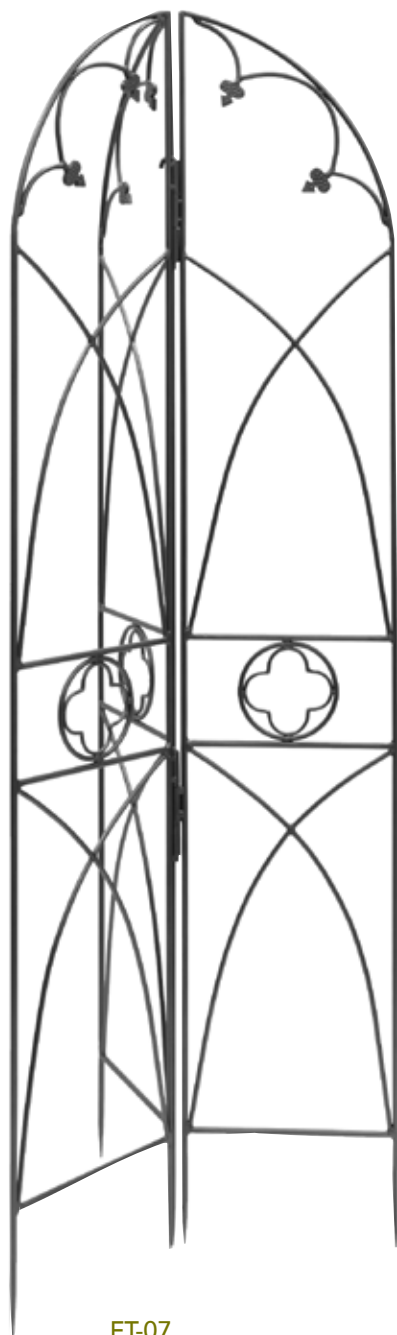

FT-07
Quatrefoil Trellis
Each Panel: 13"W x 75"H
Consists of 3 sections
Opened: 22" - 26"W
Graphite

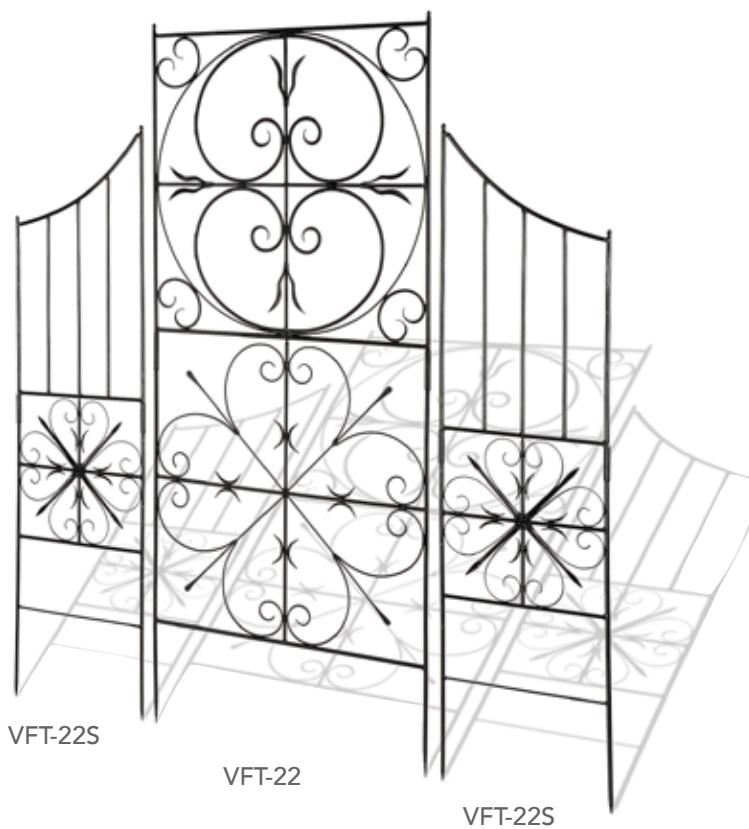

VFT-22S

VFT-22

VFT-22S

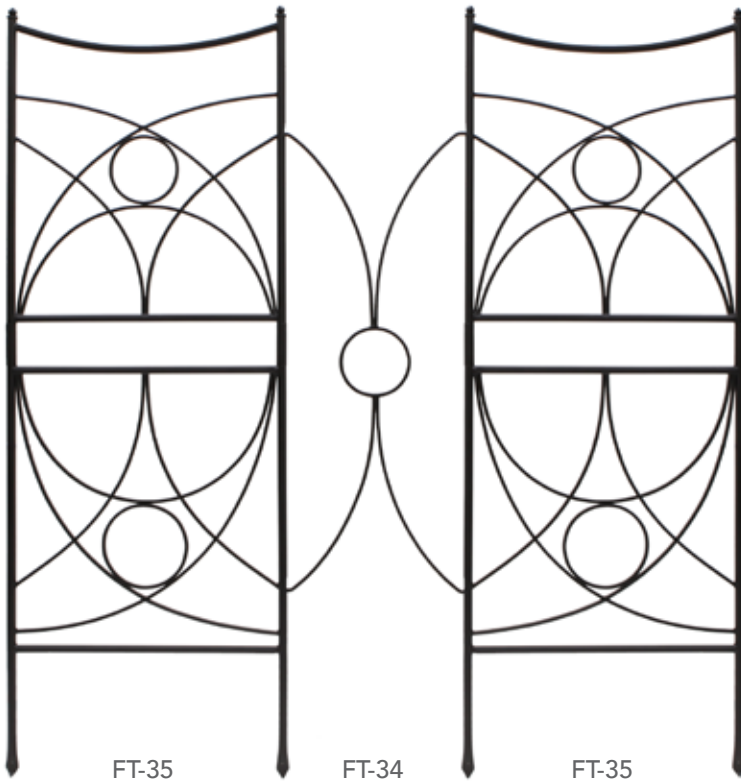

FT-35
Aurora Trellis
 31½"W x 86¼"H
Black

FT-34
Aurora Trellis Center Link
 21¼"W x 52"H
Black

Center link connects two FT-35 trellises

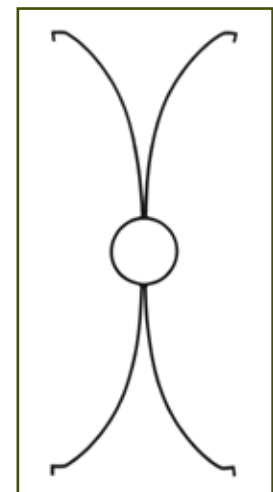

Plant Supports

Our wide array of plant supports include stakes, pylons and trellises for every gardener's need.

For container gardening and single stems, Plant Stakes SFT-04-6, and Spiral FST-01 are smaller in scale and found on [pg. 24](#).

To add vertical elements in the landscape, Mushroom Trellis PYL-09, and Lattice Obelisk, OBL-25 lift vining vegetables and showy flowers, all on [pgs. 22 - 23](#).

For green screening, use freestanding or wall-mounted modular trellises, Oxfordshire Trellis FT-54 [pg. 21](#), Square-on-Squares [pgs. 6 - 9](#) or our Vinifera trellis FT-48 [pg. 19](#).



FT-66
Ovals Trellis
30½"W x 60¾"H
Black



FT-62
Gingerbread Cottage Trellis
18"W x 72"H
Black

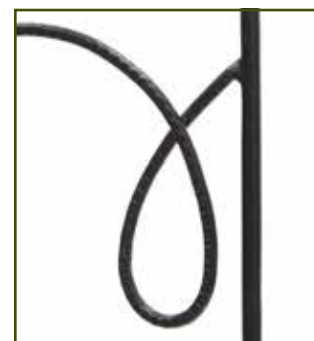

FT-62 Hammered Detail

All wrought iron items have a powder coated finish



Lantern not included

FT-58 Samsara Trellis
24¾"W x 1¼"D x 79¾"H
Black

Matches our Samsara arbor, ARB-58 on [pg. 3](#)

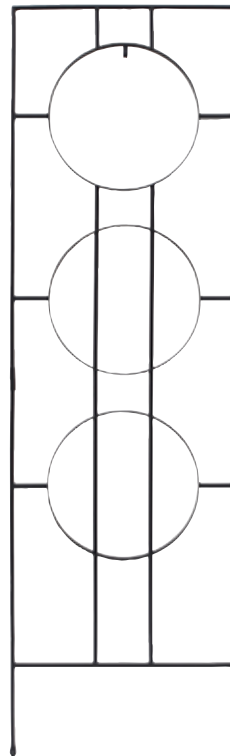

Our contemporary trellis designs are bold and geometric, with space to add color and light, for garden interest.

FTB-02-2
Wall Brackets for Trellises
Set of 4; 5¼"L
Black

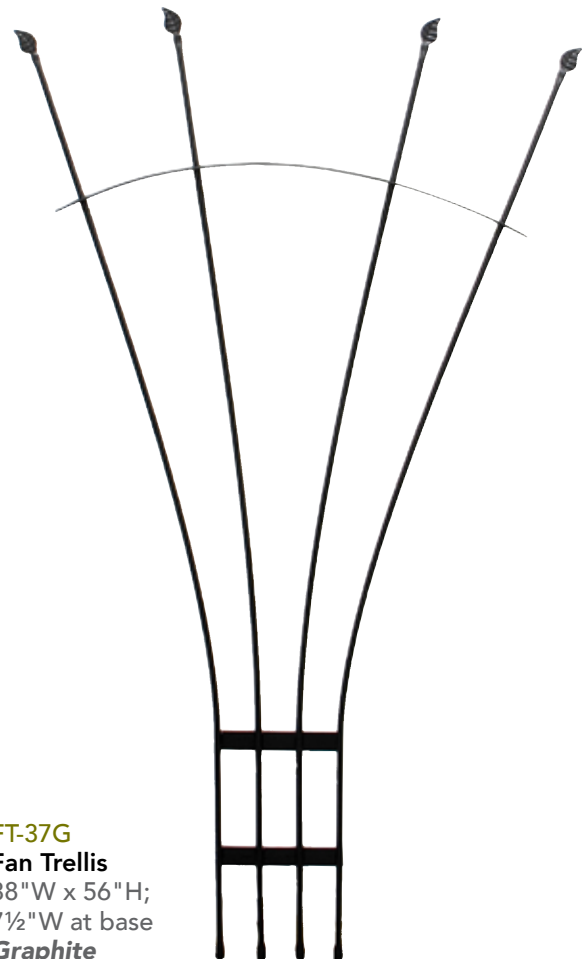

FT-37G
Fan Trellis
38"W x 56"H;
7½"W at base
Graphite

Waves Trellis
 Three parts with extension option
Black

FT-16 Trellis
 23½" W x 77" H

FT-16E Extension
 23½" W x 24" H

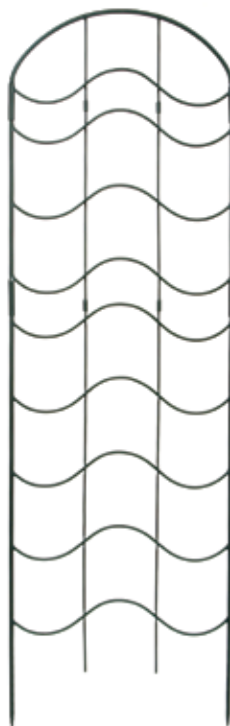
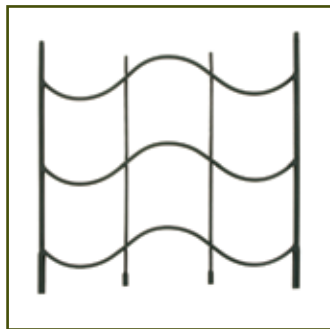

Bottles not included

Contemporary design meets classic vintage in the Vinifera Bottle Trellis, with space for six colorful glass bottles of your own choosing. Most of our trellises are rigid enough to be set as free-standing design elements. Plant with blooming vines for a multi-textural outdoor screen or divider.



Cork stoppers secure bottles in place.

FT-48 Vinifera Bottle Trellis
 24¾" W x 79¾" H
Black

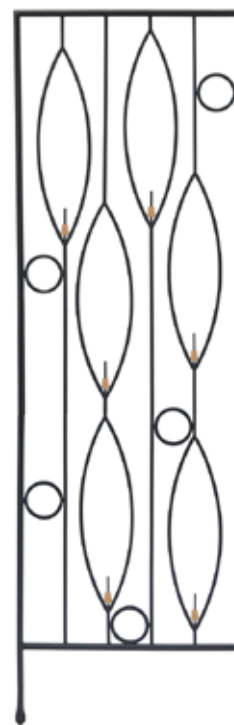

Cottage Collection Trellises

Evoke the climbing roses and brambles of a lush English country garden. These airy trellises are ideal components for contemporary and traditional garden designs.



FT-30 Freestanding Lattice Trellis
33"W x 8"D x 84"H; Folds **Graphite**

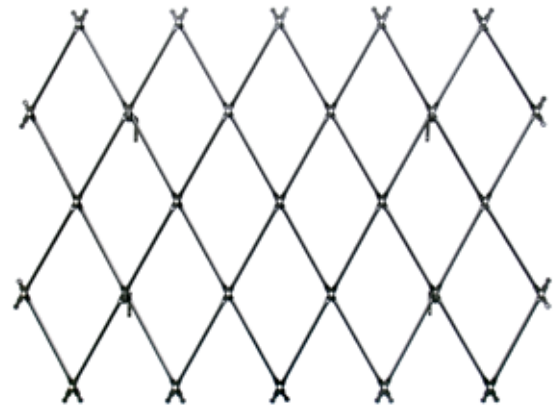
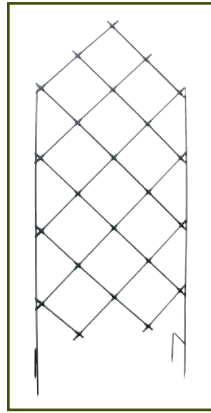

FT-32G Wall Mounted Lattice Trellis
46"H max;
Can be expanded or contracted as desired
Preferred dimensions: 36"H x 68"W
Wall brackets included **Graphite**

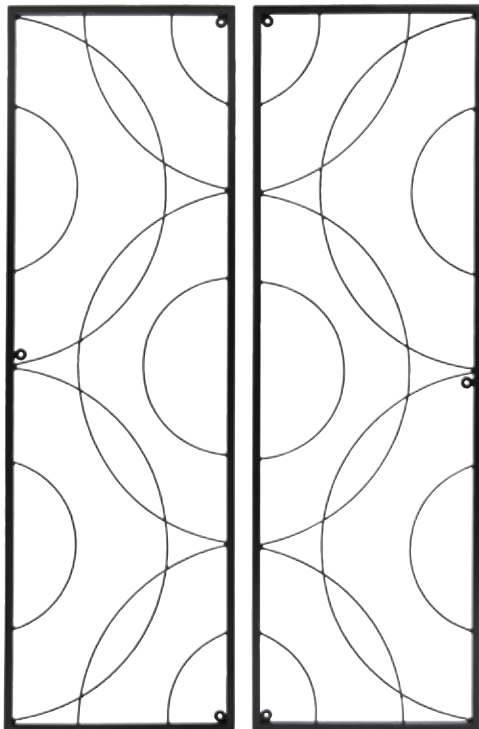

FT-55 Corona Trellis
Each panel: 13¼"W x ½"D x 42"H
Spacers included **Black**



Hang horizontally or vertically,
combine multiple sets in a variety of arrangements

All wrought iron items have a powder coated finish



FT-54

Oxfordshire Trellis
Spacers included **Black**

FT-54 Two Pieces
46"W x 1/2"D x 42"H
Arc: 35"W x 19"H

FT-54E Single Trellis Extension
for FT-54 or FT-56
46"W x 1/2"D x 23"H

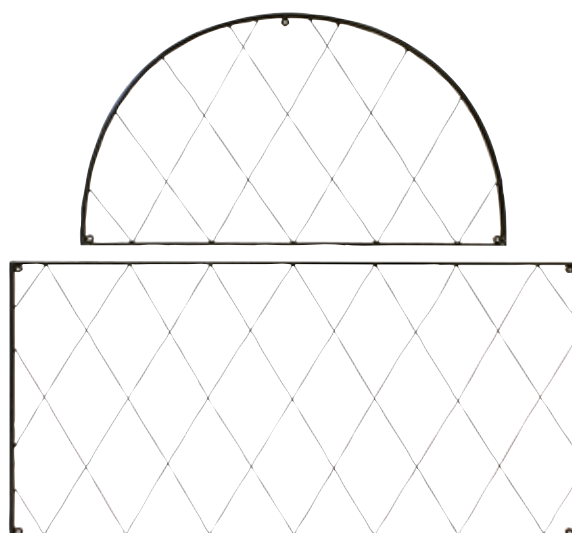
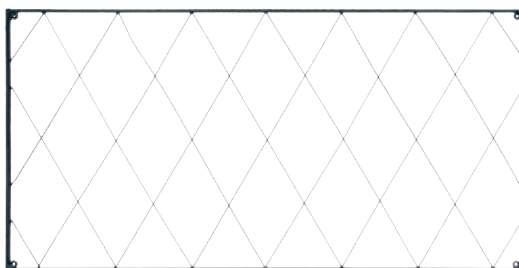

These airy trellises are designed as modular units to anchor plants to the wall. Sold in two-piece sections, with extensions available.

FTB-05-2
Wall Brackets for Trellises
Set of 4; 3 3/8"L
Black

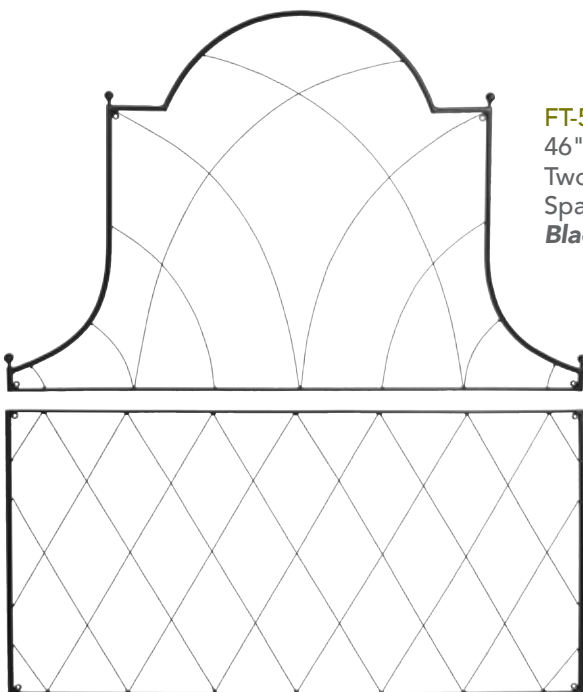

FT-56 Somerset Trellis
46"W x 1/2"D x 53"H
Two pieces
Spacers included
Black



FT-56 with FT-54E

NEW

Vertical Elements

A tall visual anchor in the landscape can bring blooms to eye-level and edibles up for easy picking. Frame a path, draw visitors to a focal point, or create a "tree" of blossoms to surround with a seating area.



NEW **PYL-21 Minar Pylon I**
65½" H x 17¾" sq. base
Graphite

OBL-25 Lattice Obelisk
67" H x 20" square base
Shipped flat; Assembly required
Graphite



PYP-01 Multi Purpose Anchoring Pins
10" L Set of 4 pins
Graphite

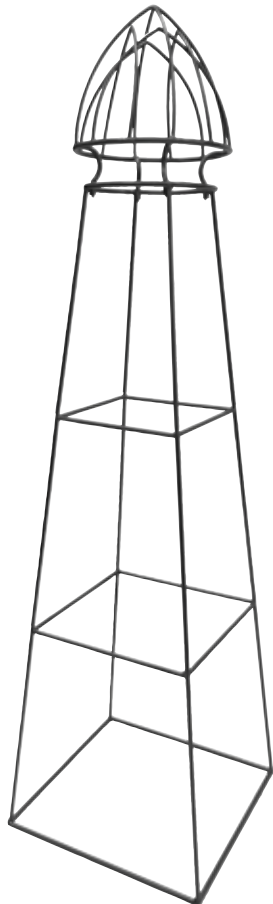

All wrought iron items have a powder coated finish

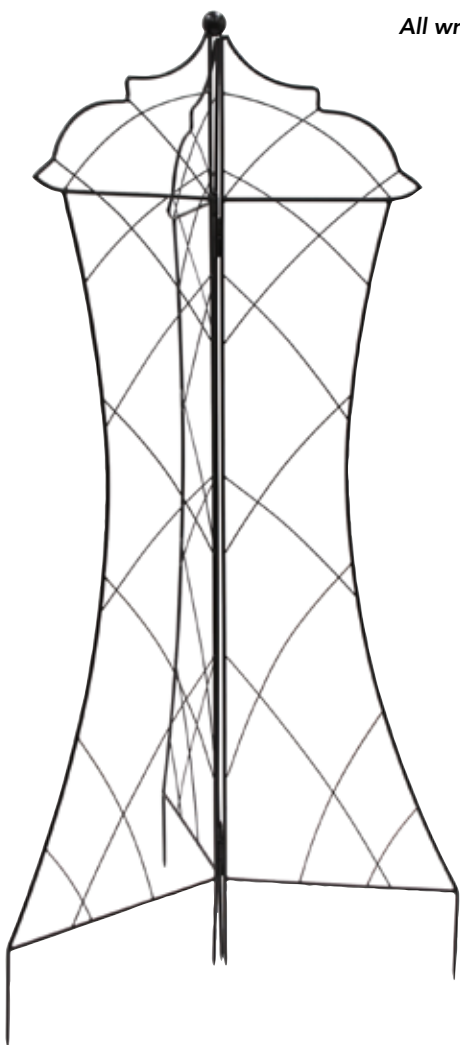

FT-59 Chess Queen Trellis
 Each panel: 20"W x 79½"H
 Consists of 3 sections
 Opened: 35" - 41"W
Black

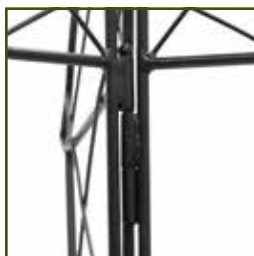

Bases can be anchored with PYP-01 anchoring pins or weighed down with rocks.

PYL-09 Mushroom Trellis
 36" dia. x 72"H **Roman Bronze**

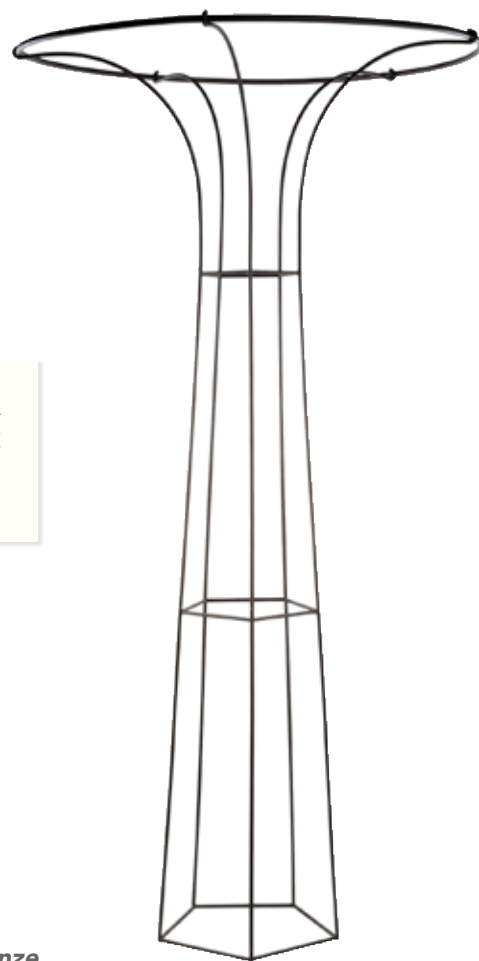



FST-01 Spiral Trellis
8" dia. x 42" H **Black**



SFT-04-6 Plant Stake
3¼" dia. x 41" H
Set of 6 **Black**



FT-20

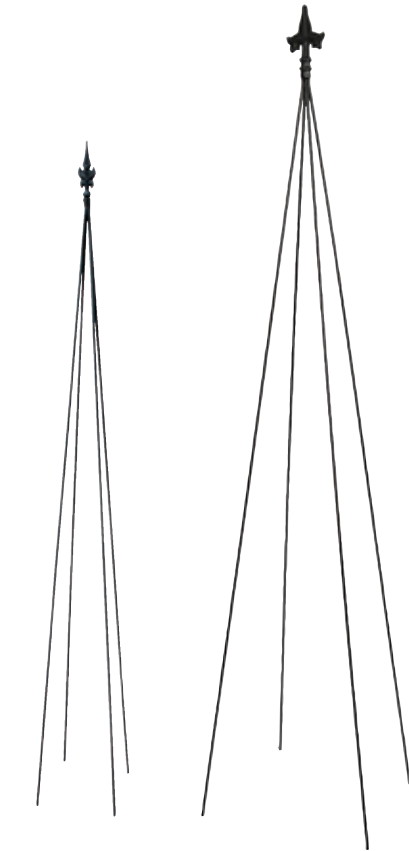

Fleur-de-Lis Trellises Black
Legs can be pulled apart before staking for desired footprint

FT-20 58" H **FT-21 78" H**

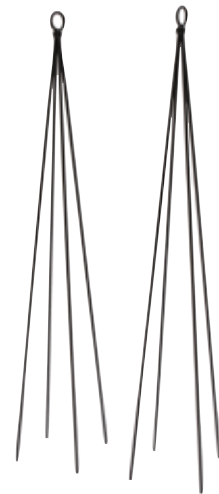

FT-22-2 Container Trellis
Shipped flat; 34" H Set of 2
Legs can be pulled apart before staking for desired footprint **Black**



FT-61 Butterfly Trellis
42"W x 1"D x 49¾"H
Graphite

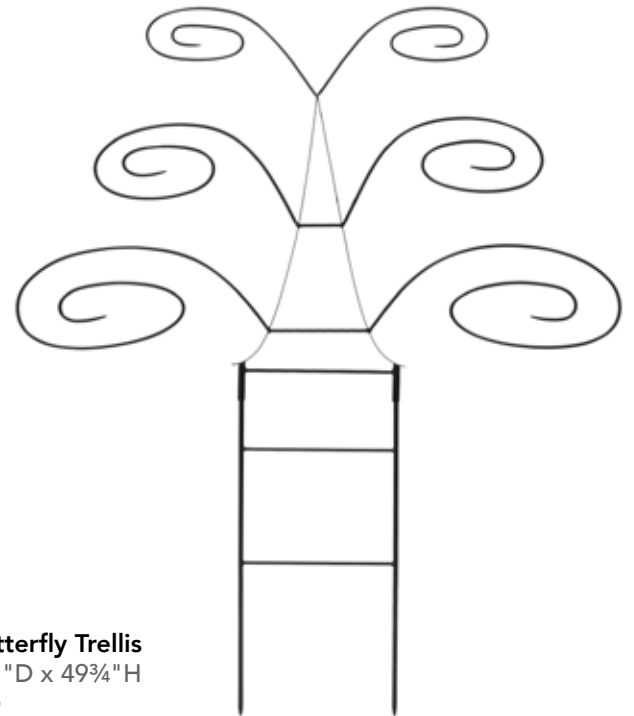

Obelisks
Shipped flat;
assembly required
Graphite

OBL-01 3 Rings
9½" dia. x 61½"H
Base: 10"W x 10"D

OBL-02 4 Rings
13" dia. x 85"H
Base: 13½"W x 13½"D



All wrought iron items have a powder coated finish



FT-60 Zigzag Screen Trellis

Each panel: 26½"W x 84"H

Total width: 79½"W

Consists of 3 sections **Black**

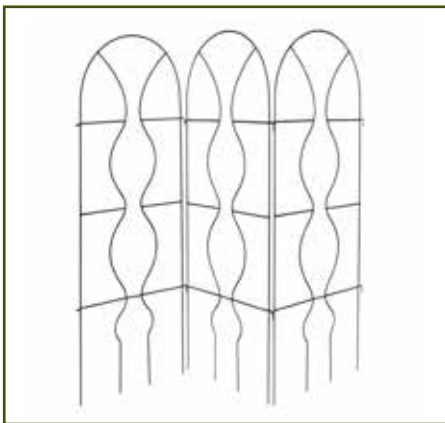
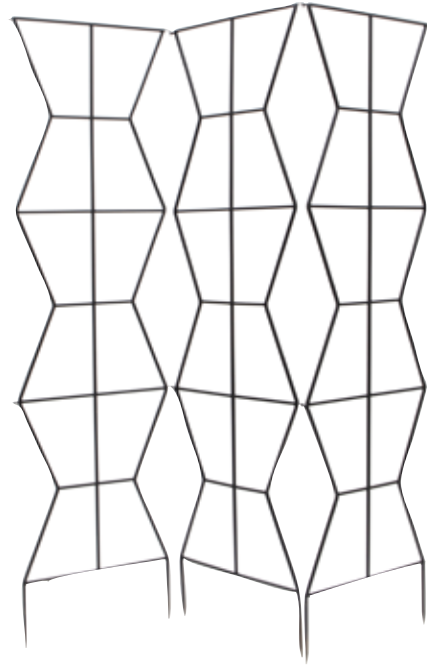

Link three individual FT-11 Trellises together to form a free-standing screen

FT-11
Orangery Trellis
24"W x 65"H
Black

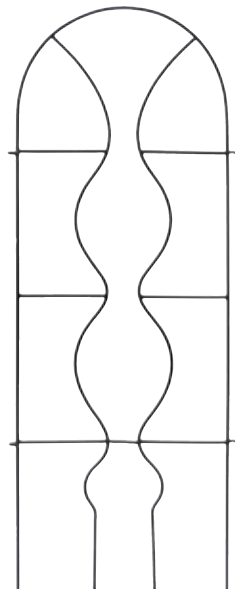

Plant Stands

Present a single show-stopper or create a stylish grouping for an indoor living space or outdoor room. Our wrought iron plant stands come in sizes and styles for every decor.

The Scandinavian Design Inspired Arne Stands are sleek, minimalist and versatile. In two stand heights with three top options; they become accent tables, container gardens, or plant stands.



Arne Stands Sold in six combinations **Black**
 Short stand: 15"sq. x 14"H Tall stand: 15"sq. x 22¼"H

Copper tray 1½"D x 15"sq.

FB-45C Short stand

FB-46C Tall stand

Galvanized tray 3"D x 15"sq.

FB-45G3 Short stand

FB-46G3 Tall stand

Deep Galvanized tray 7"D x 15¾"sq.

FB-45G7 Short stand

FB-46G7 Tall stand





VPS-04 Verandah Stand
 13¼" dia. x 40½"H
 Basket accepts a 12" flowerpot
Graphite



FB-19



FB-20

Tulip Stands Roman Bronze

FB-19 Stand
 15" dia. x 28½"H

FB-20 Stand
 15" dia. x 28½"H
 Removable top insert



Trivet Stands Graphite

VTT-01 Round
 11½" dia. x 14"H

VTT-02 Triangular
 12¼"W sides x 12"H





FC-01 Herb Caddy
Caddy: 22¼" L x 9¼" W x 16" H
Includes cobalt blue glass pots,
each 5" dia. at top; 5" H
Black



FB-18

Ring Stands Black

FB-14 Ring Stand
11" dia x 14" H

FB-18 Ring Stand
13" dia x 18" H



FB-14



GT-03 Tray with CWI-04

Folding Stands Black

For use with tubs, flower boxes, and trays

CWI-01 Tabletop
7¼" H x 12" sq. opened
16¾" L x 2¾" D closed
Shelf: 14" L x 1" D

CWI-04 Short Floor
19½" H x 15" sq. opened
20½" L x 2¾" D closed
Shelf: 18" L x 2" D

CWI-02 Floor
23" H x 13" sq. opened
17½" L x 2¾" D closed
Shelf: 15¼" L x 1¼" D

CWI-03 Large Floor
29½" H x 14¾" sq. opened
20¼" L x 2¾" D closed
Shelf: 18" L x 2" D

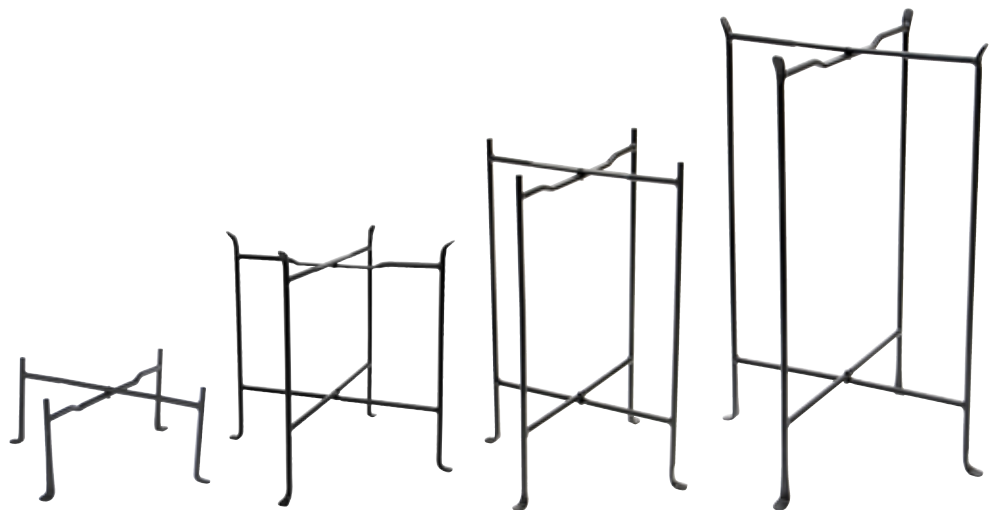

All wrought iron items have a powder coated finish



NEW Frida Plant Stands *Black*

FC-06 Frida I
 10½" dia. x 6¼" H
 5¾" D; 7¼" W at feet

FC-07 Frida III
 4⅝" dia. cups
 7⅝" H x 7½" W at feet

FC-08 Frida IV
 5½" dia. cups
 11⅞" H x 7½" sq. at feet



Pair with TRY-07-4 Scalloped Rim Trays

FC-05 Cascading Plant Stand
 14"W x 17¾" H; 4 rings each 5¼" dia.
 placed at varying heights of 6", 10",
 14" and 17¾" **Graphite**

Showcase a prize collection of succulents or violets with these smaller stands designed for multiple small pots. Scalloped Rim Recycled Glass Trays fit both FC-05 and FC-08 stands.



FC-08 with TRY-07-4 Tray



TRY-07-4 Scalloped Rim Recycled Glass Tray
 5¾" dia. x ¾" D
 Set of 4



Piazza Plant Stands Black

GBS-23 10" Stand
 12¼"W x 4¼"H;
 10¼" dia. top

GBS-24 14" Stand
 16"W x 6"H;
 14" dia. top



Short Stands Black

Can be used as a flower pot or birdbath stand

GBS-22 Short Stand
 10"W x 10"D x 6"H
 Ring: 9½" dia. **Black**

GBS-25 Short Stand II
 14¾"W x 14¾"D x 6"H
 Ring: 13¾" dia. **Black**



Patio Flowerpot Stands Black

FB-03 18" Stand
 11¼" dia. x 17½"H
 12"sq. at feet

FB-02 12" Stand
 11¼" dia. x 12"H
 12"sq. at feet

FB-01 7½" Stand
 10" dia. x 7¾"H
 12"sq. at feet

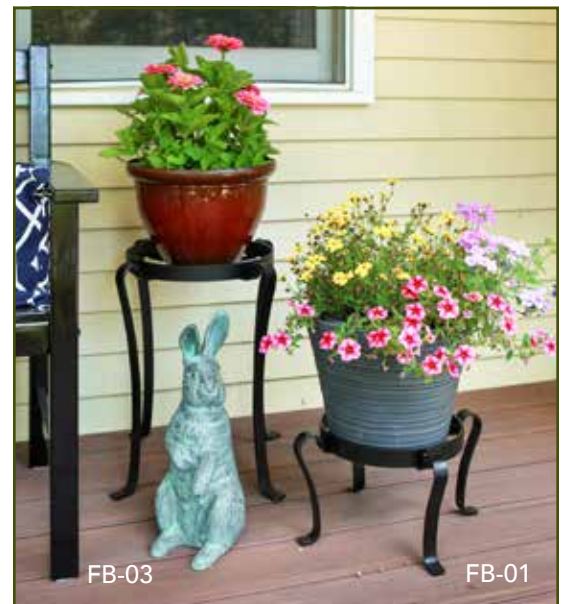

All wrought iron items have a powder coated finish



Argyle Stands *Graphite*

FB-30 8" Stand
12" dia. at top: 8"H
15" dia. at feet

FB-31 14" Stand
10½" dia. at top: 14"H
15" dia. at feet

FB-32 18" Stand
10¼" dia. at top: 18"H
13" dia. at feet

FB-33 24" Stand
11½" dia. at top: 24"H
15" dia. at feet



Tara Plant Stands *Roman Bronze*

FB-81 15" Stand
15½"H x 10½" dia.
10"sq. at feet

FB-82 18" Stand
18¾"H x 10½" dia.
10"sq. at feet

FB-83 24" Stand
24½"H x 11½" dia.
11¼"sq. at feet

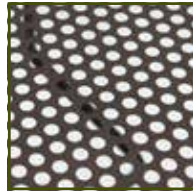

5/16" Perforated Top



Capri Plant Stands Roman Bronze

FB-35 12" Stand
12" dia. top: 12½"H
10"sq. at feet

FB-36 18" Stand
16" dia. top: 18½"H
14"sq. at feet

FB-37 24" Stand
14" dia. top: 24¾"H
12"sq. at feet



FB-21



Flowers Stands Roman Bronze

FB-21 12" Stand
9¼" dia. x 12"H
9"sq. at feet

FB-22 16" Stand
11¾" dia. x 16"H
11½"sq. at feet

FB-23 25" Stand
14¾" dia. x 25"H
14½"sq. at feet



FB-76 Catalina Plant Stand
 13¾"L x 13¾"W x 23½"H
 Top Platform: 13¾" dia.
 Base Dim: 10¼"sq. **Black**



FB-66 Duet Plant Stand
 26"L x 12½"W x 30½"H
 Top Platform: 24"H from ground
 10"L x 12"W
 Bottom Platform: 14"H from ground
 18"L x 12"W
Black

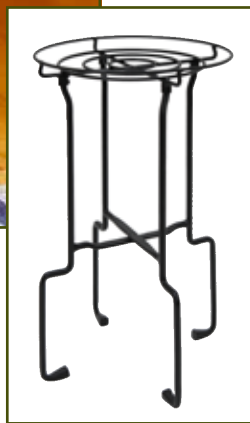

Our Nesting Tables, in three sizes, can be used separately as side tables or plant stands. Tuck them neatly away, under one another, to save space.

WTN-01 Triangular Nesting Tables
 Set of 3
 Small: 15¾"W sides x 16"H
 Medium: 19½"W sides x 19¾"H
 Large: 23½"W sides x 23½"H
Roman Bronze





FBC-17-61FB Kazuyo Planter
 20" dia. x 33"H
 Bowl Dim: 20" dia. x 10"D
 Stand Height: 24¼"
 Base Dim: 11"L x 11½"W
**Polished Stainless Steel,
 French Blue powder coat**



FB-65 Julia Plant Stand
 16"W x 16"D x 16"H
Black



FB-72



FB-71

Ibex Plant Stands
Black

FB-71 Ibex I
 10½"W x 12"H

FB-72 Ibex II
 14"W x 18"H



FB-71

SOLARIA COLLECTION

Our mother-daughter design team has created this exclusive collection of planters for a bold style statement in green living. Be it modern or bungalow, indoor or outdoor living space, the Solaria Collection offers endless creative possibilities for your plant scapes. Drawing on our backgrounds, as fine artist and architect, these pieces pay tribute to talented women designers and architects of past and present.

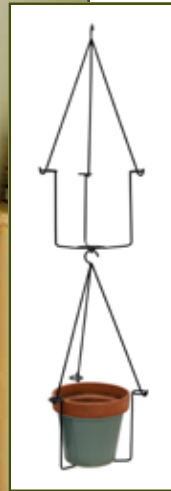

VERA Hanging Planters Slip-in components
Black, French Blue powder coat and Burnt Sienna patina

BH-03-62FB
10½"W x 10½"D x 22½"H
Pot: 8" dia. x 7¼"H
with **French Blue Pot**

BH-03-2 Hanger Only
10½"W x 10½"D x 22½"H
Fits a standard 8" clay pot
Set of 2 **Black**

BH-03-62BS
10½"W x 10½"D x 22½"H
Pot: 8" dia. x 7¼"H
with **Burnt Sienna Pot**

LINA Hanging Planters
Slip-in components
Black, Burnt Sienna patina

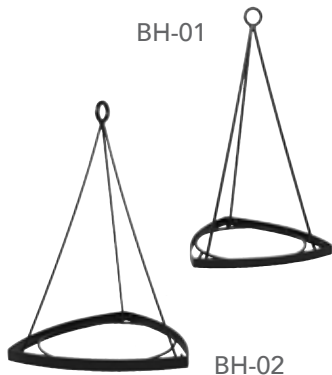

BH-01-63BS
10½"W x 10½"D x 22¼"H
Ring: 7¾" inside dia.
Pot: 8" dia. x 5¾"H
with **Burnt Sienna Pot**

BH-01 Hanger Only
10½"W x 10¼"D x 18¼"H
Ring: 7¾" inside dia.
Black

C-63BS Pot Only
8" dia. x 5¾"H
Burnt Sienna patina

BH-02-64BS
15½"W x 15"D x 28"H
Ring: 11½" inside dia.
Pot: 12" dia. x 8¼"H
with **Burnt Sienna Pot**

BH-02 Hanger Only
15½"W x 15"D x 21¼"H
Ring: 11½" inside dia.
Black

C-64BS Pot Only
12" dia. x 8¼"H
Burnt Sienna patina



FBC-64-62FB

FB-64 EILEEN Plant Stand
7"W x 7"D x 9¾"H
Black



EILEEN Planters
with French Blue or Burnt Sienna Pots
Black, Powder coat, Patina

FBC-64-62FB
7"W x 7"D x 15¼"H
Pot: 8" dia. x 7¼"H
Black, French Blue

FBC-64-62BS
7"W x 7"D x 15¼"H
Pot: 8" dia. x 7¼"H
Black, Burnt Sienna

C-62FB Pot Only
8" dia. x 7¼"H
French Blue

C-62BS Pot Only
8" dia. x 7¼"H
Burnt Sienna patina



FLORENCE Planters
with French Blue or Burnt Sienna Pots
Stands fold flat for easy storage and shipping
Black, Powder coat, Patina

FBC-63-62FB
9¼"W x 9¼"D x 15¼"H
Pot: 8" dia. x 7¼"H
Black, French Blue

FBC-63-62BS
9¼"W x 9¼"D x 15¼"H
Pot: 8" dia. x 7¼"H
Black, Burnt Sienna



FBC-63-62BS

FB-63 FLORENCE Plant Stand
9¼"W x 9¼"D x 9"H
Stand folds flat for storage
Black

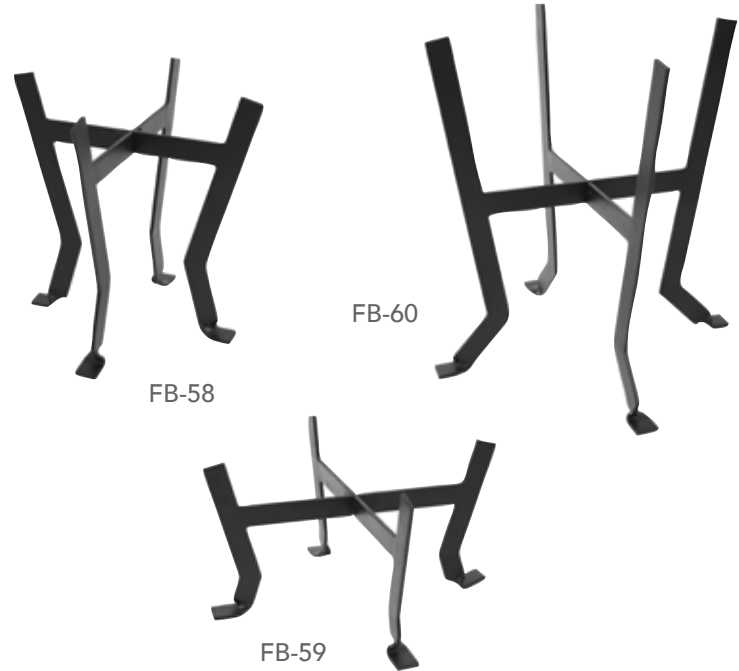

DENISE Planters
Black, Terra Cotta finish poly-stone pot

FB-58-S DENISE II
 13½"W x 13½"D x 17½"H
 Pot: 12¼" dia. x 6"H

FB-58 Stand Only
 13½"W x 13½"D x 14"H
 Shelf from top: 9½"L x 3"D
 Base: 9"sq.

FB-59-S DENISE I
 16½"W x 16½"D x 14¾"H
 Pot: 16" dia. x 7¼"H

FB-59 Stand Only
 16½"L x 16½"D x 9"H
 Shelf from top: 12½"L x 2½"D
 Base: 12"sq.

FB-60 DENISE III
Stand Only
 16½"W x 16½"D x 18"H
 Shelf from top: 11"L x 8"D
 Base: 12½"sq.



ODILE Planter with Copper Flower Box

FBC-62-10C
 Slip-in components
 27½"W x 9"D x 18¼"H
 Box: 22"W x 9"D x 12"H
Black, Copper Plated

C-10C Flower Box Only
 22"W x 9"D x 12"H
Copper Plated

C-10C

Solaria tapered pots are made from galvanized steel with Copper Plated finish



MARION Planters with Copper Flower Boxes
Black, Copper Plated

FBC-50-11C MARION I
12½"W x 12½"D x 14¼"H
Pot: 12½"sq. x 6½"H

FBC-51-12C MARION II
16¼"W x 16¼"D x 23"H
Pot: 16¼"sq. x 13¼"H

C-11C Planter Box Only
12½"sq. x 6½"H

C-12C Planter Box Only
16¼"sq. x 13¼"H



ZAHA Planters with Copper Flower Boxes
Black, Copper Plated Slip-in components

FBC-55-12C ZAHA II
16¼"W x 16¼"D x 22¼"H
Pot: 16¼"sq. x 13¼"H

FBC-54-11C ZAHA I
12½"W x 12½"D x 13"H
Pot: 12½"sq. x 6½"H

FB-55 Stand Only
11"W x 11"D x 10"H

FB-54 Stand Only
8¼"W x 8¼"D x 7"H

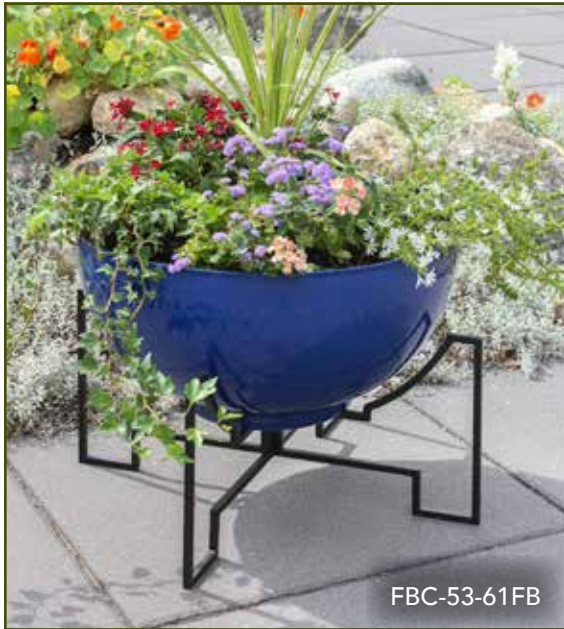

FBC-53-61FB



JANE Planters with French Blue Bowls
Black, French Blue powder coat Slip-in components

FBC-52-60FB JANE I
16"W x 16"D x 13¼"H
Pot: 16" dia. x 8"H

FBC-53-61FB JANE II
20"W x 20"D x 15¼"H
Pot: 20" dia. x 10"H

JANE Planters with Burnt Sienna Bowls
Black, Burnt Sienna patina
Slip-in components

FBC-52-60BS JANE I
16"W x 16"D x 13¼"H
Pot: 16" dia. x 8"H

FBC-53-61BS JANE II
20"W x 20"D x 15¼"H
Pot: 20" dia. x 10"H

FB-52 Stand Only
13½"W x 13½"D x 9"H

FB-53 Stand Only
16"W x 16"D x 10"H





NORMA Planters with Burnt Sienna Bowls
Black, Burnt Sienna patina Slip-in components

FBC-57-61BS NORMA II
 20"W x 20"D x 18"H
 Pot: 20" dia. x 10"H

FBC-56-60BS NORMA I
 16"W x 16"D x 13¾"H
 Pot: 16" dia. x 8"H

C-61BS Bowl Only
 20" dia. x 10"H

C-60BS Bowl Only
 16" dia. x 8"H



NORMA Planters with French Blue Bowls
Black, French Blue powder coat Slip-in components

FBC-57-61FB NORMA II
 20"W x 20"D x 18"H
 Pot: 20" dia. x 10"H

FBC-56-60FB NORMA I
 16"W x 16"D x 13¾"H
 Pot: 16" dia. x 8"H

C-61FB Bowl Only
 20" dia. x 10"H

C-60FB Bowl Only
 16" dia. x 8"H



C-60BS



C-10C Copper Plated Flower Box
Stand shown on [pg. 38](#)
22"W x 9"D x 12"H
Satin finish

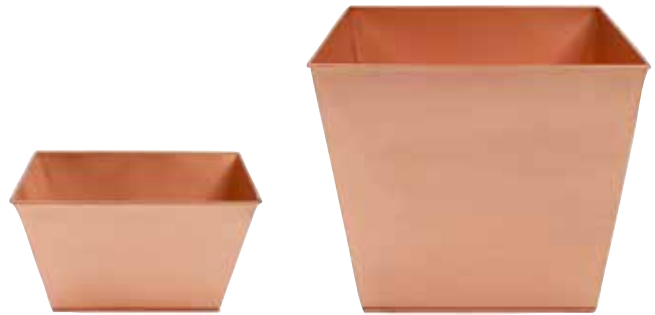

Copper Plated Tapered Planters
Stands shown on [pg. 39](#) *Satin finish*

C-11C Small
12½"sq. x 6½"H

C-12C Large
16¼"sq. x 13¼"H



C-61FB

C-60FB



C-61BS

C-60BS

Steel Planting Bowls Stands shown on [pgs. 40-41, 35](#)
Burnt Sienna patina & French Blue powder coat finish

C-60BS Small
Burnt Sienna Bowl
16" dia. x 8"H

C-60FB Small
French Blue Bowl
16" dia. x 8"H

C-61BS Large
Burnt Sienna Bowl
20" dia. x 10"H

C-61FB Large
French Blue Bowl
20" dia. x 10"H

Steel Planting Pots
Hangers shown on [pg. 36](#)
Burnt Sienna patina

C-63BS Small
8" dia. x 5¾"H

C-64BS Large
12" dia. x 8¼"H



C-64BS



C-63BS

Steel Cylinder Planting Pots
Stands shown on [pg. 36-37](#)

C-62BS Burnt Sienna Pot
8" dia. 7¼"H

C-62FB French Blue Pot
8" dia. x 7¼"H



C-62BS



C-62FB

These versatile tubs are watertight and should be drilled for direct planting



C-51-S1
Oval Galvanized Tub with Folding Stand
 24"L x 15"W x 15¾"H
 Tub: 24"L x 15"W x 9¾"H with handles
 Stand: 7"H; folds to 18"W x 1"D
Black, Galvanized Steel



C-51M-S1
Mini Oval Galvanized Tub with Folding Stand
 16¾"L x 10½"W x 13¼"H
 Tub: 16¾"L x 10½"W x 7¼"H
 Stand: 7"H; folds to 18"W x 1"D
Black, Galvanized Steel



C-81C-S1
Oval Copper Tub with Folding Stand
 24"L x 15"W x 15¾"H
 Tub: 24"L x 15"W x 9¾"H with handles
 Stand: 7"H; folds to 18"W x 1"D
Black, Copper Plated



C-52-S1
Embossed Oval Tub with Folding Stand
 20"L x 13¼"W x 12"H
 Tub: 20"L x 13¼"W x 6½"H
 Stand: 7"H; folds to 18"W x 1"D
Black, Galvanized Steel



C-09C-S1
Copper Flower Box with Folding Stand
 23½"L x 7¾"W x 13¼"H
 Box: 23¼"L x 7¾"W x 7½"H
 Stand: 7"H; folds to 18"W x 1"D
Black, Copper Plated

Galvanized Tubs

These classic steel tubs are ubiquitous on every farm because they have a thousand and one uses. Directly plant flowers and veggies for a container garden, use for firewood storage, or chill drinks at a summer party. In many sizes and styles that fit in stands for both floor and tabletop use.

C-55C Oval Tub with CWI-04 Folding Stand, see pg. 29



C-50C Round Tub with CWI-01 Folding Stand, see pg. 29



Hammered Copper Plated

C-55C Oval 27" L x 15¼" W x 11½" H (31¼" L at handles)

C-50C Round 16½" dia. x 10¼" H (19" W at handles)



C-51M



C-50



C-51M

Galvanized Steel

C-50 Round 16¼" dia. x 10¼" H (19¼" W at handles)

C-51M Small Oval 16½" L x 10¾" W x 7¼" H

C-51 Oval 21" L x 15" W x 9" H (24" L at handles)

C-55 Large Oval 26¼" L x 16¾" W x 11¼" H (29½" L at handles)



C-51



C-55



C-51BK Oval Black
21"L x 15"W x 9"H
(24"L at handles)
Galvanized Steel, Black



C-81C
Oval Copper Plated
21"L x 15"W x 9"H
(24"L at handles)



Embossed 20"L x 13"W x 6½"H

C-52 Galvanized

C-52C Copper Plated



C-52



WI-08



WI-09

Steel Harvest Baskets

Handwoven steel wire with solid steel bottoms and sturdy handles; great as log holders **Black**

WI-08 Small 23¼"L x 14½"W x 12¾"H

WI-09 Large 25¾"L x 22"W x 12½"H

Benches

Benches have come a long way, evolving from simple split log, to ornate and fanciful ironwork. They have become their own category of garden feature, implicit to shared seating and dining, a place for conversation, for quiet contemplation, and garden enjoyment.



OFB-08-P 4' Backless Bench
48"W x 15¾"D x 17"H *Natural Oil finish*



Eucalyptus furniture in Natural finish has been treated with Linseed Oil. Periodic reapplication is recommended to ensure longevity.





OFB-10W-P Fretwork Bench
48"W x 20"D x 35"H
Seat height: 16¾"H; Arm height: 25"H
White



We recommend bringing furniture inside or covering it with a waterproof tarp during extreme weather months.



OFB-CVR Bench Cover
Fits 4-foot benches; 52"W x 36"D x 38"H
Heavyweight polyester with PVC lining



OFB-10B-P Fretwork Bench
48"W x 20"D x 35"H
Seat height: 16¾"H; Arm height: 25"H
Black



All wrought iron items have a powder coated finish

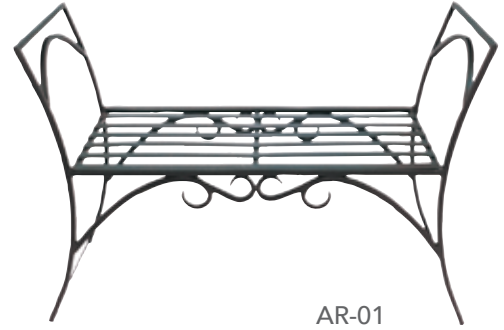

AR-01

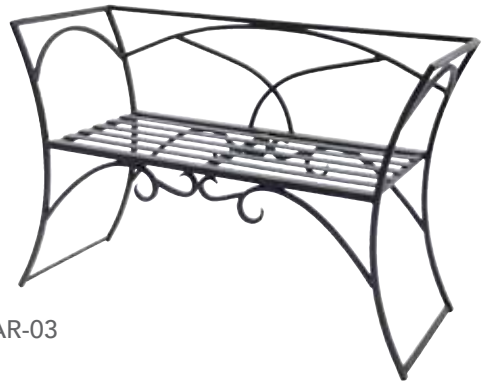

AR-03

Arbor Benches 39½"W x 16"D x 26½"H
(15½"H at seat) **Black**

AR-03 with Back

AR-01 Backless



OFB-12B-P Camelback Bench
53"L x 22"D x 40"H at center
Seat height: 17"H; Arm height: 29¾"H
Black



OFP-01-P English Plant Stand
12"sq. top: 36"H
Bottom shelf: 11 $\frac{3}{4}$ "W x 9 $\frac{1}{2}$ "D x 6 $\frac{3}{4}$ "H
Antique Ivory



OFB-01-P Lutyens Bench
54"W x 23"D x 38 $\frac{1}{2}$ "H
Seat height: 18"H x 18 $\frac{1}{2}$ "D; Arm height: 30"H
Natural Oil finish



OFC-02-P Folding Chair with Arms
22"W x 23"D x 37"H; Seat Height
Fully assembled
Natural Oil finish





Moon Bunnies Cast Aluminum with *Antique Bronze finish*

MNB-01 Small
4¾" L x 2½" W x 4" H

MNB-02 Large
9" L x 4½" W x 7" H

Statuary

Statuary has been a part of architecture and landscape decoration throughout history. Palaces, temples and grand residences have been opulently adorned with detailed figures of mythological and historic importance.

Whether bathtub Mary or plastic pink flamingo, we still highlight our own important figures or statues in the garden. Create a vignette with a trellis or water feature, or tuck a small creature into a secret space.



Ducks Cast Aluminum with *Bronze finish*

E-09 Hello
18½" L x 6½" W x 11½" H

E-11 Duckling Pair
5" L x 6" H and 4" L x 6½" H

E-10 Bye
13" L x 7½" W x 11½" H



CAT-05 Coy Cat
 8" L x 4½" W x 8½" H
 Cast Aluminum with **Bronze finish**



FRG-01 Frog 8" L x 5" W x 4½" H
 Cast Aluminum with **Antique Bronze finish**



TUR-01 Sea Turtle
 17" L x 16" W x 5½" H
 Cast Aluminum with **Green Verdi finish**



These hand painted birds include anchoring pins



Inspired by the original pink flamingo lawn ornament, designed in 1957 by our own Don Featherstone of Fitchburg, MA

PC-01
Preening Crane Pair
 9"W x 10"D x 20"H and
 9"W x 13¼"D x 23"H
 Cast Aluminum with
Verdi finish

E-02 Great Egret I
 6"W x 10"D x 43"H
 Cast Aluminum with
**Black, White and
 Yellow finish**



E-04 American Flamingo
 7"W x 13"D x 38"H
 Cast Aluminum with
Pink and White finish



Hérons
 Cast Aluminum with
Blue/Grey Verdi finish

HSB-01
Stately Blue Heron
 8"W x 12½"D x 31½"H

HSB-02
Great Blue Heron
 9½"W x 13¼"D x 43"H



HSB-02

HSB-01

Great Horned Owl, also known as Hoot Owl (*Bubo virginianus*)



OWL-02 Owl II
 7½"W x 4½"D x 12½"H
 Cast Aluminum with
Rustic Bronze finish



DOV-01 Pair of Bronzed Doves
 Looking Down: 7½"L x 3½"W x 4"H
 Looking Back: 7½"L x 5½"W x 5"H
 Cast Aluminum with **Antique Bronze finish**



OWL-01 Owl
 6½"L x 3"D x 6"H
 Cast Aluminum with
Rustic Bronze finish

Northern Saw-whet Owl
 (*Aegolius acadicus*)

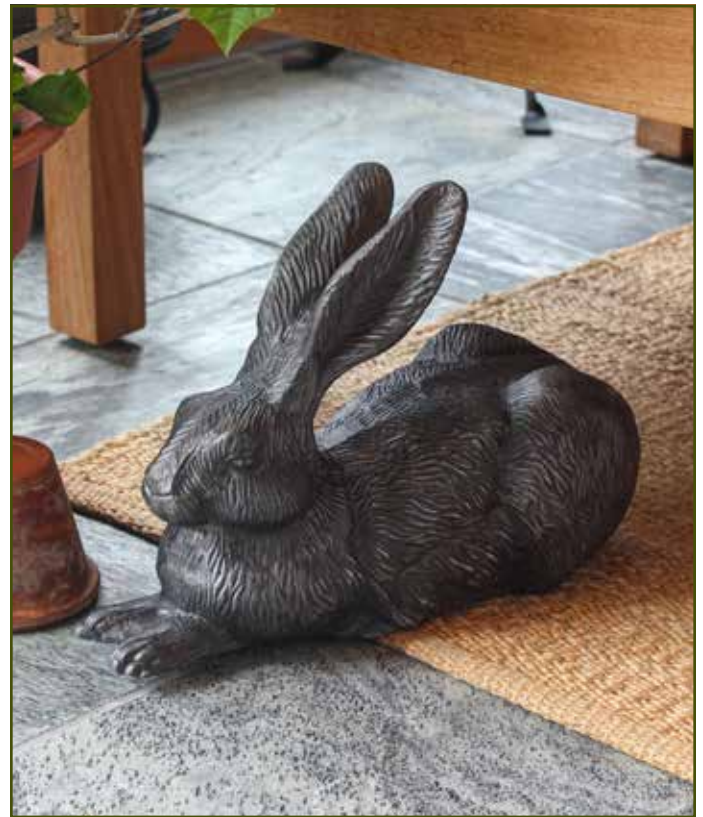

E-12C Rabbit 13¼"L x 4½"W x 9¼"H
 Cast Aluminum with **Charcoal finish**



Short Stands Black

GBS-09 Spider
8"W x 10"H

GBS-10 Helix
13" dia. x 11"H



Trestle Stands Black

GBS-07 Trestle I
7½" dia. base; 8¼" H

GBS-14 Trestle II
8½" dia. base; 13½" H

GBS-14S Trestle III
6½" dia. base; 13¾" H



Multi-use Stands Black

GBS-20 12"H; 7½" dia. top ring
GBS-21 13½"H; 10" dia. top ring



GBS-15 Daffodil Stand
11"W x 21¼"H; Folds for easy storage and shipping **Black**



Toadstool Stands Graphite

GBS-11 Small
5¾"W x 12½"H

GBS-12 Large
7¼"W x 21½"H



GBS-13 Petals Globe Stand
8½"W x 32"H
For 6" and 10" dia.
Black



Spiked to install in-ground Black

GBS-05
25¾"H;
9¾" dia.
footprint

GBS-06
32"H;
12¼" dia.
footprint

GBS-08
33½"H;
11" dia.
footprint



Footed for hard surfaces Black

GBS-02
20"H;
10½" dia.
footprint

GBS-03
26½"H;
12½" dia.
footprint

GBS-04
12"sq.; 32"H
removable
baseplate, hand
forged leaves

Crackle Glass Gazing Globes

11 colors offered in three sizes, variation of color saturation may occur among sizes



Crackle Glass Toadstools 9" dia. x 6"H (including neck) offered in 11 colors

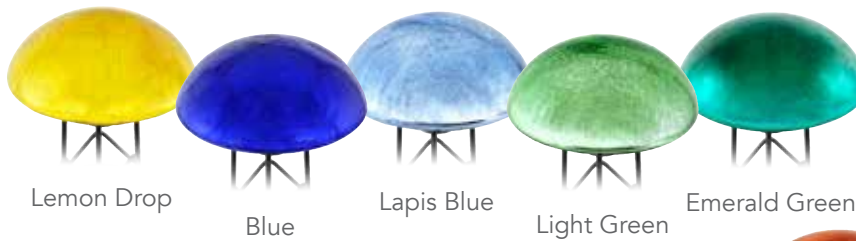

COLOR	Toad stool	6" Globe	10" Globe	12" Globe
Blue	TS-BL-C	G6-BL-C	G10-BL-C	G12-BL-C
Lapis Blue	TS-BLL-C	G6-BLL-C	G10-BLL-C	G12-BLL-C
Light Green	TS-LG-C	G6-LG-C	G10-LG-C	G12-LG-C
Emerald Green	TS-EG-C	G6-EG-C	G10-EG-C	G12-EG-C
Fern Green	TS-FG-C	G6-FG-C	G10-FG-C	G12-FG-C
Mandarin	TS-M-C	G6-M-C	G10-M-C	G12-M-C
Plum	TS-PL-C	G6-PL-C	G10-PL-C	G12-PL-C
Red	TS-RD-C	G6-RD-C	G10-RD-C	G12-RD-C
Silver	TS-S-C	G6-S-C	G10-S-C	G12-S-C
Teal	TS-T-C	G6-T-C	G10-T-C	G12-T-C
Lemon Drop	TS-Y-C	G6-Y-C	G10-Y-C	G12-Y-C



All cones have drain holes at the bottom



Votive Sparkle Cones with Spiked Bottoms
15¾" overall height; packs of six in the colors listed below; use with votives or tea lights
Steel bottoms are **Bronze finish**

- | | |
|---------------------|------------------------------|
| SC-02RD Red | SC-02Y Yellow |
| SC-02DB Dark Blue | SC-02LB Light Blue |
| SC-02DG Dark Green | SC-03 Assorted - one of each |
| SC-02LG Light Green | |



Crackle Glass

Our glass emits beautiful light. In all our glass items, the color is added in the silica mixture during the melting process and not surface painted, they are fade resistant.



Solar Crackle Vases
Colored glass and Galvanized wire handles

- 4¼" dia. x 7"H
- SL-SV01BLL Blue Lapis
- SL-SV01Y Yellow
- SL-SV01T Teal





Solar Caps contain light sensors, long lasting LED bulbs and nickel-metal hydride batteries which activate at dusk and turn off at dawn.



8" Solar Sparkle Cones with 30"H Stake see chart for item numbers

Solar Sparkle Cones with Spiked Bottoms 16½"H Steel bottoms in *Bronze finish*



COLOR	With 30"H Stake	With Spiked Bottoms
	3/pk	3/pk
Red	SL-SC01RD-S	SL-SC02RD
Yellow	SL-SC01Y-S	SL-SC02Y
Dark Green	SL-SC01DG-S	SL-SC02DG
Light Green	—	SL-SC02LG
Emerald Green	SL-SC01EG-S	—
Dark Blue	SL-SC01DB-S	SL-SC02DB
Light Blue	SL-SC01LB-S	SL-SC02LB



SC-04 One of each color
6/pk of solar cones with spiked bottoms





Corona Brackets
1"W section **Black**

B-45 24" Bracket
23½"L x 2"W x 19"H

B-44 18" Bracket
17½"L x 2"W x 17"H

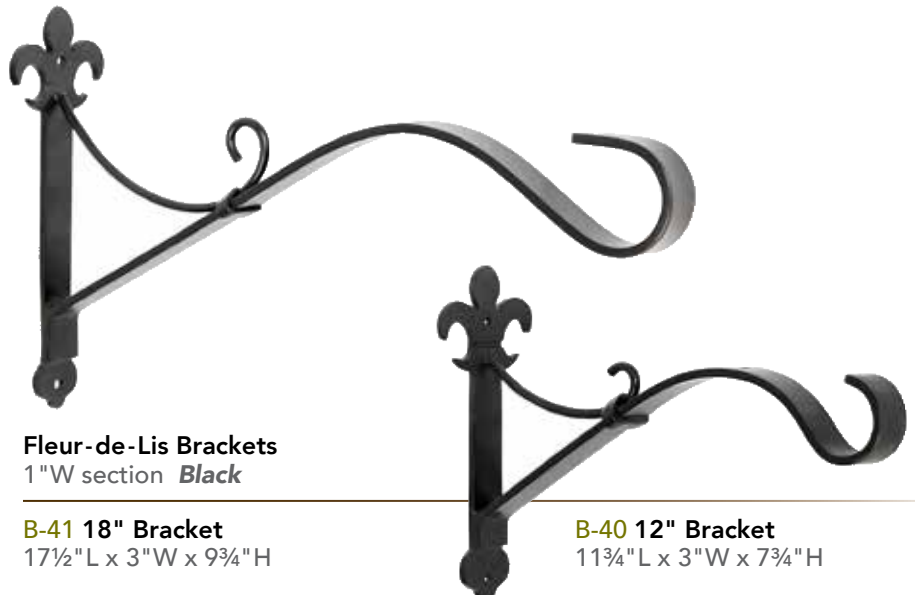

Fleur-de-Lis Brackets
1"W section **Black**

B-41 18" Bracket
17½"L x 3"W x 9¾"H

B-40 12" Bracket
11¾"L x 3"W x 7¾"H

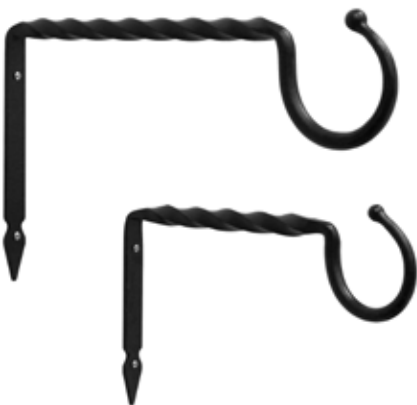

Jumbo Brackets
Black

B-25 14"L x 8"H

B-26 17½"L x 10"H



All-purpose Brackets **Black**

B-28 18"L x 16½"H

B-27 12"L x 12"H

Stainless steel screws included

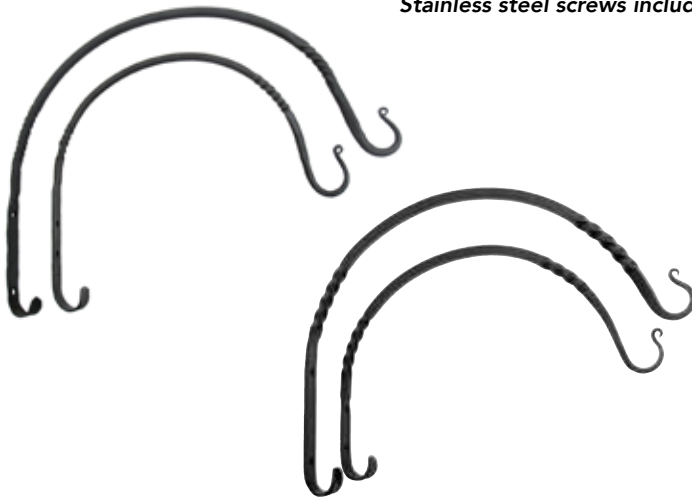

Arc Brackets Black

Standard

WB-03 13"L x 10½"H

WB-04 18½"L x 13½"H

Heavy Duty Square stock

WB-03HD 14"L x 9¾"H

WB-04HD 17½"L x 13"H



Wall Brackets Black

WH-03 3 Hook
14"W x 3½"H;
2¼"D from wall

WH-04 4 Hook
18½"W x 3½"H;
2¼"D from wall

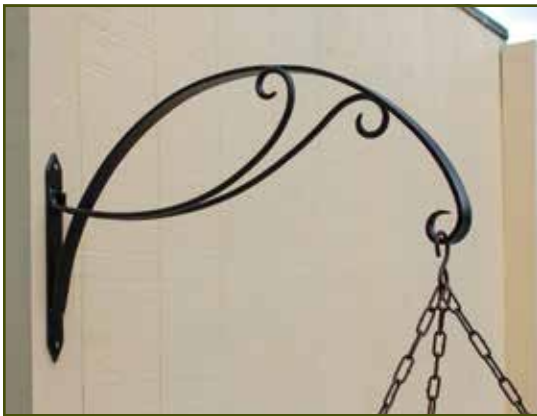

B-36 Scroll Bracket 23"L x 10¾"
Designed for hanging baskets up to
23" diameter **Black**

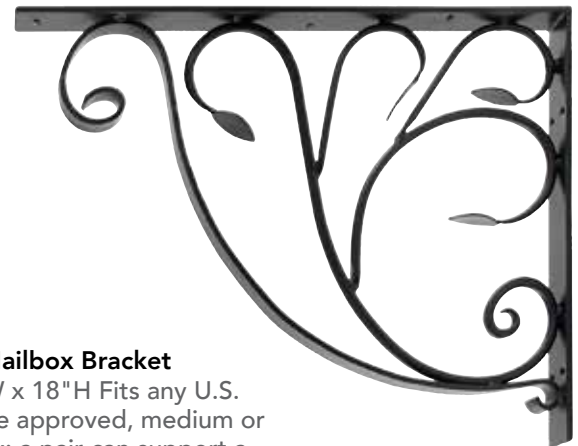

B-10
Leafy Leaf Mailbox Bracket
21"L x 1¾"W x 18"H Fits any U.S.
Postal Service approved, medium or
large mailbox; a pair can support a
heavy shelf or flower box
Black



B-21 Scroll Shelf Bracket Black
10"L x 1"W x 9¾"H
Sold as a pair



B-20 Ionic Shelf Bracket Black
9½"L x 1"W x 9¼"H
Sold as a pair

All wrought iron items have a powder coated finish



B-101-2

Leaf Brackets

Sold in sets of 2 **Black**

B-101-2 Squiggle Leaf

15¾" L x 3" W x 4½" H

B-102-2 Straight Leaf

15½" L x 2¾" W x 5¼" H



B-29L O-Hook

5¾" L x 3¾" H

For use with bells, windchimes, etc.

Graphite



B-35-2 Lantern Bracket

10" L x 7" H;
Sold in sets of 2
Black

SBM-03 Maple Leaf Swivel Bracket

13" L x 3¾" W x 5½" H
Black

SS-01-3 Mini S-Hook

4¼" L Link together
Sold in sets of 3
Black



EM-02-2 Maple Leaf Extender

18" L x 3" W
Sold in sets of 2
Black



Extenders w/ Twist

Sold in pairs
¼" round stock
Black

BGE-18-2 18" L

BGE-24-2 24" L

BGE-30-2 30" L

BGE-48-2 46" L

S-Hangers

Black

TSW-11-2 12" H
Set of 2

TSW-10-2 30" H
Set of 2



TSW-11-2

Stainless steel screws included



Ginkgo Hooks Antique Iron

SSH-20 Single

Set of 2
4½" L x 4½" W x 2" D

SSH-21 Double

6½" L x 4¼" W
max depth, 2¼" D
Sold individually

Hammered Strap Hooks Antique Iron

SSH-10 J Hook

Set of 2
6½" L x 1½" W x 2" D

SSH-11 S Hook

Set of 2
4½" L x 1½" W x 3¾" D

Sold in pairs, except where noted

Ginkgo and Hammered Strap Hooks are zinc-plated and blackened for a natural Antique Iron finish.

Lodge brackets have biscuit-edge mounting plates and the bold hefty solidity of the Craftsman style. The square-stock flares into the generous curving hooks, with a variety of styles to outfit hall or hearth, tack room or mudroom.

Lodge Brackets *Black*

B-103-2 Double

Set of 2
10" L (6" L at short hook)
2½" sq. mounting plate

B-104-2 Upcurled

Set of 2
7¾" L; 2" W x 3½" H mounting plate

B-105 Y Bracket

11¾" W x 5½" L
2½" W x 3" H mounting plate

B-106-2 Straight

Set of 2
14" L; 2" W x 3" H mounting plate

B-107 Triple Hook

4¼" L; 12¼" W x 3" H mounting plate

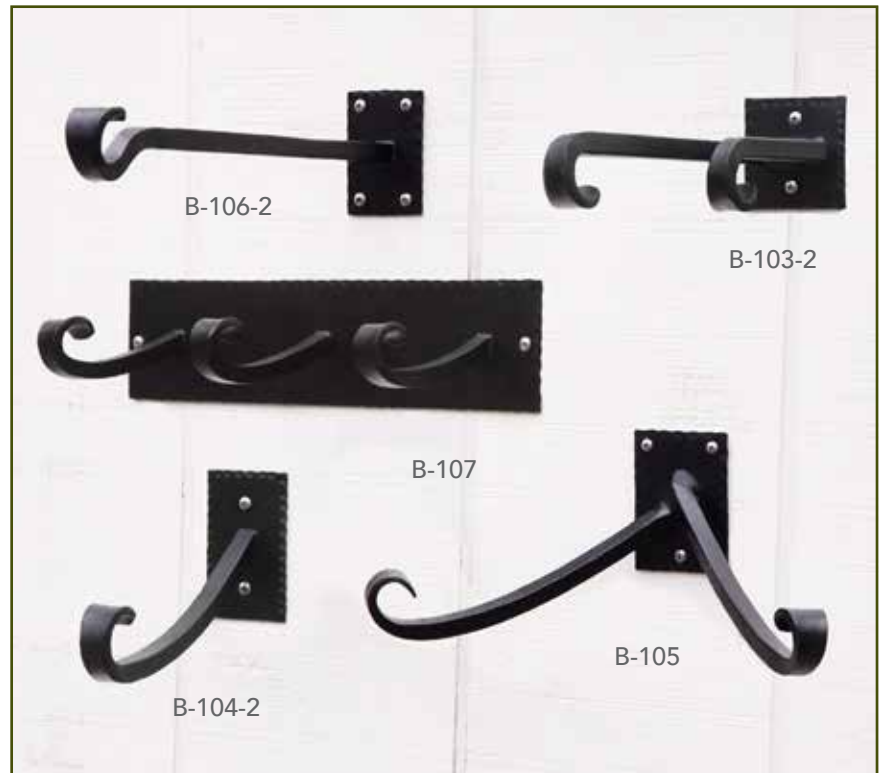

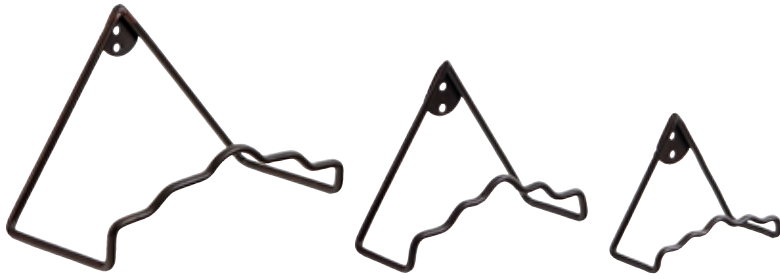
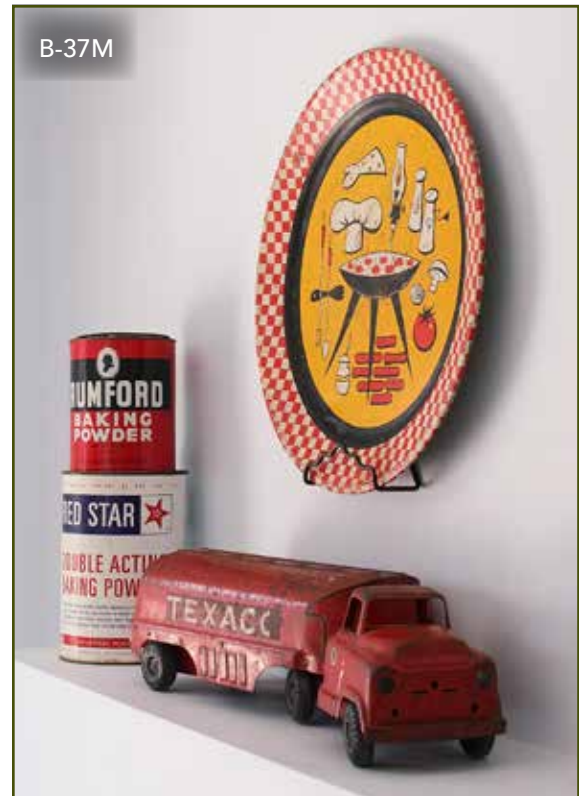

Plate Wall Hangers Sold in Pairs *Roman Bronze*

B-37-2
Large
 8"W x 4"D
 x 5½"H

B-37M-2
Medium
 6¼"W x 2½"D
 x 4½"H

B-37S-2
Small
 4½"W x 2"D
 x 3½"H



B-37M



WS-03Z-36

Vita Wall Shelves *Roman Bronze*

WS-01Z 18"L x 8"W x 8¾"H
Half-Round shelf bracket

WS-02Z 8¼"L x 8¼"W x 3¼"H
Corner shelf bracket

WS-03Z-36 36"L x 6¼"W x 6¾"H
Windowsill shelf bracket
Mango Wood



WS-02Z



WS-01Z



WS-03Z-36



WS-01Z

Stainless steel screws included

Point of Purchase Display

- ✓ Freestanding and compact; needs very little floor space
- ✓ Conveniently displays an assortment of our popular hooks and brackets
- ✓ Shipped already assembled, labeled, ready for display
- ✓ Provides easy customer access
- ✓ Each component has its pre-marked, appropriately fitted cubby space
- ✓ Allows for quick and easy inventory check
- ✓ Items are tagged with mounting hardware and UPC-coded labels



DSP-03 POP Display Stand
 24½"W x 20"D x 70"H
 Contents are listed and shown on this page.
 For information on exact quantities, see price list;
 All items are **Black**

Item	Description	Dimension
Brackets		
TSH-04	8" upcurled	9"L x 8"H
TSH-05	12" upcurled	12"L x 10"H
TSH-06	18" upcurled	17½"L x 14¼"H
TSH-07	6" angled upcurled	6"L x 4"H
TSH-08	12" angled upcurled	12½"L x 6½"H
TSH-09	6" straight upcurled	6"L x 4"H
TSH-10	15" straight upcurled	15"L x 4½"H
TSH-11	9" downcurled	8½"L x 8½"H
TSH-12	12" straight downcurled	12½"L x 4½"H
Hooks		
TSH-13	5" Ceiling / Wall Hook	2½"D x 6"H
TSH-15	3" J-Hook	1½"D x 3"H
TSH-16	8" S-Hook	¾"D x 8"H
Flowerpot Rings		
SFR-04	4" ring	4½" dia. x 6"H
SFR-06	6" ring	6¼" dia. x 6"H
SFR-08	8" ring	8" dia. x 6"H

Free Display Stand with purchase of this complete package. It includes all items as listed above, plus an extra set of each item premounted and labeled on the display.

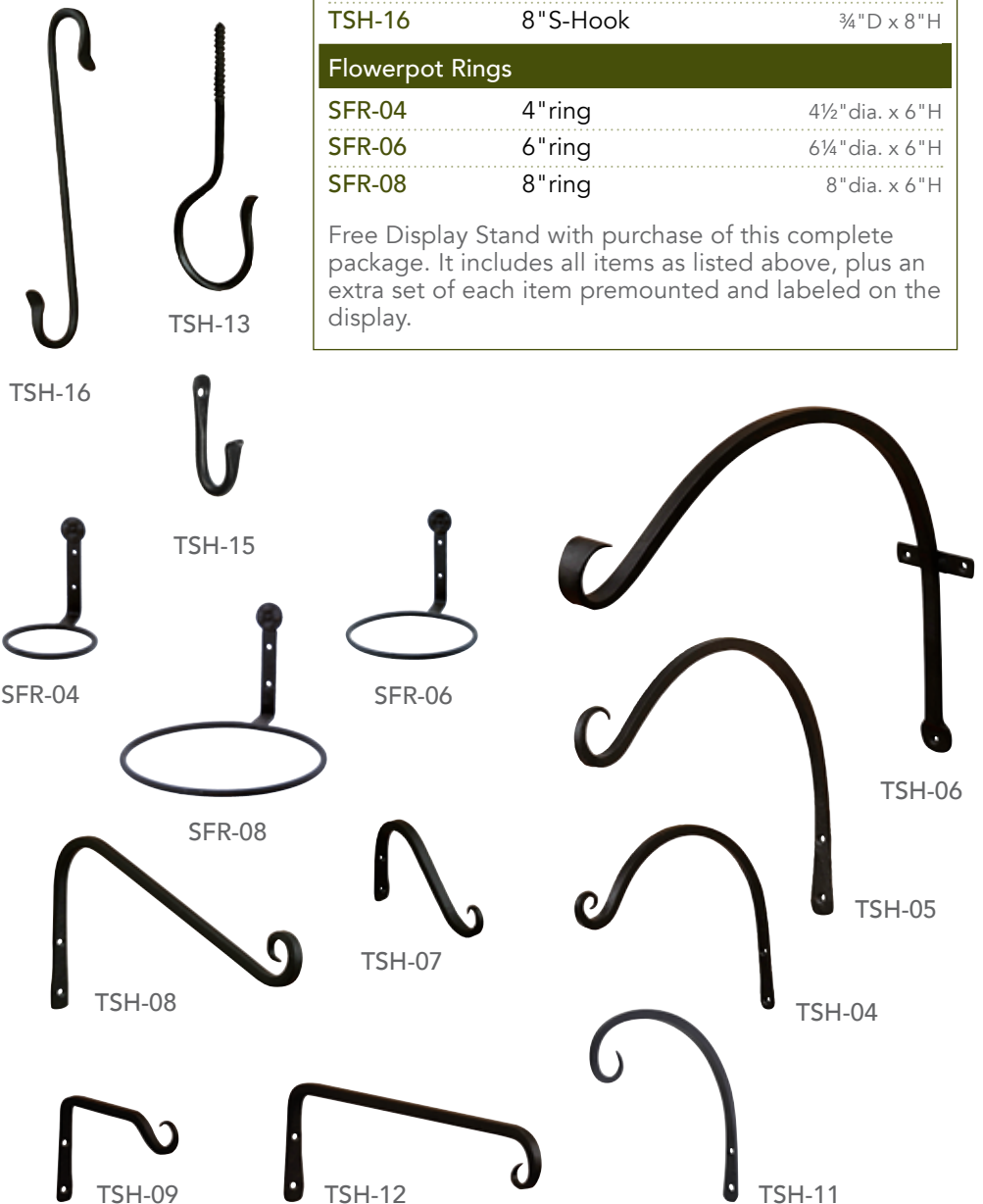



SSE-01



Extender Hooks Black

- | | | |
|--------------------------------------|--------------------------------------|--------------------------------------|
| SSE-01
1¾" hook
x 11½"H | SSE-02
2¼" hook
x 15¾"H | SEL-03
5½" hook
x 12¼"H |
|--------------------------------------|--------------------------------------|--------------------------------------|



Standard Arc Brackets Black
Beautifully detailed with two sets of twists and a curled up hook end

- | |
|----------------------------|
| WB-04 18½"L x 13½"H |
| WB-03 13"L x 10½"H |

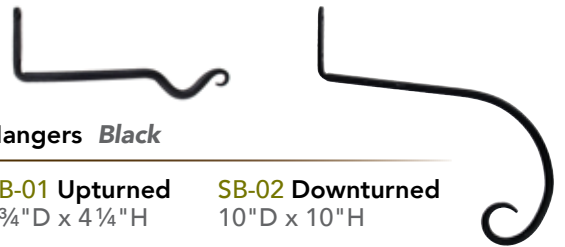

Hangers Black

- | | |
|--------------------------------------|--|
| SB-01 Upturned
7¾"D x 4¼"H | SB-02 Downturned
10"D x 10"H |
|--------------------------------------|--|

"S" Series Hardware

Utilitarian and beautiful, the "S" Series optimizes the use of blacksmithy in key areas, making it price competitive. All items are finished in a Black Powder coat. These items can be ordered with or without the display stand.

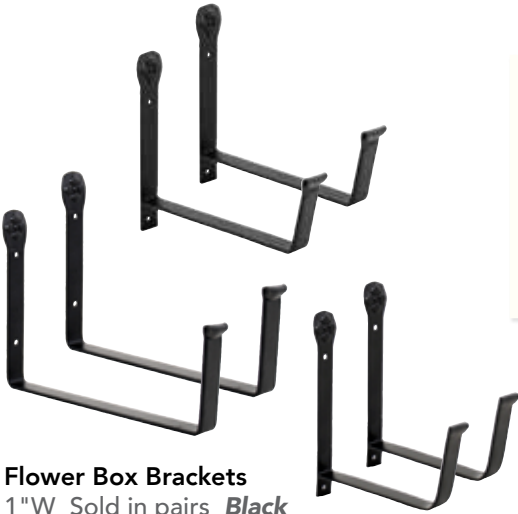

Flower Box Brackets
1"W Sold in pairs **Black**

- | | | |
|---------------------------------------|--------------------------------------|--------------------------------------|
| SFB-03
10"D at base:
8"H | SFB-02
8"D at base:
8"H | SFB-01
6"D at base:
8"H |
|---------------------------------------|--------------------------------------|--------------------------------------|

Arc Brackets Black

- | |
|--------------------------------|
| SCH-02
15"L x 11"H |
| SCH-01
10¾"L x 11¼"H |



J-Hook Wall Brackets
Black

- | | |
|---------------------------------|-------------------------------|
| SSH-02
2½"D x
6¼"H | SSH-01
2"D x
4"H |
|---------------------------------|-------------------------------|



B-29L O-Hook
5¾"L x 3¾"H For use with bells, wind chimes, etc. **Graphite**



Garden Tool Brackets Black

- | | |
|---|--|
| SWB-02 Five hooks
Extends 4" from wall; 20"W
Mounting holes: 16" apart | SWB-01 Four hooks
Extends 4" from wall; 9¼"W x
6¼"H Center mounting |
|---|--|





DSP-05 POP Display Stand
24½"W x 20"D x 70"H
Contents listed here, photos opposite
For information on exact quantities,
see price list; All items are **Black**

Additional brackets sold individually, for larger lanterns, hanging baskets, bells and shelves, shown on pgs. 58-59, 66

Point of Purchase Display

- ✓ Freestanding and compact; needs very little floor space
- ✓ Conveniently displays an assortment of our popular hooks and brackets
- ✓ Shipped already assembled, labeled, ready for display
- ✓ Provides easy customer access
- ✓ Each component has its pre-marked, appropriately fitted cubby space
- ✓ Allows for quick and easy inventory check
- ✓ Items are tagged with mounting hardware and UPC-coded labels

Item	Description	Dimension
------	-------------	-----------

Arc Brackets

SCH-01	10" Arc	10¾"L x 11¼"H
SCH-02	16" Arc	15"L x 11"H
WB-03	12" Arc	13"L x 10½"H
WB-04	18" Arc	18½"L x 13½"H

Extenders

SSE-01	12"	1¾"D x 11½"H
SSE-02	15"	2¼"D x 15¾"H
SEL-03	5¾"	5½"D x 12¼"H

Flower Box Brackets (pair)

SFB-01	6"	6"D x 8"H
SFB-02	8"	8"D x 8"H
SFB-03	10"	10"D x 8"H

Garden Tool Brackets

SWB-01	4-Hook	9¼"W x 4"D x 6¼"H
SWB-02	5-Hook	20"W x 4"D x 2½"H

Wall Hangers/Brackets

B-29L	O-Hook, 6"	5¾"L x 3¾"H
SSH-01	J-Hook, 4"	2"L x 4"H
SSH-02	J-Hook, 6"	2½"L x 6¼"H
SB-01	Upturned, 7¾"	7¾" dia. x 4¼"H
SB-02	Downturned, 10"	10" dia. x 10"H

Free Display Stand with purchase of this complete package. It includes all items as listed above, plus an extra set of each item premounted and labeled on the display.



B-43

Morris Brackets Black

B-42 17" bracket
17"L x 16½"H

B-43 24" bracket
23½"L x 17"H



B-43

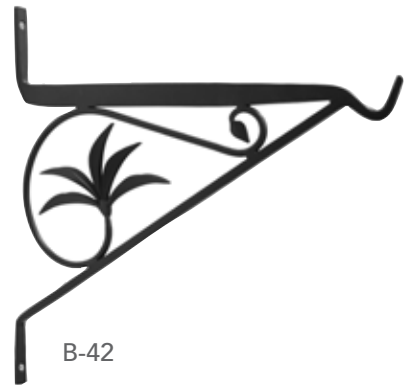

B-42



BGP-08

Angled Poles Black

BGP-08 45° Angle
19½"L x 24"H
Clamp fits railings up to 2¾" thick

BGP-09 45° Angle
18½"L x 21"H

BGP-09S 45° Angle
13"L x 15½"H



BGP-09S

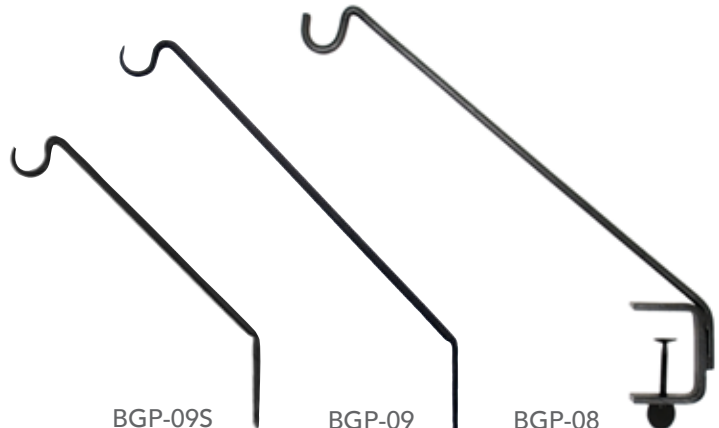

BGP-09S

BGP-09

BGP-08

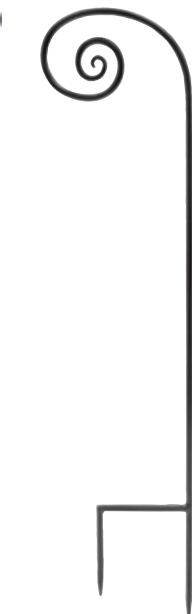

NEW PYS-02-2
Fiddlehead Poles
 10"W x 42"H
 Set of 2 *Graphite*



Clamp-On String Light Pole



SFP-01
Single Fixed Handrail Pole
 13"W x 34½"H
 Clamp fits railings up to 2¾" thick
Black

Adjustable Handrail Poles *Black*

BGP-07 12¼"W x 40"H
 Clamp fits railings up to 2¾" thick

TSW-02 12½"W x 40¾"H
 Clamp fits railings up to 3½" thick

TSW-03 15"W x 28¼"H
 Clamp fits railings up to 4¾" thick

TSW-04-2 46"H
 Clamp fits railings up to 3½" thick
 Set of 2 For string lights

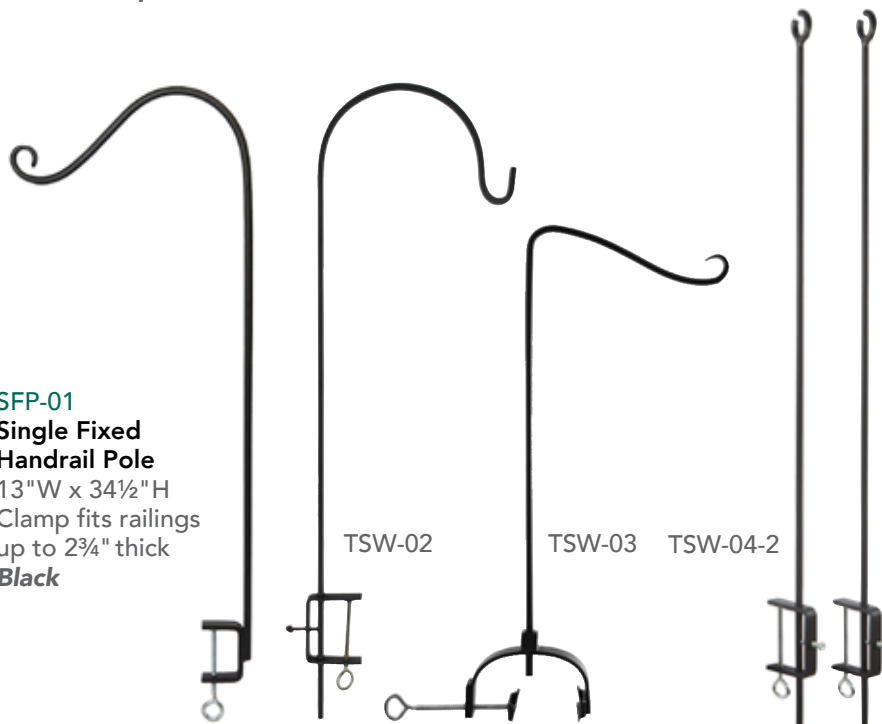



C-20C Flower Box with SFB-02C Clamp-On Brackets, pg.75



Copper Plated Flower Boxes

- | | | |
|--|--|--|
| C-08C Small
22"W x
6 ³ / ₈ "D x 5"H | C-20C Medium
24"W x
9 ¹ / ₂ "D x 7 ¹ / ₂ "H | C-21C Large
35 ¹ / ₄ "W x
11"D x 9 ¹ / ₂ "H |
|--|--|--|



VFB-05 Flower Box with SFB-02 Wall Mount Brackets, pg.75



Green Flower Boxes *Green Patina*

- | | | |
|---|---|---|
| C-08 Small
22"W x
6 ³ / ₈ "D x 5"H | VFB-05 Medium
24"W x
9 ¹ / ₂ "D x 7 ¹ / ₂ "H | VFB-06 Large
35 ¹ / ₄ "W x
11"D x 9 ¹ / ₂ "H |
|---|---|---|



C04-K4

C-04
Embossed
Flower Box
Galvanized Steel
24"W x 8¹/₂"D x 6"H

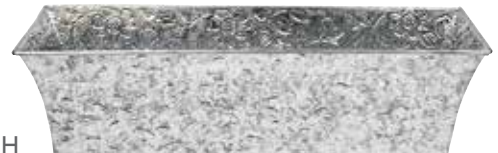

Handrail Flower Box Kits for C-04 and C-09C Flower Boxes

- | | |
|--|--|
| C04-K4 consists of
C-04 Flower Box and
BGK-13 2x4 Bracket | C09C-K4 consists of
C-09C Flower Box and
BGK-13 2x4 Bracket |
| C04-K6 consists of
C-04 Flower Box and
BGK-14 2x6 Bracket | C09C-K6 consists of
C-09C Flower Box and
BGK-14 2x6 Bracket |

All metal Flower Boxes have drain holes For details of compatible Brackets, see [pgs.71,74-75](#)

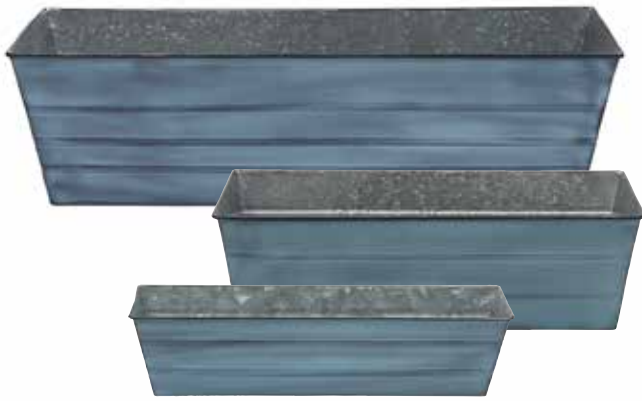

Nantucket Blue Flower Boxes *Blue Patina*

- | | | |
|---|---|---|
| C-08NB Small
22"W x
6 ³ / ₈ "D x 5"H | C-20NB Medium
24"W x
9 ¹ / ₂ "D x 7 ¹ / ₂ "H | C-21NB Large
35 ¹ / ₄ "W x
11"D x 9 ¹ / ₂ "H |
|---|---|---|



Cape Cod White Flower Boxes *White Patina*

- | | | |
|--|--|--|
| C-08W Small
22"W x
6 ³ / ₈ "D x 5"H | C-20W Medium
24"W x
9 ¹ / ₂ "D x 7 ¹ / ₂ "H | C-21W Large
35 ¹ / ₄ "W x
11"D x 9 ¹ / ₂ "H |
|--|--|--|



Plain Copper Plated Flower Boxes

- | | |
|---|--|
| C-82C Large
35"W x 10 ¹ / ₂ "D x 10"H
Fits B-32 Wall Bracket,
see pg.71 | C-09C Medium
23 ¹ / ₄ "W x 7 ³ / ₄ "D x 7 ¹ / ₂ "H
Also offered in kits with
Handrail Brackets |
|---|--|



NEW Flower Box Tray Kits
Patina Finish

Small Flower Box Tray Kits
19¾"W x 6⅝"D x 5⅜"H

- | | | |
|-------------------------------|--------------------------------|--------------------------------|
| C-08-T
Green Patina | C-08NB-T
Blue Patina | C-08W-T
White Patina |
|-------------------------------|--------------------------------|--------------------------------|

Medium Flower Box Tray Kits
21¾"W x 9¼"D x 7¼"H

- | | | |
|--------------------------------|--------------------------------|---------------------------------|
| C-20NB-T
Blue Patina | C-20W-T
White Patina | VFB-05-T
Green Patina |
|--------------------------------|--------------------------------|---------------------------------|

For container growing on covered porches, balcony tabletops and sunny windowsills, these galvanized steel drip trays protect surfaces by keeping excess water contained. Available for Small and Medium patina flower boxes, in matching finishes.



C-20NB-T



C-20W-T

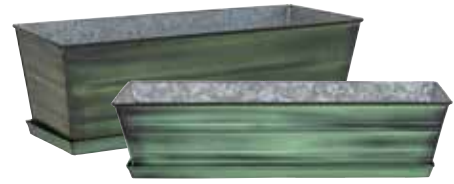

VFB-05-T

C-08NB-T

C-08W-T

C-08-T



TR-C-08-2

NEW Flower Box Trays
Patina Finish

Small Trays Sets of 2
19¾"W x 6⅝"D x 5⅜"H

- TR-C-08-2**
Green Patina
- TR-C-08NB-2**
Blue Patina
- TR-C-08W-2**
White Patina

Medium Trays Sets of 2
21¾"W x 9¼"D x 7¼"H

- TR-C-20NB-2**
Blue Patina
- TR-C-20W-2**
White Patina
- TR-VFB-05-2**
Green Patina

TR-C-20W-2



TR-C-08W-2

TR-C-20NB-2

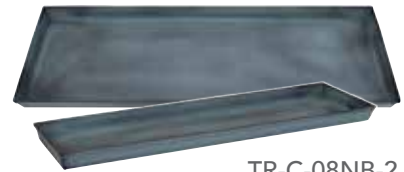

TR-C-08NB-2

TR-VFB-05-2

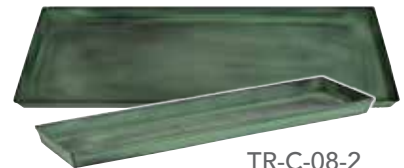

TR-C-08-2

All wrought iron items have a powder coated finish

B-15

Rookwood Brackets

1¼"W x 12½"D x 11"H

For large flowerboxes or shelves

Sold in pairs **Black**



C-101

Solid Copper Flower Box

35"W x 11¼"D x 9¼"H

Drain holes provided

Satin Copper finish



B-51

Rookwood Window Box

Holder: 36"W x 12"D x 10"H

Box: 35"W x 11¼"D x 9¼"H

Brackets: 1¼"W x 12½"D x 11"H

Includes wrought iron decorative casing with solid copper windowbox and two support brackets

Black, Satin Copper



B-32

Scrolls Wall Bracket **Black**

24"W x 10½"D x 9½"H



Handrail Brackets

6¼"D at base: 5"H **Black**

Flower Box Kits shown on [pgs. 68-69](#)

BGK-13 for 2x4 railing

BGK-14 for 2x6 railing



Flower Box Stand Kits

Decorative wrought iron stands for flower boxes add a perfect touch of structure and elegance to any garden, deck or patio space. Ideal for growing ornamental or edible plants on porches and balconies alike. Pair any of our 36" flower boxes, in four finishes, with your choice of stand.



C-21C-S2

Bella Stand Flower Box Kits

35¼"W x 11"D x 22¾"H

Black, Patina or Copper Plated

C-21C-S2 Copper Plated

C-21W-S2 White Patina

C-21NB-S2 Blue Patina

VFB-06-S2 Green Patina



C-21NB-S3

25" Flora Stand Flower Box Kits

35¼"W x 11"D x 25¾"H

Black, Patina or Copper Plated

C-21C-S3 Copper Plated

C-21W-S3 White Patina

C-21NB-S3 Blue Patina

VFB-06-S3 Green Patina



C-21W-S4

30" Flora Stand Flower Box Kits

35¼"W x 11"D x 30"H

Black, Patina or Copper Plated

C-21C-S4 Copper Plated

C-21W-S4 White Patina

C-21NB-S4 Blue Patina

VFB-06-S4 Green Patina



C-21C-S4

C-21C-S3



VFB-06-S2

C-21NB-S4



VFB-06-S4 & VFB-06-S3

Odette Stand Flower Box Kits
Black, Patina or Copper Plated

Medium Flower Box and Stand Kits

24"W x 10½"D x 11½"H

C-20C-S Copper Plated

C-20W-S White Patina

C-20NB-S Blue Patina

VFB-05-S Green Patina

Large Flower Box and Stand Kits

35¼"W x 11"D x 14¾"H

C-21C-S Copper Plated

C-21W-S White Patina

C-21NB-S Blue Patina

VFB-06-S Green Patina



C-21C-S

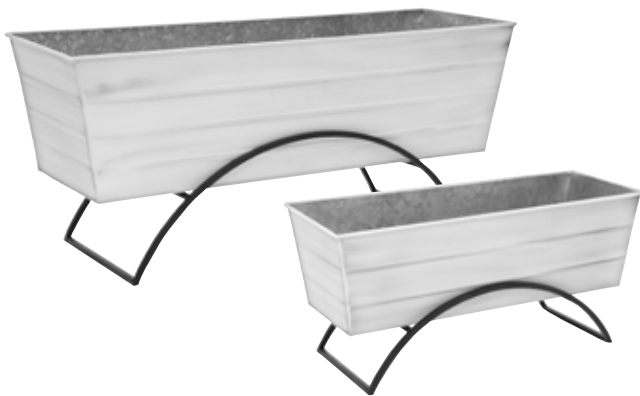

C-21W-S

C-20W-S



VFB-05-S



SMALL Flower Boxes		
For 4" Rails	For 6" Rails	
BGK-13-08	BGK-14-08	
C-08 Green Patina	C08-K4	C08-K6
C-08C Copper Plated	C08C-K4	C08C-K6
C-08NB Blue Patina	C08NB-K4	C08NB-K6
C-08W White Patina	C08W-K4	C08W-K6

MEDIUM Flower Boxes	
For 6" Rails	
BGK-14-20	
C-20C Copper Plated	C20C-K6
C-20NB Blue Patina	C20NB-K6
C-20W White Patina	C20W-K6
VFB-05 Green Patina	VFB-05-K6

LARGE Flower Boxes	
For 6" Rails	
BGK-14-21	
C-21C Copper Plated	C21C-K6
C-21NB Blue Patina	C21NB-K6
C-21W White Patina	C21W-K6
VFB-06 Green Patina	VFB-06-K6



BGK-14-08



BGK-13-08



BGK-14-21



BGK-14-20

Handrail Brackets Sold in Pairs
Stainless steel screws provided **Black**

BGK-13-08 Fits 4"W rail
6¾"W at top: 4"H

BGK-14-20 Fits 6"W rail
9¾"W at top: 5"H

BGK-14-08 Fits 6"W rail
6¾"W at top: 4"H

BGK-14-21 Fits 6"W rail
11½"W at top: 6"H



























Clamp-On and Wall Mount Kits

Wall Mount Brackets 1"W Sold in Pairs
Stainless steel screws provided **Black**

- SFB-01
6"D at base: 8"H
- SFB-02
8"D at base: 8"H
- SFB-03
10"D at base: 8"H
- SFB-04
12"D at base: 10"H



C-20W-WM

SMALL Flower Boxes			Wall Brackets SFB-01 6"		Clamp Brackets SFB-01C 6"		MEDIUM Flower Boxes			Wall Brackets SFB-02 8"		Clamp Brackets SFB-02C 8"		LARGE Flower Boxes		Wall Brackets SFB-03 10"	
 C-08 Green Patina	 C08-WM	 C08-RM	 C-20C Copper Plated	 C-20C-WM	 C-20C-RM	 C-21C Copper Plated	 C-21C-WM										
 C-08C Copper Plated	 C08C-WM	 C08C-RM	 C-20NB Blue Patina	 C-20NB-WM	 C-20NB-RM	 C-21NB Blue Patina	 C-21NB-WM										
 C-08NB Blue Patina	 C08NB-WM	 C08NB-RM	 C-20W White Patina	 C-20W-WM	 C-20W-RM	 C-21W White Patina	 C-21W-WM										
 C-08W White Patina	 C08W-WM	 C08W-RM	 VFB-05 Green Patina	 VFB-05-WM	 VFB-05-RM	 VFB-06 Green Patina	 VFB-06-WM										

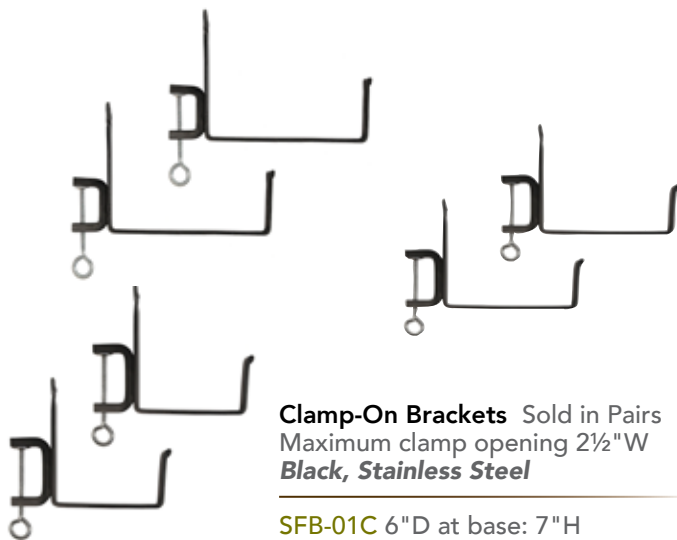

Clamp-On Brackets Sold in Pairs
Maximum clamp opening 2½"W
Black, Stainless Steel

- SFB-01C 6"D at base: 7"H
- SFB-02C 8"D at base: 7¼"H
- SFB-03C 10"D at base: 8"H



SFB-01C



SFR-04C

Clamp-On Rings

For tapered or rimmed pots

Black

SFR-04C 4" Ring

6½" L x 7¼" H
4" dia. Ring
2½" W clamp opening

SFR-06C 6" Ring

8¾" L x 5½" H
6" dia. Ring
2½" W clamp opening

SFR-08C 8" Ring

11" L x 8½" H
8" dia. Ring
2½" W clamp opening



SFR-06C



SFR-04

Wall Mount Rings

For tapered or rimmed pots
Stainless steel screws provided

Black

SFR-04 4" Ring

6¾" L x 6" H
4¼" dia. Ring

SFR-06 6" Ring

8¾" L x 6" H
6¼" dia. Ring

SFR-08 8" Ring

10½" L x 6" H
8" dia. Ring



B-50 Argyle Window Box

30" W x 12½" D x 8" H
Fits one 12" dia. and two 8" dia. pots

Black





WC-07
Watering Carafe
 11" L x 5" W x 10" H; Holds 3.5 pints
 Solid Copper with Solid Brass accents
Brushed finish



WC-08
Windowsill Watering Can
 13" L x 3 1/4" W x 8 5/8" H; Holds 3.5 pints
 Solid Brass *Brushed finish*

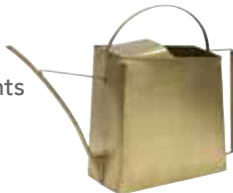

WC-17
Deco Watering Can
 10 1/2" L x 5 1/2" dia. x 8 1/4" H
 Holds 2 pints, Solid Spun Copper
Polished finish



WC-01
Brass Watering Can
 14" L x 6 1/4" dia. x 8 1/2" H
 Holds 2.1 pints, Solid Brass
Antique finish



WC-06
Dainty Copper Watering Can
 12" L x 6 1/4" dia. x 7 1/4" H; Holds 3 pints
 Solid Hammered Copper *Antique finish*





Trestle Plant Stands
Trays: **Galvanized Steel**
Wrought Iron bases: **Black**

WT-03 22" Stand
28" L x 10½" W x 21¼" H

WT-04 27" Stand
32" L x 10½" W x 27¼" H



Plant Trays
Galvanized Steel



TRY-08 Large Tray
28" L x 11" W x 3" D



C-90

C-90 20" Tray
19½" L x 9½" W x 3" D at rim



C-91 24" Tray
23¾" L x 11" W x 3" D at rim



Pair with any of our Wrought iron Folding Plant Stands, CWI-01, CWI-02, CWI-03 and CWI-04 on [pg. 29](#)



GT-03

CWI-02



GT-01



GT-03



GT-02



GT-04

GT-01 20" Tray
20½" L x 17" W x 2" D

GT-03 17" Tray
17" L x 12" W x 2" D

GT-02 28" Tray
28" L x 17" W x 2" D

GT-04 17"sq. Tray
17" L x 17" W x 2" D



TRY-H9



TRY-S10

TRY-S10 10" Square
10½"sq. x 1"D
10"sq. at bottom
Stainless Steel



TRY-S15 15" Square
15"sq. x 1¼"D
13½"sq. at bottom



Copper Plated Trays
Stainless Steel

TRY-H9 Hexagonal
9"L x 8"W x ¾"D ea.
Set of 3



TRY-R8 8" Round
8½"dia. x 1"D ea.
8"dia. at bottom Set of 2



TRY-R12 12" Round
12½"dia. x 1"D
12"dia. at bottom



Long Copper Plated Trays
Stainless Steel

TRY-C20 20"L x 5"W x 1¼"D

TRY-C29 29"L x 5"W x 1¼"D



TRY-C29



TRY-01 with GBS-22



TRY-01

TRY-02



Clear Glass Trays

TRY-01 9" dia. Tray
9" dia. x 1¼"D

TRY-02 10" dia. Tray
10½" dia. x 1½"D



TRY-07-4 Scalloped Rim Recycled Glass Tray
5¾" dia. x ¾"D; Set of 4
Fits in FC-05 Plant Stand, pg. 30



TWI-06L-2



TWI-06S-2

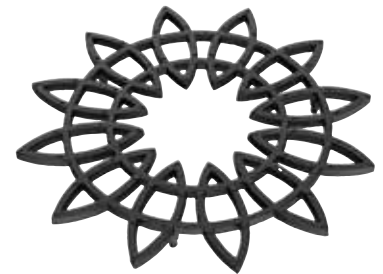

TWI-06L-2

Cast Iron Trivets
Sold as Pairs

TWI-05-2 Leaf
8½"L x 6⅞"W x 1⅞"H

TWI-06S-2 8" Flower
8"Dia. x 1⅞"H

TWI-06L-2 12" Flower
12"Dia x 1⅞"H



TWI-05-2

Teardrop Rooting Vases 4¼" dia. x 7"H; **Crackle Glass**
Interior is etched to make vases translucent, protecting roots from excessive sunlight

SV-01T

Teal

SV-01BLL

Blue Lapis

SV-01Y

Yellow



SV-01Y

SV-01T

SV-01BLL



SV-01BLL



CS-03 Compost Sifter

20"W at handles 4"D, ⅜"x ⅜" mesh
Top rim: 15¼" dia.; Bottom rim: 13¾" dia.
Galvanized Steel

FLAQ-01 Flower Aquarium

6½" dia. x 7¼"H

Our glass aquarium magnifies blossoms so you can view every detail, and it keeps flowers fresh longer than ordinary vases. Fill the globe with water, arrange your flowers in the built-in frog, and seal it shut with a snap.



Garden Helpers

Every gardener struggles to keep garden dirt out of a clean house. Scrape muddy boots clean with our Boot Scraper, remove them with the Boot Jack Cricket, and store on one of our Rubber Boot Trays, available in three size options to fit any hall or mudroom.



X302870 Boot Jack Cricket
9½" L x 4¾" W x 2¾" H
Cast Iron **Black**

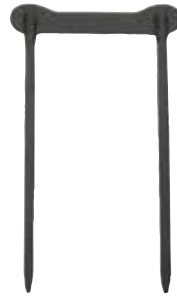

BS-03 Boot Scraper
11" W x 17" H **Black**



HG-01-6

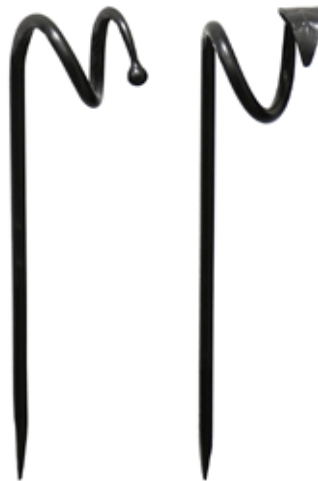

Hose Guards/Guides
14" H Sets of 6 **Graphite**

HG-01-6 Ball
24" L x 1½" D

HG-02-6 Leaf
34" L x 2" D



HG-02-6

All wrought iron items have a powder coated finish



BTS-01
Gardener's Boot Shelf
 36½"W x 16"D x 36½"H
 Shelves: Bottom - 3"H x 16"D
 Middle - 20½"H x 11½"D Top - 30½"H x 7"D
 Sturdy metal mesh shelves **Black**



The handy Gardener's Boot Shelf attractively organizes gardening items in the hall or entryway. Use our rubber BT-01 Boot Tray on the lower shelf. Use the two upper shelves for pots, tools and plants.



BT-01S



BT-01L



BT-01

Boot Trays 14¼"W **Black Natural Rubber**

- BT-01S Small** 24"L x 1½"D
- BT-01 Medium** 34"L x 2"D
- BT-01L Large** 46"L x 1½"D



BT-01L Large Boot Tray

All wrought iron items have a powder coated finish

Knocker Bells

Hand forged wrought iron
Bells can be heard from over
200 feet away

Graphite

WIB-01 Small
4" dia. x 6"H

WIB-02 Medium
6" dia. x 8½"H

WIB-03 Large
8" dia. x 11"H



WIB-03



VHL-07 Raleigh Tavern Lantern

5½"W x 5½"D x 14"H

Candle Holder: 2" dia.

Iron and glass with a decorative
punched roof and a hinged door **Black**

VHL-02

Travis House Lantern

4½"W x 4½"D x 11½"H

Candle Holder: 2¾" dia.

Handcrafted iron with glass sides **Black**

Birdbaths

We offer our full line of metal and glass birdbaths in kits. Choose from wall, railing and over-railing brackets, stakes, and stands.

Our system of threaded bowls with corresponding stakes, wall, pole and deck rail mounting brackets as well as hanging rings, offers the consumer many mix and match options.



Point of Purchase Display

DSP-BBA P.O.P





- ✓ Freestanding unit conveniently displays 8 staked birdbaths and 3 hanging bowls
- ✓ Additional kits may be displayed alongside, boxed with full color labels for easy access
- ✓ Display unit is FREE with purchase of 30 complete birdbath kits, any assortment



All wrought iron items have a powder coated finish



BB-07 Bee Fountain & Birdbath 11½" L x 10¾" W x 2¼" D
Copper Plated Stainless Steel **Polished finish**





Component	Birdbath Kit
Bronze Stake BB-14	BB-07-S 
Over Rail Bracket BGK-10	BB-07-OR2 
Rail Bracket BGK-05	BB-07-RM 
Tripod Stand BBS-08	BB-07-TR 
Wall Bracket BGK-06	BB-07-WM 



BB-07-S
Garden Stake



BB-10 Lilypad Birdbath 12½" L x 11" W x 5¼" H Bowl: 2¾" D
Copper Plated Brass **Antique and Patina finish**





Component	Birdbath Kit
Bronze Stake BB-14	BB-10-S 
Over Rail Bracket BGK-10	BB-10-OR2 
Rail Bracket BGK-05	BB-10-RM 
Tripod Stand BBS-09	BB-10-TR 
Wall Bracket BGK-06	BB-10-WM 



Detail of lily
blossom flower



BB-08 Dogwood Birdbath 12" dia. x 2" D
Copper Plated Stainless Steel bowl
Flower is Solid Brass **White patina**

Component	Birdbath Kit
Bronze Stake BB-14	BB-08-S 
Over Rail Bracket BGK-10	BB-08-OR2 
Rail Bracket BGK-05	BB-08-RM 
Tripod Stand BBS-08	BB-08-TR 
Wall Bracket BGK-06	BB-08-WM 







BB-08-WM
Wall Bracket

BCB-01 Burnt Copper Birdbath 14" dia. x 2½"D
Hammered Copper Plated Stainless Steel *Antique finish*



BCB-01-WM
Wall Bracket





Component	Birdbath Kit
Bronze Stake BB-14	BCB-01-S 
Over Rail Bracket BGK-10	BCB-01-OR2 
Rail Bracket BGK-05	BCB-01-RM 
Tripod Stand BBS-08	BCB-01-TR2 
Wall Bracket BGK-06	BCB-01-WM 



PCB-01 Polished Copper Birdbath 14" dia. x 2½"D
Hammered Copper Plated Stainless Steel *Polished finish*



PCB-01-RM
Rail Bracket





Component	Birdbath Kit
Bronze Stake BB-14	PCB-01-S 
Over Rail Bracket BGK-10	PCB-01-OR2 
Rail Bracket BGK-05	PCB-01-RM 
Tripod Stand BBS-09	PCB-01-TR2 
Wall Bracket BGK-06	PCB-01-WM 



BB-05 Classic Birdbath 12¾" dia. x 2¾"D
Copper Plated Brass *Antique finish*
See [pgs. 92-93](#) for 18" and 24" dia. versions



BB-05-TR
Tripod Stand

Component	Birdbath Kit
Bronze Stake BB-14	BB-05-S 
Over Rail Bracket BGK-10	BB-05-OR2 
Rail Bracket BGK-05	BB-05-RM 
Tripod Stand BBS-08	BB-05-TR 
Wall Bracket BGK-06	BB-05-WM 



All wrought iron items have a powder coated finish



BB-11 Dara Knot Birdbath 10½"L x 10½"W x 2½"D
Copper Plated Brass *Antique finish*





Component	Birdbath Kit
Bronze Stake BB-14	BB-11-S 
Over Rail Bracket BGK-10	BB-11-OR2 
Rail Bracket BGK-05	BB-11-RM 
Tripod Stand BBS-08	BB-11-TR 
Wall Bracket BGK-06	BB-11-WM 



Top view of Dara Knot



BB-04 Aspen Leaf Birdbath 12½"L x 8"W x 1¾"D
Brass *Antique and Verdi finish*





Component	Birdbath Kit
Bronze Stake BB-14	BB-04-S 
Over Rail Bracket BGK-10	BB-04-OR2 
Rail Bracket BGK-05	BB-04-RM 
Tripod Stand BBS-08	BB-04-TR 
Wall Bracket BGK-06	BB-04-WM 



BB-04-OR2
Over Rail Bracket



HBB-01 Heart Shaped Birdbath
11"L x 9½"W x 6"H Bowl: 2¾"D
Copper Plated Stainless Steel *Antique finish*

Component	Birdbath Kit
Bronze Stake BB-14	HBB-01-S 
Over Rail Bracket BGK-10	HBB-01-OR2 
Rail Bracket BGK-05	HBB-01-RM 
Tripod Stand BBS-08	HBB-01-TR 
Wall Bracket BGK-06	HBB-01-WM 







Detail of bird

BB-09 African Daisy Birdbath 16" dia. x 3¼"D
Solid Brass *Antique finish*



Detail of flower





Component	Birdbath Kit
Bronze Stake BB-14	BB-09-S 
Over Rail Bracket BGK-10	BB-09-OR2 
Rail Bracket BGK-05	BB-09-RM 
Tripod Stand BBS-09	BB-09-TR2 
Wall Bracket BGK-08	BB-09-WM2 



BB-09R African Daisy Birdbath 16" dia. x 3¼"D
Solid Brass *Antique and Patina finish*



Detail of flower





Component	Birdbath Kit
Bronze Stake BB-14	BB-09R-S 
Over Rail Bracket BGK-10	BB-09R-OR2 
Rail Bracket BGK-05	BB-09R-RM 
Tripod Stand BBS-09	BB-09R-TR2 
Wall Bracket BGK-08	BB-09R-WM2 



HBBB-01 Hummingbird Birdbath
13¼" dia. x 7¾"H Bowl: 2¾"D; Copper Plated Brass
Solid Brass cast hummingbird *Polished finish*



Detail of bird





Component	Birdbath Kit
Bronze Stake BB-14	HBBB-01-S 
Over Rail Bracket BGK-10	HBBB-01-OR2 
Rail Bracket BGK-05	HBBB-01-RM 
Tripod Stand BBS-09	HBBB-01-TR2 
Wall Bracket BGK-06	HBBB-01-WM 



All wrought iron items have a powder coated finish



BBM-01 Scallop Shell Birdbath 11"L x 11"W x 5¾"H
Bowl: 1¾"D; Brass *Antique and Verdi finish*





Component	Birdbath Kit
Bronze Stake BB-14	BBM-01-S 
Over Rail Bracket BGK-10	BBM-01-OR2 
Rail Bracket BGK-05	BBM-01-RM 
Tripod Stand BBS-08	BBM-01-TR 
Wall Bracket BGK-06	BBM-01-WM 



Detail of bird









BB-02AB Antique With Birds Birdbath
13" dia. x 7"H Bowl: 2¾"D
Hand-wrought botanical shape; Brass *Antique finish*

Component	Birdbath Kit
Bronze Stake BB-14	BB-02AB-S 
Over Rail Bracket BGK-10	BB-02AB-OR2 
Rail Bracket BGK-05	BB-02AB-RM 
Tripod Stand BBS-09	BB-02AB-TR2 
Wall Bracket BGK-06	BB-02AB-WM 



Detail of birds



Component	Birdbath Kit
Bronze Stake BB-14	BBHC-01T-S 
Hanging Ring BBH-01	BBH-02CP 
Over Rail Bracket BGK-10	BBHC-01T-OR2 
Rail Bracket BGK-05	BBHC-01T-RM 
Tripod Stand BBS-08	BBHC-01T-TR 
Short Stand GBS-22	BBHC-01-S1 
Wall Bracket BGK-06	BBHC-01T-WM 



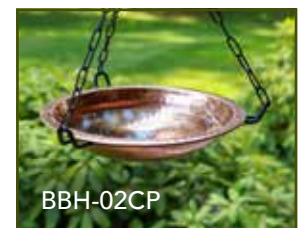

12" Hammered Copper Birdbath
12" dia. x 2¾"D
Copper Plated Brass
Polished finish

BBHC-01T
Bowl threaded

BBHC-01
Bowl non-threaded









BBH-02CP

Component	Birdbath Kit
Bronze Stake BB-14	BBHC-02T-S 
Over Rail Bracket BGK-10	BBHC-02T-OR2 
Rail Bracket BGK-05	BBHC-02T-RM 
Tripod Stand BBS-08	BBHC-02T-TR 
Wall Bracket BGK-06	BBHC-02T-WM 



BBHC-02T Hammered Solid Copper Birdbath
12¼" dia. x 2¾" D; Solid Copper *Satin finish*

Component	Birdbath Kit
Bronze Stake BB-14	BBHC-03T-S 
Hanging Ring BBH-14Z	BBH-03CP 
Over Rail Bracket BGK-10	BBHC-03T-OR2 
Rail Bracket BGK-05	BBHC-03T-RM 
Tripod Stand BBS-09	BBHC-03T-TR2 
Short Stand GBS-25	BBHC-03-S2 
Wall Bracket BGK-06	BBHC-03T-WM 



14" Hammered Solid Copper Birdbath 14" dia. x 3"D
Solid Copper *Satin finish*

BBHC-03T Bowl
threaded

BBHC-03 Bowl
non-threaded



CTBB-02

Cattail Birdbaths Solid Copper Bowls
Wrought Iron Stands *Satin, Black*

CTBB-01 Double
Two 12¼" dia. bowls; 50" H
Ground spikes:
8¾" W apart, 5¼" H

CTBB-02 Single
One 12¼" dia. bowl; 50" H
Ground spikes:
5¾" from stem, 8" H



CTBB-01

All wrought iron items have a powder coated finish



Component	Birdbath Kit
Bronze Tripod Stake BBS-22	BB-12T-TS 
Hanging Ring BBH-18Z	BBH-04CP 
Over Rail Bracket BGK-10	BB-12T-OR2 
Tripod Stand BBS-09	BB-12T-TR2 
Short Stand GBS-25	BB-12-S2 
Wall Bracket BGK-08	BB-12T-WM2 

18" Classic Copper Birdbath
 18" dia. x 2¾" D
 Copper Plated Brass
Antique finish

BB-12T Bowl threaded
BB-12 Bowl non-threaded



BB-12-S19
18" Classic Copper Birdbath with Tulip Stand
 18" dia. top: 28½"H *Antique Copper & Roman Bronze*



Component	Birdbath Kit
Bronze Tripod Stake BBS-22	BB-18-TS 
Over Rail Bracket BGK-10	BB-18-OR2 
Tripod Stand BBS-09	BB-18-TR2 
Wall Bracket BGK-08	BB-18-WM2 



BB-18 Three Hares Birdbath
 18" dia. x 2¾" D; Solid Brass *Antique finish*

BBS-15 Phoebe Birdbath Stand
 18"sq. top: 33"H
Black

**CBB-01-S15 24" Classic Copper
 Birdbath with Phoebe Stand**
 24"dia. top: 33"H
Black

BBS-15

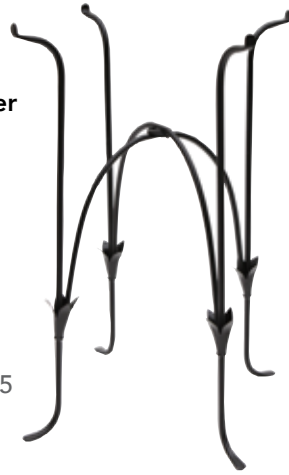

CBB-01-S15



BBS-14 Tripod Ring Stand
 23"dia. top: 28"H
 Ring is removable; legs fold
 for storage **Graphite**



CBB-01-S14



CBB-01

CBB-01 24" Classic Birdbath 24"dia. x 3"D
 Non-threaded bottom
 Copper Plated Brass **Antique finish**

**CBB-01-S14 24" Classic Copper
 Birdbath with Ring Stand**
 24"dia. x 3"D x 28½"H Copper Plated Brass
Antique finish & Graphite

All wrought iron items have a powder coated finish



CBB-02 24" Hammered Birdbath
 Flat bottom; 24" dia. x 2"D
 Copper Plated Brass **Polished finish**

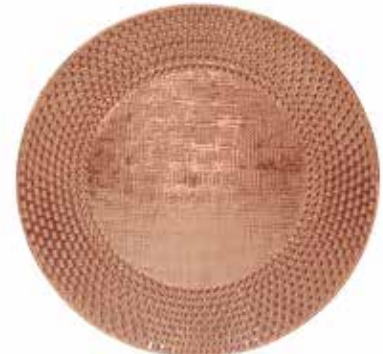

CBB-02

CBB-02-S14 24" Hammered Copper Birdbath with Ring Stand
 Flat bottom; 24" dia. x 2"D x 29"H
 Copper Plated Brass **Polished finish & Graphite**



NEW BBHC-23P
23" Hammered Copper Birdbath for 4x4 Posts
 23" dia. x 5½"H; 3"D; Copper Plated Brass
Antique finish

NEW BBHC-14P
14" Hammered Copper Birdbath for 4x4 Posts
 14" dia. x 4½"H; 2¾"D; Copper Plated Brass
Antique finish

NEW 12" Lolly Birdbaths with Garden Stakes

Solid Brass with embossed pattern and glass enamel colors; Bowls are 12" dia. x 3 1/8"H: 2 1/8"D; Total Height 39"

Bowl and Stake (BB-14)

EBB-02BL-S
Delphinium Blue

EBB-02LP-S
Lilac Purple

EBB-02P-S
Petunia Pink

EBB-02Y-S
Sunflower Yellow

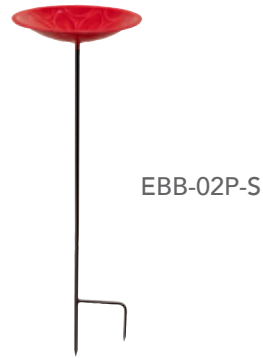

Petunia



Delphinium



Sunflower



Lilac

12" Handblown Crackle Glass Birdbath Kit Combinations

Glass bowls are 12½" dia. x 2½"D; Rounded bottom

BIRDBATH	RAILING BRACKET BGK-05	WALL BRACKET BGK-06	OVER RAILING BRACKET BGK-10	TRIPOD STAND BBS-08	SHORT STAND GBS-22	STAKE BB-14	HANGING RING BBC-01
 COBALT BLUE CGB-01CB	 CGB-01CB-RM	 CGB-01CB-WM	 CGB-01CB-OR2	 CGB-01CB-TR	 CGB-01CB-S1	 GBB-01	 BBH-02CB
 FERN GREEN CGB-05FG	 CGB-05FG-RM	 CGB-05FG-WM	 CGB-05FG-OR2	 CGB-05FG-TR	 CGB-05FG-S1	 GBB-05	 BBH-02FG
 MANDARIN CGB-06M	 CGB-06M-RM	 CGB-06M-WM	 CGB-06M-OR2	 CGB-06M-TR	 CGB-06M-S1	 GBB-06	 BBH-02M
 TEAL CGB-07T	 CGB-07T-RM	 CGB-07T-WM	 CGB-07T-OR2	 CGB-07T-TR	 CGB-07T-S1	 GBB-07	 BBH-02T
 RED CGB-09R	 CGB-09R-RM	 CGB-09R-WM	 CGB-09R-OR2	 CGB-09R-TR	 CGB-09R-S1	 GBB-09	 BBH-02R



CGB-01CB-S1

Threaded Cradles

For use with threaded stakes & brackets

BBC-01 11" dia.

Black

BBC-01Z 11" dia.

Roman Bronze

BBC-01



12" Glass Bowl & Hanging Ring

with BBH-01 Ring

BBH-02CB Cobalt Blue

BBH-02T Teal

BBH-02FG Fern Green

BBH-02R Red

BBH-02M Mandarin

BBH-01

Hanging Ring for 12"

11" dia. ring: 16½" H **Black**



14" Handblown Crackle Glass Birdbath Kit Combinations

Glass bowls are 14" dia. x 2½"D; Flat bottom

BIRDBATH	RAILING BRACKET BGK-05	WALL BRACKET BGK-08	OVER RAILING BRACKET BGK-10	TRIPOD STAND BBS-09	SHORT STAND GBS-25	STAKE BB-14	HANGING RING BBC-14Z
 COBALT BLUE CGB-14CB	 CGB-14CB-RM	 CGB-14CB-WM2	 CGB-14CB-OR2	 CGB-14CB-TR2	 CGB-14CB-S2	 CGB-S-14CB	 CGB-H-14CB
 FERN GREEN CGB-14FG	 CGB-14FG-RM	 CGB-14FG-WM2	 CGB-14FG-OR2	 CGB-14FG-TR2	 CGB-14FG-S2	 CGB-S-14FG	 CGB-H-14FG
 MANDARIN CGB-14M	 CGB-14M-RM	 CGB-14M-WM2	 CGB-14M-OR2	 CGB-14M-TR2	 CGB-14M-S2	 CGB-S-14M	 CGB-H-14M
 TEAL CGB-14T	 CGB-14T-RM	 CGB-14T-WM2	 CGB-14T-OR2	 CGB-14T-TR2	 CGB-14T-S2	 CGB-S-14T	 CGB-H-14T
 RED CGB-14R	 CGB-14R-RM	 CGB-14R-WM2	 CGB-14R-OR2	 CGB-14R-TR2	 CGB-14R-S2	 CGB-S-14R	 CGB-H-14R

Threaded Cradles

For use with threaded stakes & brackets

BBC-02 13" dia.
Black

BBC-02Z 13" dia.
Roman Bronze

BBC-02Z



14" Glass Bowl & Hanging Ring
with BBH-14Z Ring

CGB-H-14CB Cobalt Blue

CGB-H-14T Teal

CGB-H-14FG Fern Green

CGB-H-14R Red

CGB-H-14M Mandarin

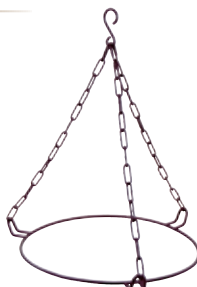

BBH-14Z

Hanging Ring for 14"

13" dia. ring: 17" H **Roman Bronze**



CGB-14R-RM

All wrought iron items have a powder coated finish



FB-14 with CGB-06M



BGK-06
9" Wall Mount
9"L x 1"W x 9"H
Black



BGK-08
11" Wall Mount
11"L x 1 1/4"W x 8"H
Black



BGK-10
Large Over Railing Mount
9 1/4"L closed; x 3 5/8"W x 5 1/4"H
Full length opened: 15 1/4"
Max opening: 6" **Black**



BGK-05
Rail Mount
13"L x 1"W x 12 1/4"H
Black

Ring Stands Black

FB-14 Ring Stand 11" dia x 14"H
Holds our 12" crackle glass and our BBHC-01 metal birdbath bowl

FB-18 Ring Stand 13" dia x 18"H
Holds our 14" crackle glass and our BBHC-03 metal birdbath bowl



BBS-09
Large Tripod Stand
11 1/4"W x 9 3/4"H
Black



BBS-08
Small Tripod Stand
7"W x 5"H
Black



FB-18



FB-14



GBS-25 Short Stand II
14 3/4"W x 14 3/4"D x 6"H
Ring: 13 3/4" dia. **Black**



GBS-22 Short Stand
10"W x 10"D x 5 1/4"H
Ring: 9 1/2" dia. **Black**

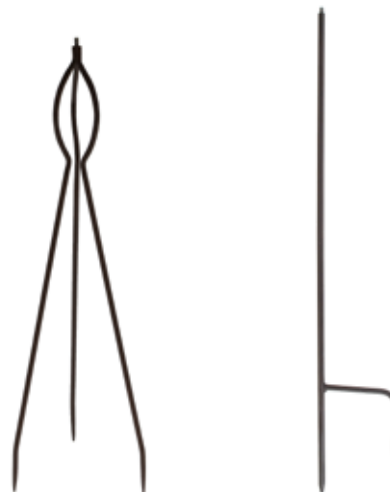

BBS-22
Tripod Stake 31"H
Roman Bronze



BB-14
Birdbath Stake 36"H
Roman Bronze



BB-14



BF-03FB with TSW-11

BF-03FB
Trulli Birdfeeder
 14½" dia. x 15" H
 Holds 5-7 cups of seed
 Steel **French Blue**



BH-20 Bastion Birdhouse
 8" dia. x 11½" H
 Bastion Birdhouse has a back door for cleaning/viewing
 Iron and wood **Hand-Painted**



NEW **VBF-02-OR**
Railing Pineapple Feeder
 Pineapple: 5½" dia. x 12½" H;
 Total Height 17½"
 Steel **Black & Nickel Plated**



VBF-01
Pineapple Feeder
 8" dia. x 18¾" H
 Steel **Black**



Squirrel Baffles/Deflectors

Galvanized Steel with Black powder coat finish



BGD-04 Squirrel Deflector for 4x4 Post 18" dia. x 5¾"H

Deflector can be opened and snapped in place around post. Recommended baffle height is 4 feet above ground and

Includes an adjustable BGC-04 Post Clamp (7½"L)



BGD-04



BGC-04



BGC-01



BGD-03

BGD-03 Hanging Squirrel Deflector

18" dia. x 10"H Recommended baffle height is 4 feet above ground



BGD-01 Squirrel Deflector For Poles

18" dia. x 7¼"H Recommended baffle height is 4 feet above ground

Includes BGC-01 Pole Clamp: 3¼"W x 1¼"D helps adjust the distance of baffle from ground

BGK-04 Birdbath Bracket for Pole

11"L x 3¼"H Male thread on end of bracket will accept all our pre-threaded birdbaths Fits 1" dia. poles

Black



Our Community - Annual Fitchburg Blacksmith Art & Music Festival

We are ardent supporters of the arts in our community, and in 2003, founded the New England Blacksmith, Art and Renaissance Festival held each fall in our town of Fitchburg, Massachusetts, at downtown Riverfront Park, along the bank of the Nashua River. The event is open to the public and has garnered substantial support from the City of Fitchburg, MA, Cultural Council, and neighboring communities.

The festival strives to raise awareness of the art and craft of blacksmithy. It promotes a congenial fellowship among students, hobbyists and professionals alike. Participants bring portable forging stations to the park for a full day of work on projects and competition. Each year a well-known Master Blacksmith is invited to judge the competition and demonstrate skills. These live demonstrations have become a highlight of the event, alongside local crafts, food, music and handcraft sales.

This year's festival will be held September 28th 2024. Join us! For info see: <https://fitchburgforgein.org>



ACHLA Designs Index

Product	Page#	Product	Page#	Product	Page#
Anchoring Pins	22	Flower Aquarium.....	81	Shelf Brackets	59,62
Arbors	1-6,8	Flower/Window Box Kits	70-75	Solar Lights	56-57
Baskets, Harvest	45	Flowerpot Rings.....	76	Sparkle Cones	56-57
Bells	84	Flower Boxes & Brackets	69,71	Square-on-Squares Collection	6-9
Benches		Furniture.....	46-49	Squirrel Deflectors/Baffles.....	100
<i>Backless</i>	46, 48	Garden & Plant Stakes	24	Statuary	50-53
<i>Wrought Iron</i>	48	Gazing Globes & Stands	54-55	Tables, Accent	27, 34
<i>Wood</i>	46-49	Glass Trays	80	Toadstools & Stands	54-55
Birdbaths.....	85-98	Handrail Poles & Brackets.....		Trays	
Birdbath Kits	85-97	66-67,75-76,98	<i>Galvanized</i>	70,78
Birdbath Display Stand	85	Hangers & Extenders.....	60,64	<i>Glass</i>	80
Birdbath Hanging Rings.....	96,97	Hanging Birdbath Rings.....	96,97	<i>Copper</i>	79
Birdbath Stands & Stakes	92-93,98	Hanging Planters.....	36	Trellises.....	7,9,11-26
Birdhouses & Bird Feeders	99	Herb Caddy.....	29	<i>Wall Brackets</i>	11,18,21
Boot Jack & Boot Scraper.....	82	Hooks & Brackets.....	58-67,75-76	Trivets.....	80
Boot Trays & Boot Tray Shelf	83	Hose Guards/Guides.....	82	Tubs, galvanized & copper.....	44-45
Brackets		Kits		Tub & Stand Kits.....	43
<i>Flower/Window Box</i>	71,74-75	<i>Metal Birdbaths</i>	86-95	Tub Stands, Folding	29
<i>Flower/Window Box Kits</i>	70-75	<i>Flower/Window Box</i>	68,70-75	Vases, rooting	78-81
<i>Flower/Window Box Trays</i>	70	<i>Glass Birdbaths</i>	96-97	Watering Cans & Jugs.....	77
<i>Display Stands</i>	63,65	<i>Tubs & Stands</i>	43	Window Boxes & Brackets.....	69,71
<i>Heavy Duty</i>	58-59	Lanterns.....	84		
<i>Multipurpose</i>	58-64	Mushroom Trellis.....	23		
<i>Shelf</i>	59,62	Obelisks & Pylon	7,22,25		
<i>Tool</i>	59,64	Plant Stands	27-41,49		
Chair	49	Plant Hangers.....	36		
Clamp-on Handrail Brackets & Poles.....		Planting Pots	42		
.....	66-67,75,76,98	Plate Hangers.....	62		
Compost Sifter	81	Pole & Post.....	94,100		
Containers, Planting.....	42	Poles, yard & deck-railing	66-67		
Display Stands, POP	63,65,85	Pylons & Obelisks	7,22-25		
Edging, Border Fencing.....	10	Rooting Vases.....	78,81		
Extender Hooks	60,64	Solaria Collection	36-42		
Fence Sections	9-10	Saucers & Plant Trays.....	80		



EBB-02BL-S



WC-07



G10-S-C

GBS-08



TR-C-08-2

AmericasMart Atlanta

The Atlanta International Gift & Home Furnishings Market®
Building @ Living Outdoor/Indoor® The Gardens®. #9-7A

Come see us at

The Atlanta Market Gift & Home Show
Winter Market - Jan 16 - 22, 2024

The AmericasMart Gift & Home Furnishings Show
Summer Market - July 16 - 22, 2024

Minuteman International® parent company of ACHLA Designs®

The largest single source for woodstove
and fireplace accessories. Call to order
your Minuteman catalog.

65 Arbor Way
Fitchburg, MA 01420
Phone: 978-343-7475
Toll Free: 1-800-626-1114
Fax: 978-345-0963

Contact: info@achla.com  
Follow: [@achla_designs](https://www.facebook.com/achladesigns)
www.facebook.com/achladesigns

ACHLA Designs® © 1994 - 2024
Minuteman International® © 1981 - 2024



C-20W-S