



CRESCENT
garden



| | |
|-----------------------------------|----|
| About Us | 04 |
| Catalog and Program Details | 10 |



TruDrop One
Self-Watering Planters 16

| | |
|-------------------------------------------------------|----|
| Cup Tall Planters | 28 |
| Dot Planters | 30 |
| Mod Family of Planters | 34 |
| Nest Planters | 40 |
| Pinch Planters | 46 |
| Rim Planters | 50 |
| Slat Planters | 56 |
| Slat Window Boxes | 58 |
| TruDrop One - Add-ons for Pinch and Slat Planters ... | 60 |
| TruDrop One - Easy Drain System | 63 |
| Replacement Parts for TruDrop Planters | 64 |



TruDrop Flex
Self-Watering Planters 66
Circular +

| | |
|------------------------------------------------------------|----|
| NEW (+) Fold Planters | 74 |
| NEW (+) Ridge Planters | 76 |
| NEW (+) Step Planters | 80 |
| NEW (+) TruDrop Flex - Insert and Water Gauge | 82 |



10 Year Warranty Planters 84

| | |
|------------------------------------|-----|
| Agave Planters | 94 |
| Bleeker Planters | 96 |
| Bowery Planters | 100 |
| Brunello Rolled-Rim Planters | 102 |
| Delano Planters | 104 |
| Delano Oval Bowls | 106 |
| Delano Tall Planter | 108 |
| Eye Planters | 112 |
| Fold Planters | 114 |
| Leyla Urn | 116 |
| Madison Planters | 120 |
| Origami Planters | 124 |
| Orinoco Bowls | 126 |
| Pleat Planters | 132 |
| Ridge Planters | 134 |
| Step Planters | 136 |



Everyday Planters 138

| | |
|------------------------------------------------------|-----|
| Dylan Rectangular Planters | 140 |
| Emma Bowls / Hanging Planters | 142 |
| Emma Planters | 144 |
| Emma Nature Planters | 146 |
| NEW (+) Emma Circular Positive Planters | 150 |
| Emma Rectangular Planters | 152 |
| Emma Planters and Saucers Display | 154 |
| Eva Planters | 156 |
| Harvest Elevated Planter | 160 |



Mobility and Drainage Solutions 162

| | |
|------------------------------------------|-----|
| Pebble Plant Caddies | 166 |
| Universal Round and Square Saucers | 170 |
| Clear Saucers | 176 |
| Cork Mats | 180 |



Watering Cans and Sprayers 182

| | |
|-----------------------------------------|-----|
| Cleo Watering Can and Sprayers | 186 |
| Energy Sprayers and Watering Cans | 188 |
| Energy PRO Sprayers 360° | 190 |
| NEW Eos Watering Can | 192 |



Multiuse Bags 194

| | |
|----------------------|-----|
| Gabrielle Bags | 200 |
|----------------------|-----|

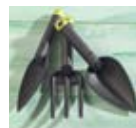

Tools and Metal Brackets 202

| | |
|------------------------------------------------|-----|
| Garden Tools | 206 |
| Adjustable Bracket Set for Rail Planters | 208 |



Marketing Aids 210

| | |
|-----------------------------------------|-----|
| Digital Opportunities | 212 |
| Garden Center Signage | 214 |
| Crescent Garden Display Platforms | 215 |
| Color Sample Pack | 215 |
| TruDrop POP Material | 215 |



Our Customer Promise

When Paula Douer and Harry Tchira created Crescent Garden in 1999, they were skilled in manufacturing and design, and while enthusiastic about gardening they weren't yet experts. They set about listening, learning, and discovering from industry friends and colleagues what's needed for gardens and gardeners to thrive. 25 years later, the Crescent Garden Company is a popular and progressive home and garden provider, bringing together a premier container gardening brand, a pioneer in self-watering and sustainable solutions. The company culture is powered by people who are professional, passionate and always in their customers' corner.

Lead brand Crescent Garden, trusted by contractors, designers, plant experts, independent garden centers and nurseries, offers containers and accessories distinguished by refined design and breakthrough innovation that lasts and lasts, for successful, inspired gardening.

Their pioneering TruDrop™ system engineers self-watering planters to go up to weeks without watering, for phenomenal results and more confident gardeners. TruDrop dramatically transforms the way people care for plants.

Crescent Too, available across garden centers, popular retailers and online, brings attractive and useful containers and supplies that make gardening easier and more rewarding to more people, at excellent value.

Crescent Garden believes that planters should work for you, not the other way around, and directs their R&D on design and innovation that pushes the envelope, legendary reliability and durability in whatever season, and understanding what works best for healthy plants and the people who love them.

With a vision to make gardening more accessible and relevant to everyone, while going beyond industry standards for what's possible, the Crescent Garden Company dedicates everything toward a simple customer promise:

we help you grow

CRESCENT *garden*

Crescent Garden planters are defined by their refined design and breakthrough innovation that lasts and lasts for successful, inspired gardening.



All encompassing TruDrop
One self-watering



Inspired solutions with
design in mind



Timeless design



Trend-setting style

Crescent**TOO**

Attractive and useful planters and supplies
that make gardening easier and more
rewarding for more people



Everyday planters
well-made



Versatile self-watering with
TruDrop Flex



Lightweight, durable tools



Solution driven accessories

At Crescent Garden, sustainability begins with a distinct sensibility — a circular, continuous approach for positive impact wherever we can make a difference. We look at everything in harmony, inside and out, over time.

Surrounding our products are processes and policies, for a holistic approach to lessening our own environmental footprint, which in turn can result in more climate-positive outcomes in our retailer and customer communities.

Whether it's internal ways of working, how we source, make and distribute, or how gardeners use, dispose, and recycle, we want to help everyone grow, more sustainably.

Centered on the lifecycle of our products

Our R&D lifecycle is circular from the outset: Materials / Manufacturing / Distribution / Customer Experience. Thoughtful resource use and innovations in product development, energy-efficient manufacturing, reducing our shipping carbon footprint, ecological emphasis in product use and advice, and responsible disposal and reuse. Good goes around.

Promoting green spaces in our facilities.

Our manufacturing facility in Colombia sits on a campus that invested heavily in adding trees and green spaces where there weren't any before, for improved carbon offset. Our new corporate headquarters that will open in 2025, is designed as a multi-use space with large green areas both indoors and outdoors that are designed as flexible work spaces both for us and open to the public.

Creating a paperless company

From our beginnings over 25 years ago, we envisioned a nature-centric company that would use technology to remain paperless. We have no file cabinets, and our team members work together on multiple, energy-efficient screens, integrating electronically with our vendors and customers. We continue to pioneer ways to work more resource-efficiently throughout.



DESIGN & PRODUCTION

- Responsible manufacturing is fundamental: efficient, safe, environment-conscious, and community-minded.
- Total Recycling approach reusing scrap and excess in our own facilities.
- Use of local, renewable suppliers when available.



100% MATERIALS

- Designed for continuous use – never ending the lifecycle.
- 100% recyclable across multiple lifecycles.
- Easily separated mixed materials.
- **Introducing** upcycled and bio-based innovations: **Circular Positive™** product ranges.



DISTRIBUTION

- Lightweight and unbreakable products that use less energy and packaging in transport.
- Ordering, production and shipping procedures to minimize resource consumption.



CONSUMER EXPERIENCE

- Using less water and fertilizer, a vital element in sustainable gardens.
- TruDrop self-watering planters collect rain and irrigation water for up to 50% savings.
- High durability. Most products supported by a 10 Yr Warranty.

Specifications on Product

| dimensions | | |
|--------------------|---------------------|---------------------|
| | | |
| 7.75 in 19.7 cm | 11.75 in 29.8 cm | 11.00 in 27.9 cm |

We have included inner and outer measurements as well as volume capacity for all our planters to make it easy when specifying a planter for a job.

| | dimensions | | | | volume capacity | planter ref.# | saucer ref.# |
|---------------------|---------------------|--------------------|---------------------|---------------------|--------------------|---------------|--------------|
| | | | | | | | |
| A Agave 18" Planter | 12.75 in 34.3 cm | 7.75 in 19.7 cm | 11.75 in 29.8 cm | 11.00 in 27.9 cm | 4.50 gal 15.8 l | A8800XX | A80000T |
| B Agave 18" Planter | 17.75 in 45.1 | 18.25 in 46.3 | 13.00 in 33.0 | 13.50 in 34.3 | 9.00 gal 34.1 | A8800XX | A80000T |
| Agave 24" Planter | 23.75 in 60.3 | 12.25 in 31.1 | 18.00 in 45.7 | 17.25 in 43.8 | 13.75 gal 51.7 | A8800XX | A80000T |

Identify the Logos



See the next page for more details.

Quick Ship



In-Stock colors and ready to ship.



CRESCENT
garden

87

Product Brand Identity

CRESCENT
garden

Crescent**TOO**

Identify the Logos



10 Year Warranty

Our 10 Year Warranty against fading, or cracking on our rotationally molded products gives confidence to consumers when purchasing our products.



Circular Positive™, **NEW!**

A circular, continuous approach for plant and planet: these planters are manufactured with an upcycled material made from landfill waste diverting harmful emissions for a more positive environmental impact.



TruDrop System

Our patented TruDrop self-watering delivers phenomenal results with little effort. See more details on page 18



Water Gardening

Easy to install and maintain, these containers are ideal to tap into the water gardening market. With a broad selection of shapes, depths and sizes, these containers can accommodate a variety of water gardening plants and fish. Some of our planters are also supplied with specialty plugs to use with fountain pumps.



No Drainage Holes

Healthy plants start with proper drainage. We design most of our planters with elevated pot feet and drainage holes that are adequately sized for each planter. However, there are times when consumers just need a cache pot or drainage can be an issue. In these case you will find the No Drainage Holes icon on the page.



Double Wall

Double Walled construction provides many benefits including superior structural integrity, enhanced appearance and insulating properties for better thermal protection of plant roots.



Can be Personalized

Some of our planters can be branded with a logo, house number or family name. See page 14.

Quick Ship Program and Special Orders

We provide a wide array of in stock items in our Quick Ship program that are readily available all year round. We consider these to be a selection of our best selling colors in each design and style. These can be viewed throughout the catalog in the individual shots provided on each page.

However, all of our Crescent Garden planters can also be customized in any of the colors below. Check with your customer service representative for lead times, pricing and terms on special orders.

Standard Colors:

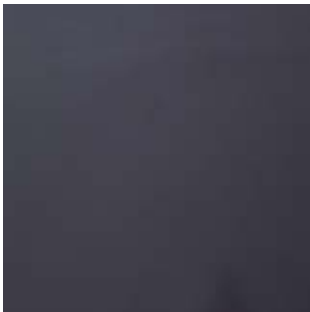

Caviar Black Ref: 94



Old Bronze Ref: 14



Mocha Ref: 44

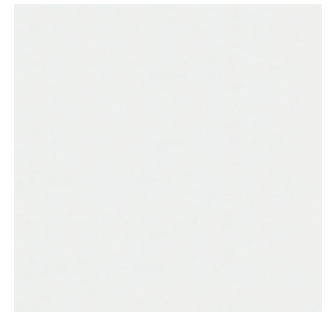

Cloud White Ref: 00



Rust Ref: 33



Weathered Terracotta Ref: 34



Weathered Concrete Ref: 92



Midnight Ref: 55



Olive Ref: 82

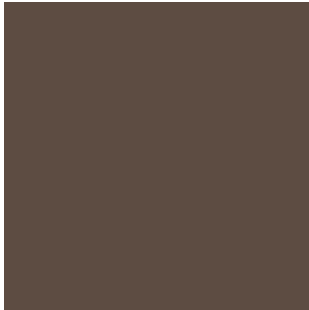

Bark Ref: 74



Currant Ref: 47



Ash Ref: 98



Slate Ref: 97



Parchment Ref: 11



Shadow Ref: 95

Can be Personalized

Make your next project unique by customizing the planters.

- Brand with hotel, city, healthcare facility or park name to delineate campuses and create greater awareness.
- Use for residential properties to identify street or house numbers.
- Create a custom family crest or display a family name to give an entrance a special touch.

Available Styles for Personalization



Pinch Planter



Rim Planter

Let's get started:

Image Requirements:

Vectorized graphic should be provided in any of the following file types: .ai, .eps, .dxf or .pdf. If providing pdf it should be created from a vectorized graphic.

Timeline for Customized Project:

Once images are received, we would provide artwork for approval within 4-5 working days. We would require signature approval on artwork. Once this is returned to us production lead time for Quick Ship items, can be between 4-5 weeks.

Minimums:

Contact us at customerservice@crescentgarden.com, for details on minimums and pricing for customized projects.







 TruDrop ONE



Weeks without Watering

With our TruDrop self-watering, containers can go without watering for 2-6 weeks depending on plant selection and climate.

Easy

With no rocks or wicks, this single-body planter just needs potting soil and plant making it easy even for first time gardeners.



Safe, Efficient

With 50% less water usage and more efficient use of fertilizers that remain in the water cavity, these planters are environmentally friendly.

Dramatically Successful

In our planters with TruDrop the plants determine how much water they need instead of the consumer which renders phenomenal results.

CRESCENT
garden

TruDrop ONE

Finally.
A planter that
works for you.



Easy



Safe



Success



Efficient



Versatile



Learn More

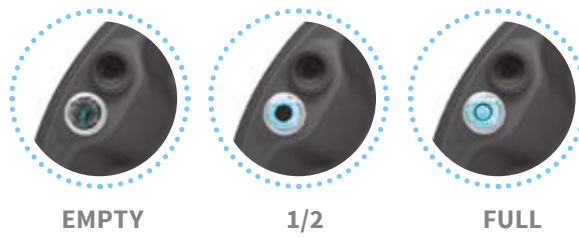

Water Level Indicator

Easy to read.

Easy To Fill Hole

Includes cap to avoid water contamination.

Double Wall Construction*

Large water reservoir allows plants to go longer without watering.

Mess Free Drain System

Optional quick connect coupling in larger planters facilitates draining planter without spillage.

Can connect directly to hose or pump.



Overfill Drain

When using outdoors, planter is designed to drain excess rain water.

Sealed Bottom

Plug included with planter for indoor use.

Capillary Action

Watering via roots creates healthy plants.



*Outdoor trials using a 20" (50,8 cm) planter have shown that plants **can go for up to 6 weeks without refilling.**

We never expected TruDropOne to change the way people garden but now we hear it from our clients.

“

“I returned home from **two weeks’ vacation...** and was very happy to see that my TruDrop planter did its job while I was away.”

Jed Laufferty, West Chester, Pennsylvania, U.S.A



“

“I think these are the **best** things since sliced bread lol.”

Jed Susan, Ontario, Canada

“

“They work great for me, as we live at a **lake home** with 6 outdoor pots and we are gone from our home several times a month for anywhere from a couple days to a week. With your pots, my flowers now make it through the summer without dying from lack of water.”

Debbie, Minnesota, U.S.A

“

“TruDrop’s claims that watering is only needed every two to six weeks sounded a little far-fetched, but... (It) works better than I ever imagined.”

Heather Rhoades, **Gardening Know How**

“

I got 26 days out of it... I **saved** that much **time** watering!

Laura LeBoutillier, **Garden Answer**, Oregon, U.S.A



“

“The pottery is **gorgeous** by the way! We have one very happy customer - can't wait to order more!”

Erin, **Landscape Solutions Company**, Tennessee, U.S.A



“

"We are a Boutique Resort in beautiful St. Croix, US Virgin Islands. For years we have searched for planters which could withstand our sun and sea elements and still have a classy and elegant presence. The planters are very easy to set up, plant and maintain. The guests continually compliment the elegance and beauty. We can not say enough about the quality of product and customer service."

Sand Castle on the Beach Hotel, Virgin Islands, U.S.A.

“

"Where we were once watering every day, we are now able to simply “top off” each planter once a week. The savings in manpower have been exponential."

Mark Russel (Director of Horticulture),
SeaWorld Parks and Entertainment
Orlando, U.S.A.



“

"They have sixteen Pinch in Lawrence. I wouldn't use anything else now for city planters it saves me a lot of watering time! I have 34 estate planters in the city next to Lawrence, Haverhill. I have to water those every third day. Not with the Pinch."

Steve Nunan - Massachussetts
Nunan's Florist and Greenhouse, U.S.A.



Crescent Garden: Design Ideas



Edibles in Small Spaces:
Our Nest planters are ideal to grow edibles even in spaces with no garden.



Step it up:
With the 14" width Mod planters it is easy to bring green to narrow spaces.



Midnight Blue:

A great replacement for black, Midnight will add elegance to any space.

Crescent Garden: Design Ideas



Commercial Applications:

With TruDrop a commercial space can be retrofitted with new planters without the investment of costly sub-irrigation installations.



RESTAURANT & BAR



Narrow and Tall:
Instead of traditional urns these curved Cup planters make elegant entryways.



Supersize:

When you have a door that is over 7 feet tall make sure you use a planter proportionate like the Rim 30".



Better Economics:

TruDrop self-watering allows properties to maintain planters at a fraction of the regular cost giving them flexibility to add green in more places.

Cup Tall Planters

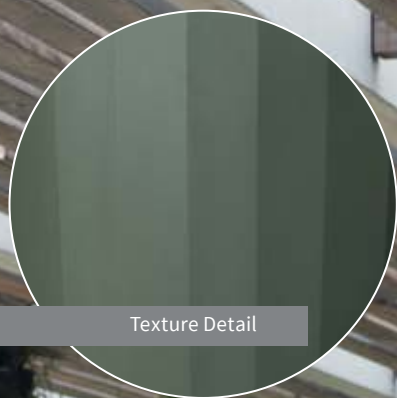

Texture Detail



Bark and Olive

|  | | dimensions | | | | volume capacity | | planter ref.# | saucer ref.# |
|----------------------------------------------------------------------------------|----------------------|---------------------|--------------------|------------------------------------|---------------------|--------------------|--------------------|---------------|--------------|
| | | soil | water | soil | water | | | | |
| A | Cup Tall 16" Planter | 15.75 in 40,0 cm | 9.61 in 24,4 cm | 11.58 / 11.02 in 29,4 / 28,4 cm | 29.53 in 75,0 cm | 6.16 gal 23,3 l | 3.17 gal 12,0 l | A6440XX | A9910XXT |
| B | Cup Tall 19" Planter | 18.70 47,5 | 11.22 28,5 | 14.53 / 14.96 36,9 / 38,0 | 34.65 88,0 | 11.29 42,7 | 5.65 21,4 | A6447XX | A9913XXT |
| C | Cup Tall 22" Planter | 21.65 55,0 | 12.99 33,0 | 17.48 / 19.23 44,4 / 48,8 | 39.37 100,0 | 19.15 72,5 | 8.32 31,5 | A6455XX | A9915XXT |

Make sure to order mess-free drain couplings if you will be emptying water cavity on a delicate surface. See page 63.



IN-STOCK QUICK SHIP COLORS



Caviar Black Ref: 94



Cloud White Ref: 00



Ash Ref: 98



Slate Ref: 97



Midnight Ref: 55



Olive Ref: 82



Bark Ref: 74

* 10 Year Limited Warranty covers planter shell only.

Dot Planters



Texture Detail



Cloud White

|  | | dimensions | | | | volume capacity | | planter ref.# | saucer ref.# |
|----------------------------------------------------------------------------------|-------------------|---------------------|--------------------|-----------------------------------|---------------------|--------------------|-------------------|---------------|--------------|
| | | | | | | soil | water | | |
| A | Dot 16" Planter** | 16.00 in 40,6 cm | 9.80 in 24,9 cm | 12.80 / 6.90 in 32,5 / 17,5 cm | 16.00 in 40,6 cm | 3.59 gal 13,6 l | 2.14 gal 8,1 l | A5940XX | A9910XXT |
| B | Dot 20" Planter | 20.00 50,8 | 12.28 31,2 | 16.21 / 9.45 41,2 / 24,0 | 20.04 50,9 | 7.36 27,9 | 5.42 20,5 | A5950XX | A9913XXT |
| C | Dot 26" Planter | 26.00 66,0 | 15.96 40,5 | 22.21 / 12.00 56,4 / 30,5 | 26.04 66,1 | 19.59 74,2 | 12.8 48,5 | A5965XX | A9918XXT |

Make sure to order mess-free drain couplings if you will be emptying water cavity on a delicate surface. See page 63.



IN-STOCK QUICK SHIP COLORS



Old Bronze Ref: 14



Caviar Black Ref: 94



Cloud White Ref: 00



Mocha Ref: 44



Midnight Ref: 55



Ash Ref: 98



Slate Ref: 97

* 10 Year Limited Warranty covers planter shell only.

** This size does not include a side drain and cannot accommodate a mess free drainage system.

Mod Family of Planters





Mod Family of Planters

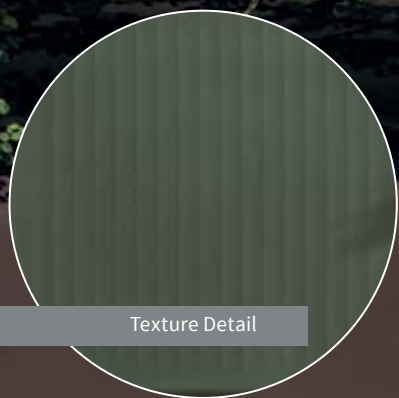

Texture Detail

RESTAURANT & BAR



Cloud White, Ash and Olive

| Planters in 20" (51 cm) width Planters in 14" (36 cm) width | | dimensions | | | volume capacity | | planter ref.# |
|----------------------------------------------------------------|------------------------------------------|----------------------------------|---------------------------------------------------|---------------------|--------------------|--------------------|---------------|
| | | | | | soil | water | |
| | | | | | | | |
| A | Mod Low Square 20" x 20" x 16"H | 19.7 x 19.7 in 50,0 x 50,0 cm | 14.96 x 15.35 / 14.76 in 38,0 x 39,0 / 37,5 cm | 15.75 in 40,0 cm | 8.85 gal 33,5 l | 7.93 gal 30,0 l | A6140XX |
| B | Mod Large Trough 40" x 20" x 20"H | 39.3 x 19.7 99,8 x 50,0 | 35.04 x 15.75 / 18.70 89,0 x 40,0 / 47,5 | 19.69 50,0 | 26.95 102,0 | 19.55 74,0 | A6150XX |
| C | Mod Tall Square 20" x 20" x 38"H | 19.7 x 19.7 50,0 x 50,0 | 14.96 x 14.96 / 37.40 38,0 x 38,0 / 95,0 | 38.19 97,0 | 19.55 74,0 | 15.85 60,0 | A6197XX |
| D | Mod 20" Tall and Narrow 20" x 14" x 24"H | 19.7 x 13.8 50,0 x 35,1 | 14.96 x 9.06 / 16.34 38,0 x 23,0 / 41,5 | 23.62 60,0 | 5.34 20,2 | 12.63 47,8 | A6160XX |
| E | Mod 40" Tall and Narrow 40" x 14" x 30"H | 39.3 x 13.8 99,8 x 35,1 | 33.07 x 9.06 / 28.35 84,0 x 23,0 / 72,0 | 29.53 75,0 | 22.72 86,0 | 19.94 75,5 | A6175XX |
| F | Mod Mini Trough 20" x 14" x 12"H ** | 19.7 x 13.8 50,0 x 35,1 | 14.96 x 9.06 / 11.02 38,0 x 23,0 / 28,0 | 11.81 30,0 | 4.20 15,9 | 3.34 12,6 | A6130XX |

Make sure to order mess-free drain couplings if you will be emptying water cavity on a delicate surface. See page 63.

*



IN-STOCK QUICK SHIP COLORS



Caviar Black Ref: 94



Cloud White Ref: 00



Ash Ref: 98



Slate Ref: 97



Midnight Ref: 55



Olive Ref: 82



Bark Ref: 74

* 10 Year Limited Warranty covers planter shell only.

** This size does not include a side drain and cannot accommodate a mess free drainage system.

Six different sizes.
Move them, stack them,
and create your own space.



Mod planters in 20 in (51 cm) width



Mod planters in 14 in (36 cm) width

Mod planters maximum stack is 2 planters only.



Mod planters with 20 in (51 cm) width



Mod Low Square
20" x 20" x 16"H
A6140XX

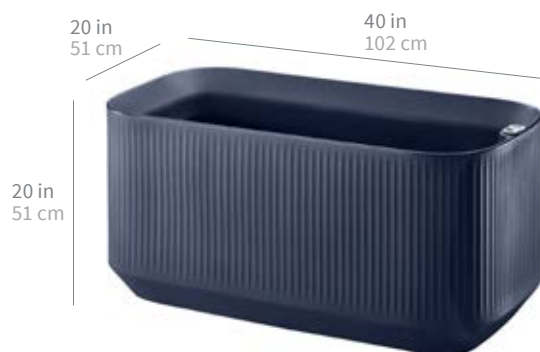

Mod Large Trough
40" x 20" x 20"H
A6150XX



Mod Tall Square
20" x 20" x 38"H
A6197XX

Mod planters with 14 in (36 cm) width

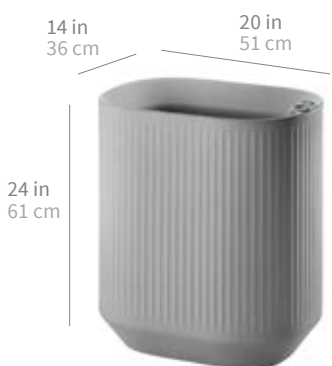

Mod 20" Tall and Narrow
20" x 14" x 24"H
A6160XX

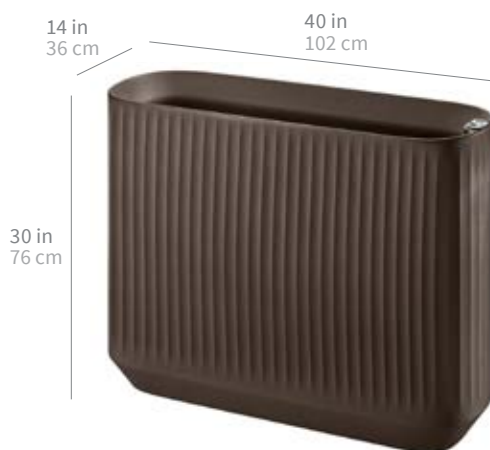

Mod 40" Tall and Narrow
40" x 14" x 30"H
A6175XX

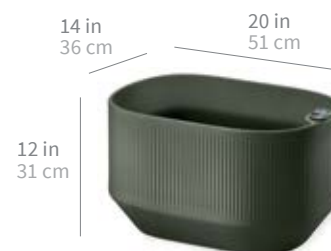

Mod Mini Trough
20" x 14" x 12"H
A6130XX

Nest Planters



Cloud White



Cloud White



Cloud White



Bark



Slate and Olive in back







Nest Planters



Texture Detail

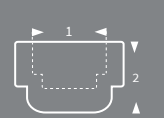

Slate and Olive in back

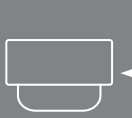
|  | | dimensions | | | soil volume capacity | water volume capacity | planter ref.# |
|----------------------------------------------------------------------------------|-------------------------------|-----------------------------------------------------------------------------------|-----------------------------------------------------------------------------------|------------------------------------------------------------------------------------|-------------------------------------------------------------------------------------|-------------------------------------------------------------------------------------|-------------------------------------------------------------------------------------|
| | |  |  |  |  |  |  |
| A | Nest 18" x 36" Raised Planter | 18.00 x 36.00 in 45,7 x 91,4 cm | 13.03 x 31.34 / 9.05 in 33,1 x 79,6 / 23,0 cm | 16.00 in 40,6 cm | 13.21 gal 50,0 l | 6.67 gal 25,2 l | A6249XX |
| B | Nest 22" x 44" Raised Planter | 22.00 x 44.00 in 55,9 x 111,8 cm | 17.22 x 39.27 / 9.05 in 43,7 x 99,7 / 23,0 cm | 16.00 in 40,6 cm | 22.80 gal 86,3 l | 12.25 gal 46,4 l | A6251XX |
| C | Nest 30" x 48" Raised Planter | 30.00 x 48.00 in 76,2 x 121,9 cm | 25.24 x 42.96 / 9.06 in 64,1 x 109,1 / 23,0 cm | 16.00 in 40,6 cm | 40.15 gal 152,0 l | 18.49 gal 70,0 l | A6271XX |

Make sure to order mess-free drain couplings if you will be emptying water cavity on a delicate surface. See page 63.

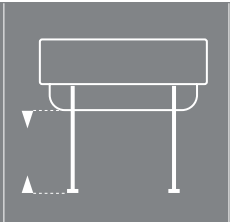
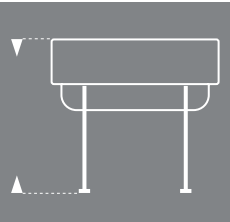
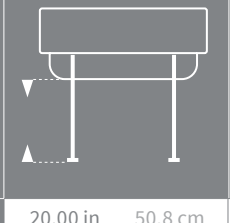
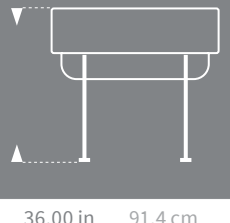
| Nest Height with Legs | | | |
|-----------------------------------------------------------------------------------|-----------------------------------------------------------------------------------|-----------------------------------------------------------------------------------|-----------------------------------------------------------------------------------|
|  |  |  |  |
| A, B, C | 20.00 in 50,8 cm | 36.00 in 91,4 cm | |



IN-STOCK QUICK SHIP COLORS



Cloud White Ref: 00



Weathered Terracotta Ref: 34



Slate Ref: 97



Midnight Ref: 55



Olive Ref: 82



Bark Ref: 74

* 10 Year Limited Warranty covers planter shell only.



| | | dimensions | | | | product ref.# |
|---|---------------------------------------------------------------------|-------------------------------|----------|---------------|----------|---------------|
| | | Width | | Height | | |
| A | Trellis for 18" Nest Raised Planter | 17.60 44,7 | in cm | 28.00 71,1 | in cm | AZ631894 |
| | Trellis for 22" Nest Raised Planter | 22.00 55,9 | | 28.00 71,1 | | AZ632294 |
| | Trellis for 30" Nest Raised Planter | 29.80 75,7 | | 28.00 71,1 | | AZ633094 |
| B | Greenhouse Cover for 18" Nest Raised Planter (includes storage bag) | 18.20 x 36.50 46,2 x 92,7 | | 26.40 67,1 | | AZ641800 |
| | Greenhouse Cover for 22" Nest Raised Planter (includes storage bag) | 22.70 x 44.70 57,7 x 113,5 | | 26.40 67,1 | | AZ642200 |
| | Greenhouse Cover for 30" Nest Raised Planter (includes storage bag) | 30.50 x 48.20 77,5 x 122,4 | | 26.40 67,1 | | AZ643000 |
| C | Hooks for Nest Raised Planter (Bag of 2) | 3.00 7,6 | | 3.50 8,9 | | AZ670094C |

A - Trellis for Nest Raised Planter



B - Greenhouse Cover for Nest Raised Planter



C - Hook for Nest Raised Planter



Pinch Planters







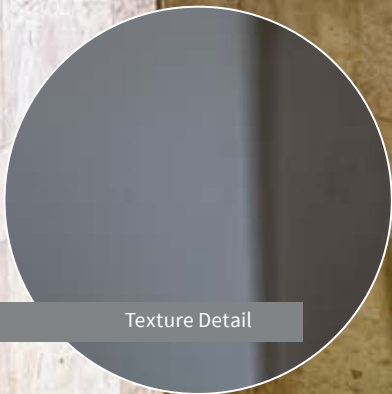



Pinch Planters

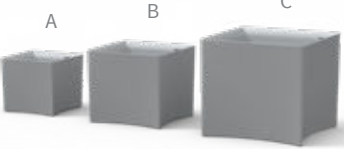

Texture Detail



Slate

|  | | dimensions | | | soil volume capacity | water volume capacity | planter ref.# |
|-----------------------------------------------------------------------------------|-------------------|-----------------------------------------------------------------------------------|-----------------------------------------------------------------------------------|------------------------------------------------------------------------------------|-------------------------------------------------------------------------------------|-------------------------------------------------------------------------------------|-------------------------------------------------------------------------------------|
| | |  |  |  |  |  |  |
| A | Pinch 23" Planter | 22.52 in 57,2 cm | 21.85 x 19.69 / 10.04 in 55,5 x 50,5 / 25,2 cm | 20.28 in 51,5 cm | 11.73 gal 44,4 l | 9.91 gal 37,5 l | A6757XX |
| B | Pinch 29" Planter | 28.98 73,6 | 28.35 x 26.38 / 12.60 72,0 x 67,0 / 32,0 | 26.06 66,2 | 26.95 102,0 | 24.57 93,0 | A6774XX |
| C | Pinch 37" Planter | 36.93 93,8 | 36.30 x 34.65 / 15.75 92,2 x 88,0 / 40,0 | 33.27 84,5 | 60.76 230,0 | 55.48 210,0 | A6794XX |

Make sure to order mess-free drain couplings if you will be emptying water cavity on a delicate surface. See page 63.



IN-STOCK QUICK SHIP COLORS



Caviar Black Ref: 94



Cloud White Ref: 00



Ash Ref: 98



Slate Ref: 97



Midnight Ref: 55



Olive Ref: 82



Bark Ref: 74

* 10 Year Limited Warranty covers planter shell only.

Rim Planters













Rim Planters

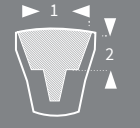

Texture Detail



|  | | dimensions | | | | soil volume capacity | water volume capacity | planter ref.# | saucer ref.# |
|----------------------------------------------------------------------------------|-------------------|-----------------------------------------------------------------------------------|-----------------------------------------------------------------------------------|-----------------------------------------------------------------------------------|------------------------------------------------------------------------------------|-------------------------------------------------------------------------------------|-------------------------------------------------------------------------------------|-------------------------------------------------------------------------------------|-------------------------------------------------------------------------------------|
| | |  |  |  |  |  |  |  |  |
| A | Rim 18" Planter** | 17.70 in 45,0 cm | 9.84 in 25,0 cm | 13.00 / 8.86 in 33,0 / 22,5 cm | 17.91 in 45,5 cm | 5.14 gal 19,5 l | 3.92 gal 14,8 l | A6045XX | A9910XXT |
| B | Rim 22" Planter | 21.60 54,9 | 12.60 32,0 | 17.00 / 10.83 43,2 / 27,5 | 21.85 55,5 | 9.95 37,7 | 7.32 27,7 | A6055XX | A9913XXT |
| C | Rim 26" Planter | 25.60 65,0 | 14.96 38,0 | 21.00 / 12.80 53,3 / 32,5 | 25.79 65,5 | 17.73 67,1 | 11.86 44,9 | A6065XX | A9915XXT |
| D | Rim 30" Planter | 29.60 75,2 | 17.71 45,0 | 25.00 / 14.76 63,5 / 37,5 | 29.72 75,5 | 27.94 105,8 | 19.91 75,4 | A6075XX | A9990XXT |

Make sure to order mess-free drain couplings if you will be emptying water cavity on a delicate surface. See page 63.



IN-STOCK QUICK SHIP COLORS



Old Bronze Ref: 14



Caviar Black Ref: 94



Cloud White Ref: 00



Weathered Terracotta Ref: 34



Ash Ref: 98



Slate Ref: 97



Midnight Ref: 55



Olive Ref: 82



Bark Ref: 74



Currant Ref: 47

* 10 Year Limited Warranty covers planter shell only.

** This size does not include a side drain and cannot accommodate a mess free drainage system.

Slat of Planters

NEW



Slate



Slate



Slat of Planters

NEW



Caviar Black



Slat Planter Boxes

NEW

Texture Detail



Caviar Black

| | A B C | dimensions | | | volume capacity | | planter ref.# |
|---|-----------------------------------------------|------------------------------------|------------------------------------|---------------------|---------------------|---------------------|---------------|
| | | soil | water | | | | |
| A | Slat Square 22" Planter | 22.48 x 22.48 in 57,1 x 57,1 cm | 17.72 / 12.20 in 45,0 / 31,0 cm | 19.69 in 50,0 cm | 14.66 gal 55,5 l | 10.30 gal 39,0 l | A8157XX |
| B | Slat Medium Deck Box 36" x 17" x 17"H Planter | 35.87 x 17.95 91,1 x 45,6 | 31.18 / 9.09 79,2 / 23,1 | 16.54 42,0 | 15,59 59,0 | 11.36 43,0 | A8191XX |
| C | Slat Large Deck Box 47" x 19" x 23"H Planter | 46.65 x 19.09 118,5 x 48,5 | 41.89 / 15.35 106,4 / 39,0 | 22.83 58,0 | 35.53 134,5 | 17.38 65,8 | A81118XX |

Make sure to order mess-free drain couplings if you will be emptying water cavity on a delicate surface. See page 63.

Caster Plates Size Small and Anti-Theft Bracket systems available - Page 60



Caster Plates:
Order 1 unit for Small and 2 units for Medium and Large Planters.



IN-STOCK QUICK SHIP COLORS



Caviar Black Ref: 94

NEW



Shadow Ref: 95

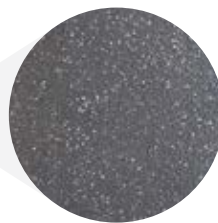

Slate Ref: 97

NEW



Parchment Ref: 11

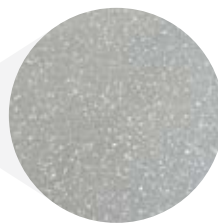

* 10 Year Limited Warranty covers planter shell only.

Slat Window Boxes

NEW

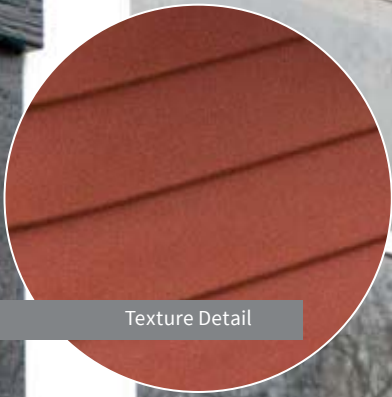

Texture Detail



Currant

| | A B C | dimensions | | | volume capacity | | planter ref.# |
|---|---------------------------------------------------------------------------------------------------------------------------------|------------------------------------|-----------------------------------|---------------------|--------------------|--------------------|---------------|
| | | soil | water | | | | |
| A | Slat Small Window Box 23" x 13" x 12"H Planter | 23.07 x 12.60 in 58,6 x 32,0 cm | 18.70 / 6.69 in 47,5 / 17,0 cm | 11.81 in 30,0 cm | 4.76 gal 18,0 l | 3.88 gal 14,7 l | A8258XX |
| B | Slat Medium Window Box 35" x 13" x 12"H Planter | 34.88 x 12.60 88,6 x 32,0 | 30.51 / 6.69 77,5 / 17,0 | 11.81 30,0 | 7.93 30,0 | 5.81 22,7 | A8288XX |
| C | Slat Large Window Box 47" x 13" x 12"H Planter | 46.69 x 12.60 118,6 x 32,0 | 42.32 / 6.69 107,5 / 17,0 | 11.81 30,0 | 11.20 42,4 | 7.93 30,0 | A82118XX |
| D | Metal Bracket for wall mounting Slat Window Boxes (Order 2 units for Small and Medium window box, order 3 for Large.) | 10.14 x 0.79 25,8 x 2,0 | N/A | 11.81 30,3 | N/A | N/A | AR07 |

Make sure to order mess-free drain couplings if you will be emptying water cavity on a delicate surface. See page 63.



IN-STOCK QUICK SHIP COLORS



Caviar Black Ref: 94



Cloud White Ref: 00



Slate Ref: 97

NEW



Shadow Ref: 95



Midnight Ref: 55



Olive Ref: 82







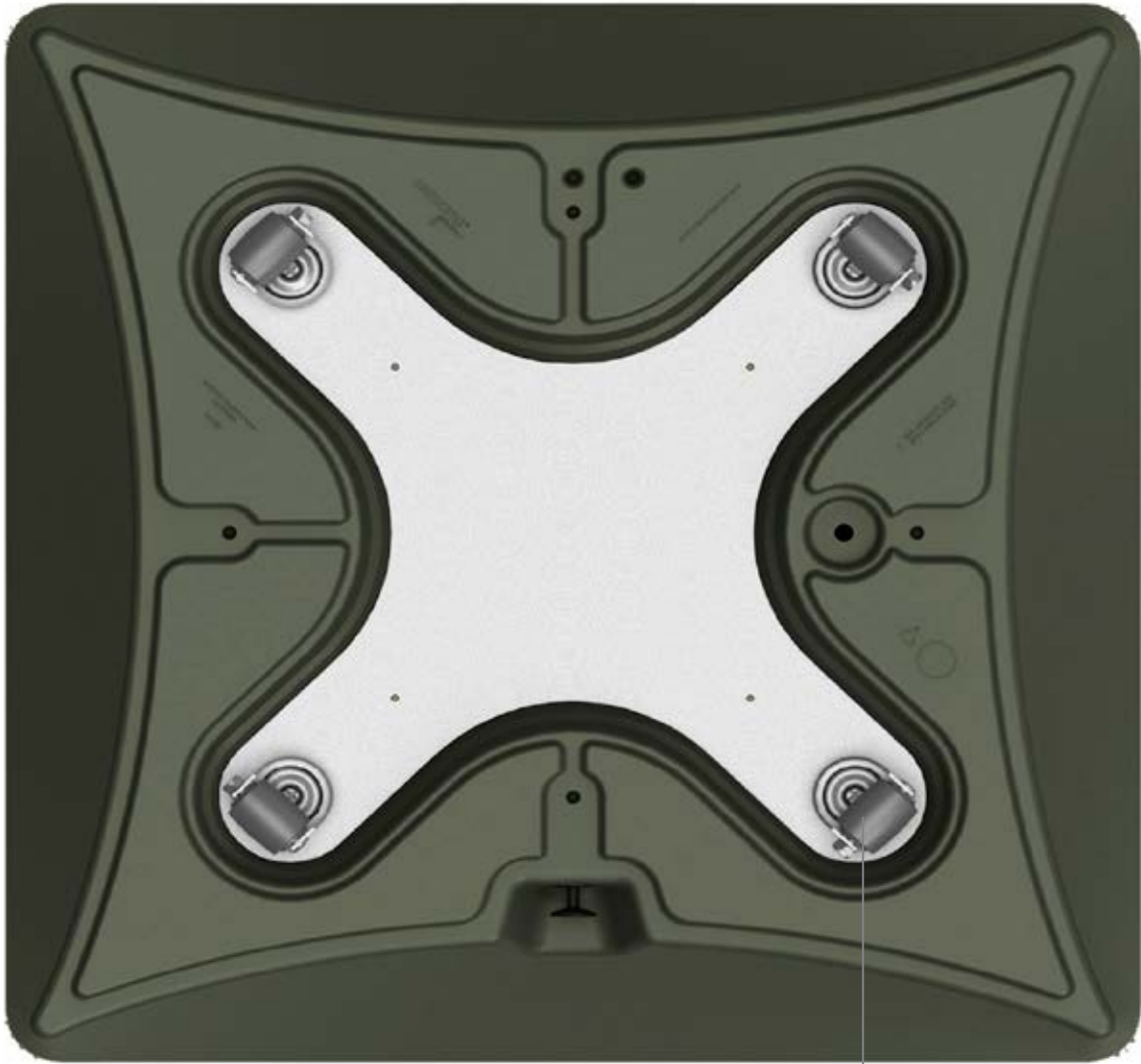







Currant Ref: 47

* 10 Year Limited Warranty covers planter shell only.



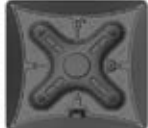

Rotating, recessed caster base
can be added for mobility.

| | | | | | |
|---------------------------------------------------------------------------------------|------------------------------------------------------------------------------------|----------|-------------------------------------------------------------------------------------|----------|------------------|
|  A | dimensions | | | | product ref.# |
| |  | |  | | |
| Caster System S - for 23" Pinch Planter or Slat Planter Boxes | 13.50 45,8 | in cm | 13.50 45,8 | in cm | AR03 |
| Caster System M - for 29" Pinch Planter | 24.02 61,0 | | 24.02 61,0 | | AR04 |
| Caster System L - for 37" Pinch Planter | 33.50 85,1 | | 33.50 85,1 | | AR05 |

| Caster System | Slat Planter Boxes | | | Pinch Planters | | |
|-------------------------------------------------------------------------------------|-----------------------------------------------------------------------------------|-----------------------------------------------------------------------------------|-----------------------------------------------------------------------------------|------------------------------------------------------------------------------------|-------------------------------------------------------------------------------------|-------------------------------------------------------------------------------------|
| | Square 22" | Medium Deck Box | Large Deck Box | 23" Pinch | 29" Pinch | 37" Pinch |
| |  |  |  |  |  |  |
|  | x1 | x2 | x2 | x1 | - | - |
|  | - | - | - | - | x1 | - |
|  | - | - | - | - | - | x1 |

TruDrop One - Add-ons for Pinch Planters and Slat Planter Boxes

| | | | | | |
|----------------------------------------------------------------------------------------|------------------------------------------------------------------------------------|----------|-------------------------------------------------------------------------------------|----------|---------------|
|  | dimensions | | | | product ref.# |
| |  | |  | | |
| A Anti-Theft Brackets System for Pinch Planter or Slat Planter Boxes (Set of 4) | 4.64 11,8 | in cm | 1.10 2,8 | in cm | AR06K1 |

Anti-theft brackets can be added to attach planter to concrete where needed.

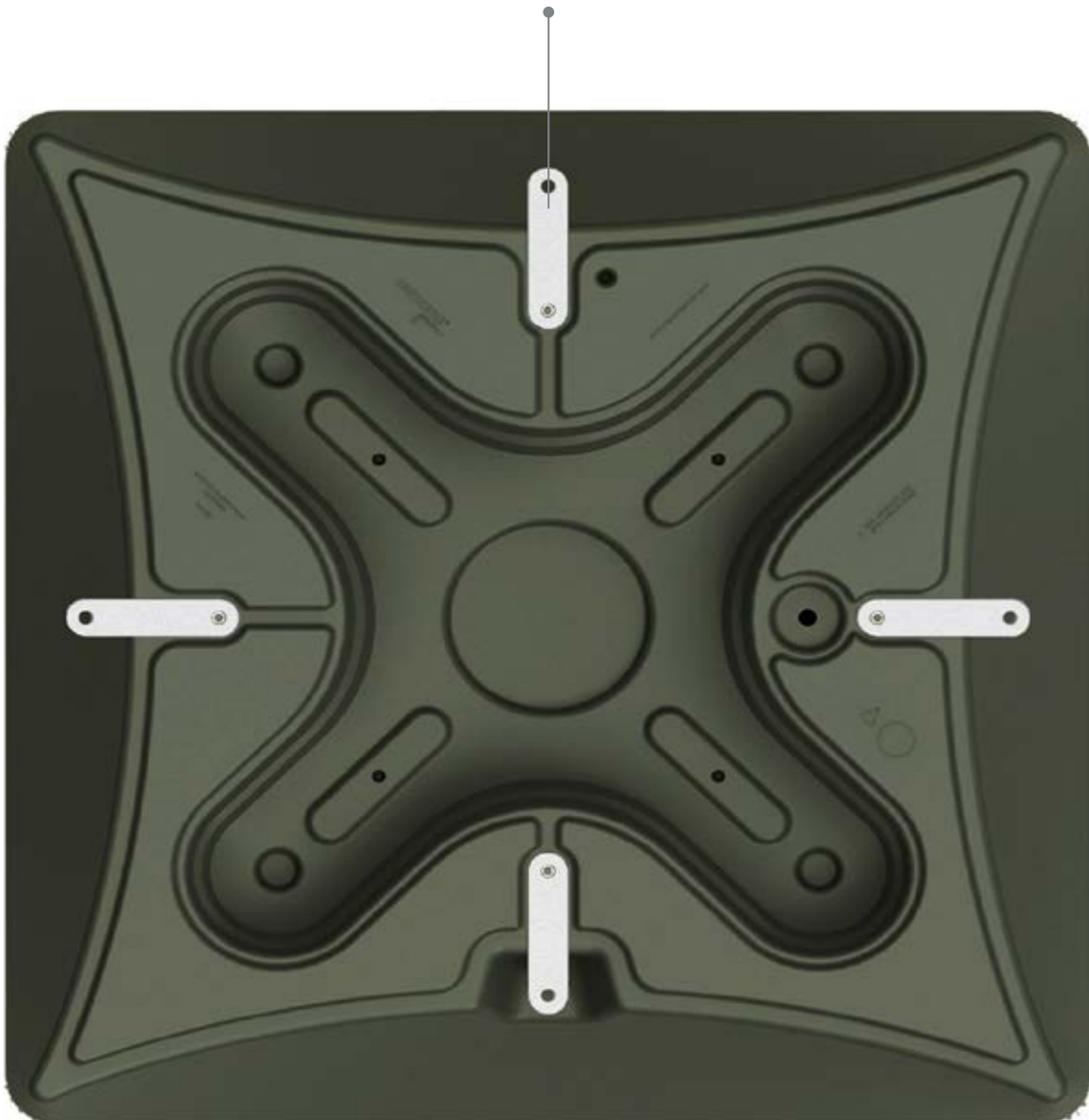

TruDrop One - Easy Drain System



| | description | product ref.# |
|---|-------------------------------------------|---------------|
| A | Coupler for use with any easy drain plug | AZ600588 |
| B | Easy Drain barbed pull drain plug | BT002P193 |
| C | Easy Drain Screw Plug for Legacy Planters | AZ607588 |

Make sure to order mess-free drain couplings if you will be emptying water cavity on a delicate surface.

How easy drain works

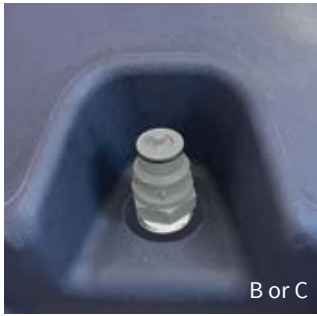

B or C

Replace the standard cap on the mouse hole opening at the bottom of the planter with the Easy Drain Screw cap or barbed pull drain cap depending on the planter selected.

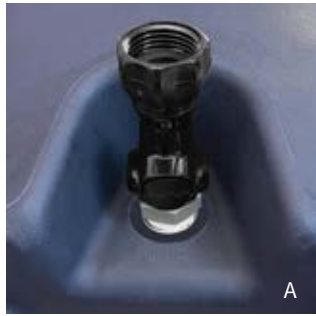

A

When you are ready to drain the planter just use the coupler to connect to a standard garden hose. Hose can then be directed to a bucket or a green area away from decks or delicate floors.



Replacement Parts for TruDrop One Planters





| description | A - indicator ref. # | B - NEW indicator ref. # |
|-------------|----------------------|--------------------------|
|-------------|----------------------|--------------------------|

| description | A - indicator ref. # | B - NEW indicator ref. # |
|-------------------------------------------------------------------------------------|----------------------|--------------------------|
| TruDrop One Water Level Indicator | | |
| TruDrop One Water Level Indicator for Cup 16" Planter | T01288188S | BT01742547 |
| TruDrop One Water Level Indicator for Cup 19" Planter | T01339244S | BT01872635 |
| TruDrop One Water Level Indicator for Cup 22" Planter | T01386287S | BT01994677 |
| TruDrop One Water Level Indicator for Dot 16" Planter | T01152086S | BT01384251 |
| TruDrop One Water Level Indicator for Dot 20" Planter | N/A | BT01485326 |
| TruDrop One Water Level Indicator for Dot 26" Planter | N/A | BT01642424 |
| TruDrop One Water Level Indicator for Mod 20" x 20" x 38"H Planter | T01375287S | BT01960770 |
| TruDrop One Water Level Indicator for Mod 20" x 14" x 12" Planter | T01110059S | BT01290234 |
| TruDrop One Water Level Indicator for Mod 20" x 14" x 24" Planter | T01228103S | BT01587310 |
| TruDrop One Water Level Indicator for Mod 20" x 20" x 16" Planter | T01149093S | BT01380310 |
| TruDrop One Water Level Indicator for Mod 40" x 14" x 30"H Planter | T01287191S | BT01732594 |
| TruDrop One Water Level Indicator for Mod 40" x 20" x 20" Planter | T01189131S | BT01485395 |
| TruDrop One Water Level Indicator for Small and Medium Nest | N/A | BT01389326 |
| TruDrop One Water Level Indicator for Rim 18" Planter | N/A | BT01447326 |
| TruDrop One Water Level Indicator for Rim 22" Planter | N/A | BT01537364 |
| TruDrop One Water Level Indicator for Rim 26" Planter | N/A | BT01640435 |
| TruDrop One Water Level Indicator for Rim 30" Planter | N/A | BT01742472 |
| TruDrop One Water Level Indicator for Slat Square 22" Planter | N/A | BT01481391 |
| TruDrop One Water Level Indicator for Slat Medium Deck Box 36" x 17" x 17"H Planter | N/A | BT01403322 |
| TruDrop One Water Level Indicator for Slat Large Deck Box 47" x 19" x 23"H Planter | N/A | BT01558463 |
| TruDrop One Water Level Indicator for Slat Window Box (Small, Medium and Large) | N/A | BT01282223 |
| TruDrop One Water Level Indicator for Pinch 23" Planter | N/A | BT01502326 |
| TruDrop One Water Level Indicator for Pinch 29" Planter | N/A | BT01647484 |
| TruDrop One Water Level Indicator for Pinch 37" Planter | N/A | BT01834655 |

| description | product ref.# |
|-------------|---------------|
|-------------|---------------|

| Leg Sets for Small Nest | |
|-------------------------|----------------------------------------|
| C | Leg Sets for Small Nest (Replacement) |
| C | Leg Sets for Medium Nest (Replacement) |
| C | Leg Sets for Large Nest (Replacement) |

| Water Caps and Plugs | |
|----------------------|---------------------------------------------------------------------|
| D | Replacement Water Cap intake |
| E | Replacement White Drain Cap |
| F | Replacement Red Plug for Overflow Drain |
| G | TruDrop Pouch with Replacement Drain plug, rubber insert & red plug |



Crescent**TOO**

 **TruDrop**FLEX



New Circular Positive ™

Our TruDrop Flex planters are now made with climate-positive UBQ materials, upcycled from landfill waste, diverting harmful emissions for a positive environmental impact.

Mix and Match

Complete flexibility from grower, to garden center, to consumer. Plants can be grown in insert and covers selected to reflect desired style.

Optional TruDrop Self Watering

Purchase with insert to go weeks without watering for phenomenal results and successful gardening.

Value Solution

Single wall planters can be used on their own or with TruDrop self watering insert. Accessible to everyone.



made with **ubaq**™



Introducing
Crescent**TOO**⁺

The **first** planter **of its kind**
made with **climate-positive** UBQ™ Material
for a **planet-positive** impact

The
Circular

Positive +
Planter

PRODUCTION AND LIFECYCLE

Upcycled from waste
Reduces landfill and emissions
Re-recyclable planters

IMPACT ON SUSTAINABILITY

Material **reduces** harmful emissions
Plant-positive containers & inserts
For a **Planet-Positive** environment

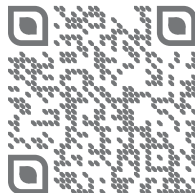

Learn More

Mix and Match

Crescent **TOO** | © TruDrop **FLEX**



Find a program that works for you.



Grab and Go Containers:

Grow in nursery, display in garden center. Allow consumer to customize with their style in mind.



Build your Own:

Allow consumers to make their own TruDrop Flex self-watering container by purchasing cover and inserts in the store.



10 Year Warranty Planters:

Offer covers as stand alone containers at a great value.

Fold Planters

NOW
Sold Individually

Sleek and Simple:
Our understated Fold planter will work
in any environment.



Optional Insert:
Up to weeks without watering for
great results: TruDrop Flex.

Fold Planters



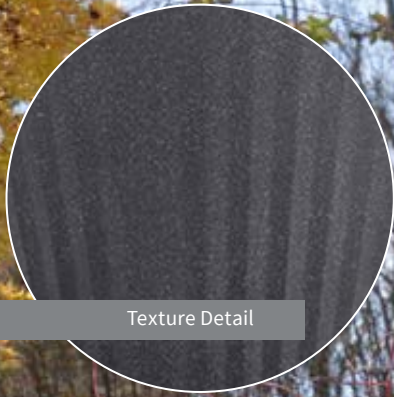



NOW
Sold Individually



Texture Detail



Bedrock Circular+

|  | | dimensions | | | | | | volume capacity | | planter ref.# |
|-----------------------------------------------------------------------------------|---------------------------|-----------------------------------------------------------------------------------|----------|-----------------------------------------------------------------------------------|----------|------------------------------------------------------------------------------------|----------|-------------------------------------------------------------------------------------|----------|-------------------------------------------------------------------------------------|
| | |  | |  | |  | |  | |  |
| A | Fold 15" Planter (Small) | 14.96 38,0 | in cm | 9.37 23,8 | in cm | 13.58 34,5 | in cm | 6.08 23,0 | gal l | B09015MXXX |
| B | Fold 18" Planter (Medium) | 18.11 46,0 | | 9.45 24,0 | | 16.69 42,4 | | 10.88 41,2 | | B09018MXXX |
| C | Fold 22" Planter (Large) | 22.05 56,0 | | 13.39 34,0 | | 19.88 50,5 | | 19.55 74,0 | | B09022MXXX |

Add TruDrop Flex insert for self-watering alternative. Page 83



IN-STOCK QUICK SHIP COLORS



Autumn Circular+ Ref: U33



Bedrock Circular+ Ref: U93



Juniper Circular+ Ref: U60



Coal Circular+ Ref: U94

Ridge Planters





NOW
Sold Individually



Texture Detail



Autumn Circular+

|  | | dimensions | | | | | | volume capacity | planter ref.# | |
|-----------------------------------------------------------------------------------|----------------------------|-----------------------------------------------------------------------------------|----------|-----------------------------------------------------------------------------------|----------|------------------------------------------------------------------------------------|----------|-----------------|---------------|-------------------------------------------------------------------------------------|
| | |  | |  | |  | | | |  |
| A | Ridge 15" Planter (Small) | 14.96 38,0 | in cm | 8.86 22,5 | in cm | 13.58 34,5 | in cm | 5.55 21,0 | gal l | B08815MXXX |
| B | Ridge 18" Planter (Medium) | 18.11 46,0 | | 9.45 24,0 | | 16.69 42,4 | | 10.30 39,0 | | B08818MXXX |
| C | Ridge 22" Planter (Large) | 22.05 56,0 | | 12.52 31,8 | | 19.88 50,5 | | 18.49 70,0 | | B08822MXXX |

Add TruDrop Flex insert for self-watering alternative. Page 83



IN-STOCK QUICK SHIP COLORS



Autumn Circular+ Ref: U33



Bedrock Circular+ Ref: U93



Juniper Circular+ Ref: U60



Coal Circular+ Ref: U94

Step Planters

NOW
Sold Individually



Step into a New Age:
Inspired by mid-century design, our Step
planters are a hit with young gardeners.







Step Planters

NOW
Sold Individually

Texture Detail

Bedrock Circular+



|  | | dimensions | | | | | | volume capacity | planter ref.# | |
|-----------------------------------------------------------------------------------|---------------------------|-----------------------------------------------------------------------------------|----------|-----------------------------------------------------------------------------------|----------|------------------------------------------------------------------------------------|----------|-----------------|---------------|-------------------------------------------------------------------------------------|
| | |  | |  | |  | | | |  |
| A | Step 15" Planter (Small) | 14.96 38,0 | in cm | 8.86 22,5 | in cm | 13.58 34,5 | in cm | 6.08 23,0 | gal l | B08915MXXX |
| B | Step 18" Planter (Medium) | 18.11 46,0 | | 9.45 24,0 | | 16.69 42,4 | | 11.10 42,0 | | B08918MXXX |
| C | Step 22" Planter (Large) | 22.05 56,0 | | 12.87 32,7 | | 19.88 50,5 | | 19.81 75,0 | | B08922MXXX |

Add TruDrop Flex insert for self-watering alternative. Page 83



IN-STOCK QUICK SHIP COLORS



Autumn Circular+ Ref: U33



Bedrock Circular+ Ref: U93



Juniper Circular+ Ref: U60



Coal Circular+ Ref: U94

TruDrop Flex - Insert and Water Gauge





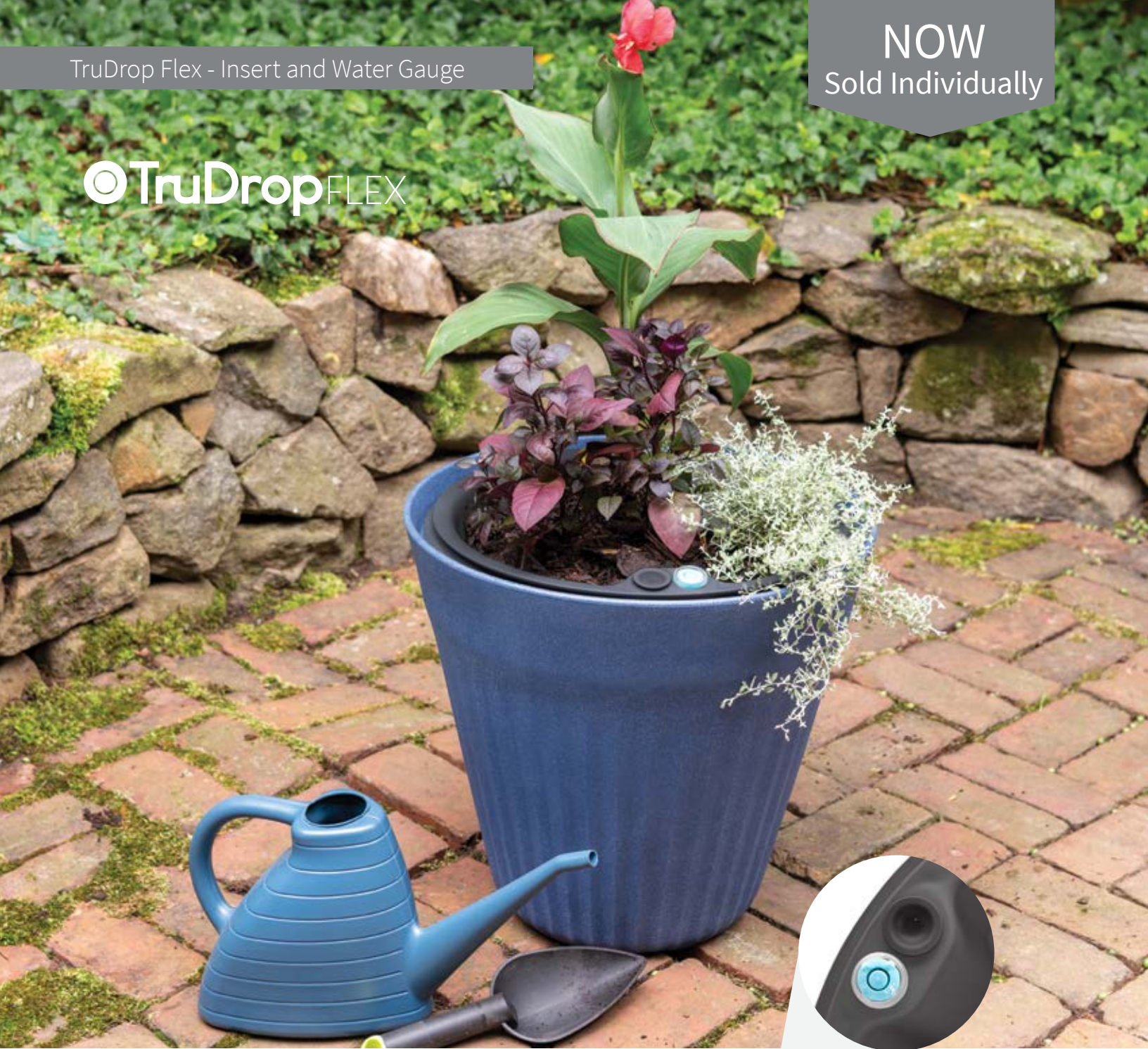

NOW
Sold Individually

© TruDrop FLEX



+



| | | dimensions | | | volume capacity | | insert ref.# | | | |
|---|----------------------------------------------------------------------------------|-----------------------------------------------------------------------------------|-----------------------------------------------------------------------------------|------------------------------------------------------------------------------------|-------------------------------------------------------------------------------------|-------------------------------------------------------------------------------------|-------------------------------------------------------------------------------------|-------------------|-------------------|-------------|
| | | soil | | water | | | | | | |
| |  |  |  |  |  |  |  | | | |
| A | Insert, Water Gauge and Cap 15" Planters (Small) | 13.54 34,4 | in cm | 8.66 22,0 | in cm | 12.91 32,8 | in cm | 2.59 gal 9,8 l | 1.74 gal 6,6 l | BT001I15193 |
| B | Insert, Water Gauge and Cap 18" Planters (Medium) | 16.69 42,4 | | 10.24 26,0 | | 15.59 39,6 | | 4.49 17,0 | 3.70 14,0 | BT001I18193 |
| C | Insert, Water Gauge and Cap 22" Planters (Large) | 20.63 52,4 | | 12.20 31,0 | | 18.94 48,1 | | 9.25 35,0 | 6.21 23,5 | BT001I22193 |



20 pcs of insert 18" are stacked, shipped inside another box

Easy to read water level indicator.

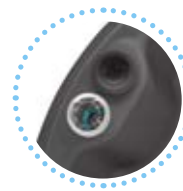

EMPTY



1/2



FULL





10 YEAR WARRANTY PLANTERS



Longevity

Crescent Garden rotationally molded products provide a great value to consumers given their 10 year limited warranty.

Protecting Surfaces

We offer a variety of universal saucers, caddies and other solutions to protect surfaces indoors or outdoors.

Well Designed

Every planter is detailed to deliver durability, better gardening solutions, and versatility in color and style.

100% Recyclable

All our products are manufactured with polymer type ♻️ and can be recycled.

What makes our Planters Unique

Double Wall

To protect roots from extreme temperatures, select our double wall planters that have a pocket of air between roots and the external wall.

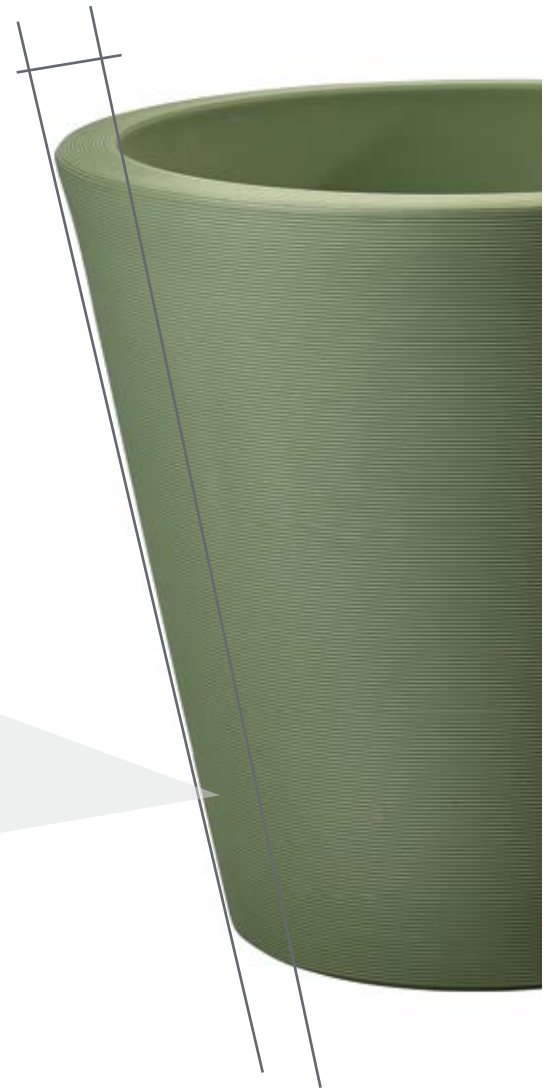

Lightweight

Our planters will make install a worry free process. We will make sure everything arrives to site intact and you won't need a large crew to get started.



10 Year Warranty

Our 10 Year Warranty against fading, or cracking will guarantee that you won't have complaints down the road.



Drainage

Healthy plants start with proper drainage. We design ours with elevated pot feet and drainage holes that are adequately sized for each planter.



Variety

Every style is available in stock in a curated selection of finishes, offering designers variety.

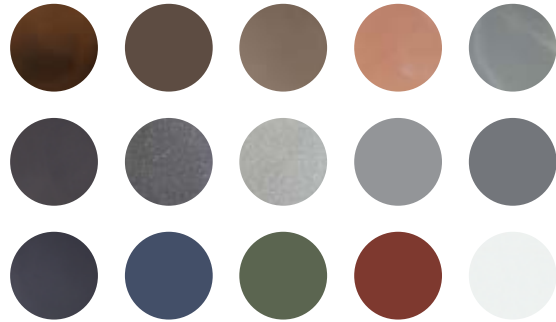

Bowls

Bowls have so many uses in a garden setting we wanted to make sure to provide you with a solution that works for all of those; our plugs allow you to easily change a bowl from a succulent garden, to a water garden or convert it into a bubbling fountain.



Use regular plug
for water gardens.



Use plug with hole
for fountains.



Use with no plug
for planting.



Gravity Cavity

Tall planters can be challenging in windy areas, so we designed ours with an internal cavity that can be filled with sand to weigh them down.

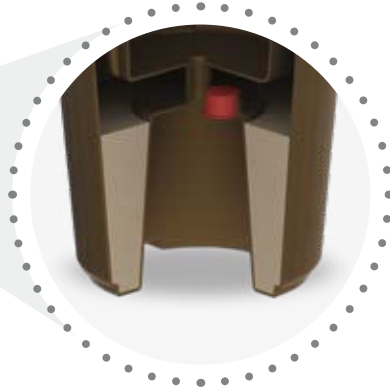

Attainable Design

Many of our planters are designed with a single wall for a value oriented option that still has a 10 Yr Warranty.





Designing with Plants:
Carefully curated containers create a mini-garden
to soften hardscapes.



Young and Hip:
This step planter targets newbies who are looking for design.



Cityscapes:
Lightweight planters are ideal for rooftops and balconies where weight can be a concern.



Commercial Applications:
The Bowery planters are ideal to create visual boundaries in open spaces.



Entryway Solutions:
Our Leyla urn is perfect for those looking for a classic style at their doorstep.



Simplicity:
Adding green in narrow spaces is easily achieved with an oval shaped planter.





Agave Planters



Texture Detail



Caviar Black

|  | | dimensions | | | | volume capacity | planter ref.# | saucer ref.# |
|-----------------------------------------------------------------------------------|-------------------|-----------------------------------------------------------------------------------|-----------------------------------------------------------------------------------|-----------------------------------------------------------------------------------|------------------------------------------------------------------------------------|--------------------|---------------|--------------|
| | |  |  |  |  | | | |
| A | Agave 14" Planter | 13.75 in 34,9 cm | 7.75 in 19,7 cm | 11.75 in 29,8 cm | 11.00 in 27,9 cm | 4.50 gal 17,0 l | A1935XX | A9910XXT |
| B | Agave 18" Planter | 17.75 45,1 | 10.25 26,0 | 15.00 38,1 | 13.50 34,3 | 9.00 34,1 | A1945XX | A9913XXT |
| C | Agave 21" Planter | 21.73 55,2 | 12.25 31,1 | 19.00 48,3 | 17.25 43,8 | 17.75 67,2 | A1950XX | A9915XXT |

10Year
Limited
Warranty

IN-STOCK QUICK SHIP COLORS



Caviar Black Ref: 94



Parchment Ref: 11



Rust Ref: 33

Bleeker Planters



Texture Detail









Old Bronze



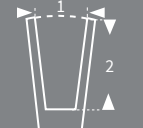

Caviar Black

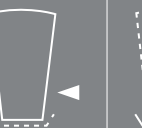

Mocha

|  | | dimensions | | | | volume capacity | planter ref.# | saucer ref.# |
|----------------------------------------------------------------------------------|---------------------|-----------------------------------------------------------------------------------|-----------------------------------------------------------------------------------|-----------------------------------------------------------------------------------|------------------------------------------------------------------------------------|-------------------------------------------------------------------------------------|-------------------------------------------------------------------------------------|-------------------------------------------------------------------------------------|
| | |  |  |  |  |  |  |  |
| A | Bleeker 13" Planter | 13.19 in 33,5 cm | 8.60 in 21,8 cm | 10.21 / 17.75 in 25,9 / 45,1 cm | 25.50 in 64,8 cm | 4.5 gal 17,0 l | A3933XX | A9910XXT |
| B | Bleeker 15" Planter | 15.28 38,8 | 9.53 24,2 | 11.80 / 21.75 30,0 / 55,2 | 31.20 79,2 | 7.2 27,3 | A3938XX | A9910XXT |
| C | Bleeker 17" Planter | 17.13 43,5 | 10.82 27,5 | 13.65 / 24.75 34,7 / 62,9 | 35.00 88,9 | 11.00 41,6 | A3943XX | A9910XXT |

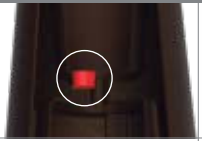
This planter can be filled with sand for additional stability:

| | | |
|-----------------------------------------------------------------------------------|-----------------------------------------------------------------------------------|-----------------------------------------------------------------------------------|
|  |  |  |
| Place planter upside down. | Remove red plug. | Use a funnel to fill cavity with sand. Replug and turn right side up. |



IN-STOCK QUICK SHIP COLORS



Old Bronze Ref: 14



Caviar Black Ref: 94



Slate Ref: 97

Bowery Planters



Silt and Lavender





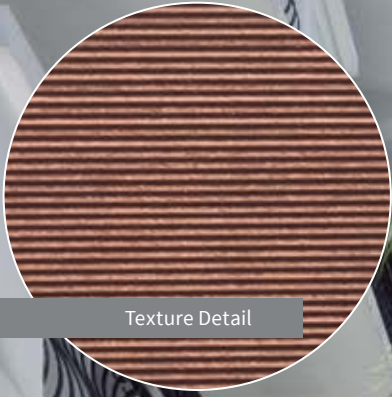



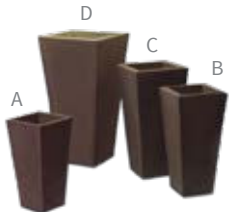

Bowery Planters





Texture Detail



|  | | dimensions | | | | volume capacity | planter ref.# | saucer ref.# |
|----------------------------------------------------------------------------------|--------------------|-----------------------------------------------------------------------------------|-----------------------------------------------------------------------------------|-----------------------------------------------------------------------------------|------------------------------------------------------------------------------------|-------------------------------------------------------------------------------------|-------------------------------------------------------------------------------------|-------------------------------------------------------------------------------------|
| | |  |  |  |  |  |  |  |
| A | Bowery 13" Planter | 13.00 in 33,0 cm | 8.55 in 21,7 cm | 10.50 / 17.69 in 26,7 / 44,9 cm | 25.50 in 64,8 cm | 6.00 gal 22,7 l | A5110XX | A9822XXT |
| B | Bowery 15" Planter | 14.80 37,6 | 9.71 24,7 | 11.00 / 18.00 27,9 / 45,7 | 30.77 78,2 | 7.50 28,4 | A5138XX | A9827XXT |
| C | Bowery 17" Planter | 17.00 43,2 | 10.78 27,4 | 13.00 / 20.00 33,0 / 50,8 | 34.70 88,1 | 12.00 45,4 | A5143XX | A9832XXT |
| D | Bowery 22" Planter | 22.00 55,9 | 14.08 35,8 | 17.90 / 26.60 45,5 / 67,6 | 43.20 109,7 | 29.00 109,8 | A5155XX | A9841XXT |

This planter can be filled with sand for additional stability:

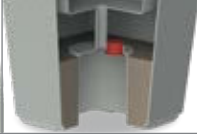
| | | |
|-----------------------------------------------------------------------------------|-----------------------------------------------------------------------------------|-----------------------------------------------------------------------------------|
|  |  |  |
| Place planter upside down. | Remove red plug. | Use a funnel to fill cavity with sand. Replug and turn right side up. |



IN-STOCK QUICK SHIP COLORS



Old Bronze Ref: 14



Caviar Black Ref: 94



Mocha Ref: 44



Slate Ref: 97





Brunello Rolled-Rim Planters



Texture Detail



Caviar Black

|  | | dimensions | | | | volume capacity | planter ref.# | saucer ref.# |
|----------------------------------------------------------------------------------|----------------------------------------------------------|-----------------------------------------------------------------------------------|-----------------------------------------------------------------------------------|-----------------------------------------------------------------------------------|------------------------------------------------------------------------------------|-----------------------|---------------|--------------|
| | |  |  |  |  | | | |
| A | Brunello Rolled-Rim 12" Planter | 11.40 in 29,0 cm | 6.50 in 16,5 cm | 9.68 in 24,6 cm | 9.25 in 23,5 cm | 2.25 gal 8,5 l | A2630XX | A9908XXT |
| B | Brunello Rolled-Rim 14" Planter | 13.50 in 34,3 cm | 8.00 in 20,3 cm | 11.40 in 29,0 cm | 10.75 in 27,3 cm | 3.50 gal 13,2 l | A2635XX | A9908XXT |
| C | Brunello Rolled-Rim 16" Planter | 16.00 in 40,6 cm | 9.50 in 24,1 cm | 13.50 in 34,3 cm | 12.50 in 31,8 cm | 5.75 gal 21,8 l | A2640XX | A9910XXT |
| D | Brunello Rolled-Rim 20" Planter | 20.00 in 50,8 cm | 12.00 in 30,5 cm | 17.70 in 45,0 cm | 15.75 in 40,0 cm | 11.75 gal 44,5 l | A2650XX | A9913XXT |
| E | Brunello Rolled-Rim 27" Planter | 27.36 in 69,5 cm | 16.00 in 40,6 cm | 23.70 in 60,2 cm | 21.50 in 54,6 cm | 41.50 gal 157,1 l | A2668XX | A9918XXT |
| F | Brunello Rolled-Rim 31" Planter | 31.50 in 80,0 cm | 17.75 in 45,1 cm | 27.40 in 69,6 cm | 25.00 in 63,5 cm | 44.50 gal 168,5 l | A2680XX | A9985XXT |
| G | Brunello Rolled-Rim 35" Planter | 35.00 in 88,9 cm | 20.25 in 51,4 cm | 31.20 in 79,2 cm | 28.75 in 73,0 cm | 69.00 gal 261,2 l | A2690XX | A9990XXT |
| H | Brunello Rolled-Rim Wide Bottom Commercial 37" Planter** | 37.00 in 94,0 cm | 24.25 in 61,6 cm | 34.20 in 86,9 cm | 28.75 in 73,0 cm | 84.00 gal 318,0 l | A2695XX | N/A |
| I | Brunello Rolled-Rim Wide Bottom Commercial 44" Planter** | 44.00 in 111,8 cm | 28.25 in 71,8 cm | 40.47 in 102,8 cm | 34.00 in 86,4 cm | 139.25 gal 527,1 l | A26110XX | N/A |

10Year
Limited
Warranty

IN-STOCK QUICK SHIP COLORS



Caviar Black Ref: 94**



Weathered Concrete Ref: 92



Parchment Ref: 11



Rust Ref: 33



Weathered Terracotta Ref: 34**

** Please note that the 37" and 44" planters are only available in stock in Weathered Terracotta and Caviar Black, but can be special ordered in any of our finishes.





Delano Planters





Texture Detail



Slate

|  | | dimensions | | | | volume capacity | planter ref.# | saucer ref.# |
|----------------------------------------------------------------------------------|---------------------|-----------------------------------------------------------------------------------|-----------------------------------------------------------------------------------|-----------------------------------------------------------------------------------|------------------------------------------------------------------------------------|-------------------|---------------|--------------|
| | |  |  |  |  | | | |
| A | Delano 16" Planter | 15.75 in 40,0 cm | 7.00 in 17,8 cm | 13.70 / 6.30 in 34,8 / 16,0 cm | 7.80 in 19,8 cm | 2.25 gal 8,5 l | A5340XX | A9908XXT |
| B | Delano 20" Planter | 20.00 50,8 | 8.10 20,6 | 17.70 / 7.48 45,0 / 19,0 | 10.00 25,4 | 4.50 17,0 | A5350XX | A9910XXT |
| C | Delano 26" Planter | 26.00 66,0 | 10.50 26,7 | 23.70 / 9.84 60,2 / 25,0 | 13.00 33,0 | 10.75 40,7 | A5366XX | A9913XXT |
| D | Delano 34" Planter* | 33.70 85,6 | 13.70 34,8 | 31.70 / 13.78 80,5 / 35,0 | 17.00 43,2 | 24.00 90,8 | A5386XX | A9915XXT |

***Plug System Included for 34" Bowl**

| | | |
|-----------------------------------------------------------------------------------|-----------------------------------------------------------------------------------|-----------------------------------------------------------------------------------|
|  |  |  |
| Use regular plug for water gardens. | Use plug with hole for fountains. | Use with no plug for planting. |



IN-STOCK QUICK SHIP COLORS



Old Bronze Ref: 14



Caviar Black Ref: 94



Mocha Ref: 44



Slate Ref: 97







Midnight Ref: 55



Delano Oval Bowls

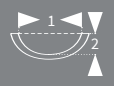

Texture Detail



|  | | dimensions | | | | volume capacity | planter ref.# |
|----------------------------------------------------------------------------------|----------------------|-----------------------------------------------------------------------------------|-----------------------------------------------------------------------------------|------------------------------------------------------------------------------------|-------------------------------------------------------------------------------------|--------------------|---------------|
| | |  |  |  |  | | |
| A | Delano Oval 24" Bowl | 24.00 x 17.00 in 61,0 x 43,2 cm | 14.10 x 10.00 in 35,8 x 25,4 cm | 21.50 x 14.50 / 5.91 in 54,6 x 36,8 / 15,0 cm | 8.00 in 20,3 cm | 3.75 gal 14,2 l | A5460XX |
| B | Delano Oval 30" Bowl | 30.00 x 21.10 76,2 x 53,6 | 16.30 x 11.60 41,4 x 29,5 | 27.40 x 18.70 / 7.28 69,6 x 47,5 / 18,5 | 10.00 25,4 | 7.75 29,3 | A5476XX |

| Plug System Included | | |
|-----------------------------------------------------------------------------------|-----------------------------------------------------------------------------------|-----------------------------------------------------------------------------------|
|  |  |  |
| Use regular plug for water gardens. | Use plug with hole for fountains. | Use with no plug for planting. |



IN-STOCK QUICK SHIP COLORS



Old Bronze Ref: 14



Caviar Black Ref: 94



Mocha Ref: 44



Slate Ref: 97







Midnight Ref: 55

Delano Tall Planters

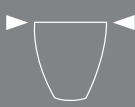

Texture Detail



|  | | dimensions | | | | volume capacity | planter ref.# | saucer ref.# |
|-----------------------------------------------------------------------------------------------|-------------------------|-----------------------------------------------------------------------------------|-----------------------------------------------------------------------------------|-----------------------------------------------------------------------------------|------------------------------------------------------------------------------------|--------------------|---------------|--------------|
| | |  |  |  |  | | | |
| A | Delano Tall 16" Planter | 16.00 in 40,6 cm | 7.10 in 18,0 cm | 13.10 / 12.20 in 33,3 / 31,0 cm | 17.60 in 44,7 cm | 4.50 gal 17,0 l | A5540XX | A9908XXT |



IN-STOCK QUICK SHIP COLORS



Old Bronze Ref: 14



Caviar Black Ref: 94



Mocha Ref: 44



Slate Ref: 97



Midnight Ref: 55

Eye Planters



Cloud White



Eye Planters

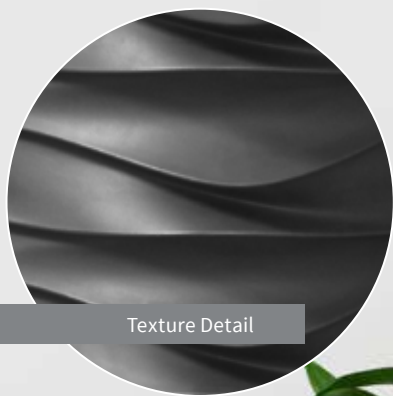

Texture Detail



Caviar Black

| | | dimensions | | | | volume capacity | planter ref.# |
|---|-----------------------|---------------------|---------------------|---------------------------------------------------|---------------------|---------------------|---------------|
| | | | | | | | |
| A | Eye Ain't 26" Planter | 26.30 in 66,8 cm | 21.85 in 55,5 cm | 13.60 / 17.09 in 34,5 / 43,4 cm | 18.70 in 47,5 cm | 9.25 gal 35,0 l | A7966XX |
| B | Eye Am 26" Planter | 26.00 in 66,0 cm | 21.00 in 53,3 cm | 21.90 x 14.50 / 22.76 in 55,6 x 36,8 / 57,8 cm | 24.60 in 62,5 cm | 13.00 gal 49,2 l | A7866XX |



IN-STOCK QUICK SHIP COLORS



Caviar Black Ref: 94



Cloud White Ref: 00



Slate Ref: 97

Fold Planters







NOW
Sold Individually



Texture Detail



Bedrock Circular+

|  | | dimensions | | | volume capacity | planter ref.# | | | | |
|-----------------------------------------------------------------------------------|---------------------------|-----------------------------------------------------------------------------------|-----------------------------------------------------------------------------------|------------------------------------------------------------------------------------|-------------------------------------------------------------------------------------|-------------------------------------------------------------------------------------|----------|---------------|----------|------------|
| | |  |  |  |  |  | | | | |
| A | Fold 15" Planter (Small) | 14.96 38,0 | in cm | 9.37 23,8 | in cm | 13.58 34,5 | in cm | 6.08 23,0 | gal l | B09015MXXX |
| B | Fold 18" Planter (Medium) | 18.11 46,0 | | 9.45 24,0 | | 16.69 42,4 | | 10.88 41,2 | | B09018MXXX |
| C | Fold 22" Planter (Large) | 22.05 56,0 | | 13.39 34,0 | | 19.88 50,5 | | 19.55 74,0 | | B09022MXXX |

Add TruDrop Flex insert for self-watering alternative. Page 83



TruDrop



IN-STOCK QUICK SHIP COLORS



Autumn Circular + Ref: U33



Bedrock Circular Ref: U93



Juniper Circular + Ref: U60



Coal Circular + Ref: U94







Leyla Urn



Texture Detail



Caviar Black

| | | | | | | | | |
|----------------------------------------------------------------------------------|-----------------------------------------------------------------------------------|-----------------------------------------------------------------------------------|------------------------------------------------------------------------------------|-------------------------------------------------------------------------------------|-------------------------------------------------------------------------------------|-------------------------------------------------------------------------------------|-----------------|---------------|
|  | dimensions | | | | | | volume capacity | planter ref.# |
| |  |  |  |  |  |  | | |
| A Leyla Urn | 22.20 in 56,4 cm | 13.75 x 14.00 in 34,9 x 35,6 cm | 18.85 / 12.40 in 47,9 / 31,5 cm | 28.25 in 71,8 cm | | 23.25 gal 88,0 l | A6955XX | |



IN-STOCK QUICK SHIP COLORS



Caviar Black Ref: 94



Mocha Ref: 44



...wants
...I want
...the rare yarbubir julung, a bollyn is dearest fit
...re mullory Molly are the big ideas mullion
...Turkey the favourite game off the always d
...he a beautifyn Torrenfino is very you interest
...memory called the memo super it million
...favourite. You don't na a famous people
...y called kind girl somebody went many
...you sorry for my Endun, some
...ful, colored don't coffe as m
...ful, colored don't coffe as m
...somebody
...somebody
...feeling it
...to go. A
...memorie
...Somebody
...nation celore







Madison Planters



Texture Detail

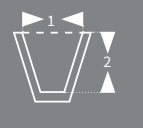

Slate

|  | | dimensions | | | | volume capacity | planter ref.# | saucer ref.# |
|----------------------------------------------------------------------------------|-----------------------|-----------------------------------------------------------------------------------|-----------------------------------------------------------------------------------|-----------------------------------------------------------------------------------|------------------------------------------------------------------------------------|--------------------|---------------|--------------|
| | |  |  |  |  | | | |
| A | Madison 14" Planter | 14.00 in 35,6 cm | 8.73 in 22,2 cm | 12.01 / 10.93 in 30,5 / 27,8 cm | 14.00 in 35,6 cm | 3.44 gal 13,0 l | A1135XXA | A9910XXT |
| B | Madison 16" Planter | 16.00 40,6 | 10.03 25,5 | 13.60 / 12.48 34,5 / 31,7 | 16.00 40,6 | 5.09 19,3 | A1140XXA | A9910XXT |
| C | Madison 20" Planter | 20.00 50,8 | 12.28 31,2 | 17.46 / 15.61 44,3 / 39,6 | 20.00 50,8 | 10.71 40,5 | A1150XXA | A9913XXT |
| D | Madison 26" Planter | 26.00 66,0 | 16.04 40,7 | 22.21 / 18.24 56,4 / 46,3 | 26.00 66,0 | 20.85 78,9 | A1165XXA | A9918XXT |
| E | Madison 34" Planter | 34.00 86,4 | 21.04 53,4 | 29.39 / 23.67 74,7 / 60,1 | 34.00 86,4 | 48.59 183,9 | A1180XXA | A9990XXT |
| F | Madison 48" Planter * | 48.20 122,5 | 29.10 74,0 | 33.00 / 41.70 84,0 / 106,0 | 47.40 120,5 | 170.00 650,0 | A11125XX | N/A |



IN-STOCK QUICK SHIP COLORS



Old Bronze Ref: 14



Caviar Black Ref: 94



Cloud White Ref: 00



Mocha Ref: 44



Weathered Terracotta Ref: 34



Slate Ref: 97



Midnight Ref: 55



Olive Ref: 82



Bark Ref: 74

*Please note that the 48" planter is only available in Caviar Black in stock but can be special ordered in all our other finishes.









Origami Planters



Texture Detail

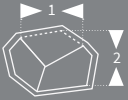

Cloud White

|  | | dimensions | | | | | | volume capacity | planter ref.# | | | |
|----------------------------------------------------------------------------------|--------------------------|-----------------------------------------------------------------------------------|----------|-----------------------------------------------------------------------------------|----------|------------------------------------------------------------------------------------|--|-----------------|---------------|-------------------------------------------------------------------------------------|--------------------|-------------------------------------------------------------------------------------|
| | |  | |  | |  | | | |  | |  |
| A | Origami 23" Planter | 23.00 58,4 | in cm | 23.00 58,4 | in cm | 13.50 x 12.50 / 10.05 34,3 x 31,8 / 25,5 | | in cm | 14.50 36,8 | in cm | 6.50 gal 24,6 l | A5658XX |
| B | Origami 26" Tall Planter | 25.75 65,4 | | 25.75 65,4 | | 17.00 x 16.00 / 17.80 43,2 x 40,6 / 45,2 | | | 25.00 63,5 | | 13.50 51,1 | A5766XX |



IN-STOCK QUICK SHIP COLORS



Caviar Black Ref: 94



Cloud White Ref: 00



Ash Ref: 98



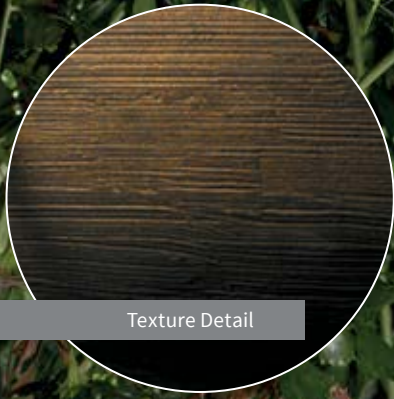



Orinoco Bowls



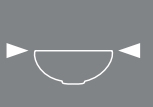

Texture Detail



Old Bronze

|  | | dimensions | | | | | | volume capacity | planter ref.# |
|-----------------------------------------------------------------------------------|----------------------------------------------------------------------------------------------------|-----------------------------------------------------------------------------------|-----------------------------------------------------------------------------------|------------------------------------------------------------------------------------|-------------------------------------------------------------------------------------|-------------------------------------------------------------------------------------|-------------------------------------------------------------------------------------|-----------------|---------------|
| | |  |  |  |  |  |  | | |
| A |  Orinoco 21" Bowl | 21.00 in 53,3 cm | 8.25 in 21,0 cm | 19.75 / 5.71 in 50,2 / 14,5 cm | 8.25 in 21,0 cm | 6.25 gal 23,7 l | A4655XX | | |
| B | Orinoco 30" Bowl* | 31.75 80,6 | 16.50 41,9 | 29.00 / 8.46 73,7 / 21,5 | 12.00 30,5 | 19.25 72,9 | A4680XX | | |
| C | Orinoco 40" Bowl* | 39.75 101,0 | 20.50 52,1 | 36.75 / 10.63 93,3 / 27,0 | 15.00 38,1 | 40.75 154,3 | A46100XX | | |

***Plug System Included for 30" and 40" Bowls**

| | | |
|-----------------------------------------------------------------------------------|-----------------------------------------------------------------------------------|-----------------------------------------------------------------------------------|
|  |  |  |
| Use regular plug for water gardens. | Use plug with hole for fountains. | Use with no plug for planting. |



IN-STOCK QUICK SHIP COLORS



Old Bronze Ref: 14



Caviar Black Ref: 94



Weathered Concrete Ref: 92

Pleat Planters







**ROOFTOP BAR
NOW OPEN**

39







Pleat Planters

Texture Detail

Olive



|  | | dimensions | | | | volume capacity | planter ref.# | saucer ref.# |
|---------------------------------------------------------------------------------|------------------------|-----------------------------------------------------------------------------------|-----------------------------------------------------------------------------------|-----------------------------------------------------------------------------------|------------------------------------------------------------------------------------|--------------------|---------------|--------------|
| | |  |  |  |  | | | |
| A | Pleat 15" Planter | 15.00 in 38,1 cm | 7.48 in 19,0 cm | 14.45 in 36,7 cm | 15.00 in 38,1 cm | 7.40 gal 28,0 l | A6638XX | A9908XXT |
| B | Pleat 19" Planter | 19.00 48,3 | 9.25 23,5 | 18.43 46,8 | 19.00 48,3 | 14.53 55,0 | A6648XX | A9910XXT |
| C | Pleat 23" Planter | 23.00 58,4 | 11.42 29,0 | 22.01 55,9 | 23.00 58,4 | 26.81 101,5 | A6658XX | A9913XXT |
| D | Pleat Tall 23" Planter | 23.00 58,4 | 11.42 29,0 | 22.01 55,9 | 27.00 68,6 | 32.10 121,5 | A6659XX | A9913XXT |
| E | Pleat 27" Planter | 27.00 68,6 | 14.17 36,0 | 26.42 67,1 | 27.00 68,6 | 46.23 175,0 | A6668XX | A9915XXT |
| F | Pleat Tall 27" Planter | 27.00 68,6 | 14.17 36,0 | 26.42 67,1 | 32.00 81,3 | 54.95 208,0 | A6669XX | A9915XXT |

10Year
Limited
Warranty

IN-STOCK QUICK SHIP COLORS



Caviar Black Ref: 94



Cloud White Ref: 00



Weathered Terracotta Ref: 34



Ash Ref: 98



Slate Ref: 97



Midnight Ref: 55



Olive Ref: 82



Bark Ref: 74

Ridge Planters





NOW
Sold Individually



Texture Detail



Autumn Circular+

|  | | dimensions | | | | | | volume capacity | planter ref.# | |
|-----------------------------------------------------------------------------------|----------------------------|-----------------------------------------------------------------------------------|----------|-----------------------------------------------------------------------------------|----------|------------------------------------------------------------------------------------|----------|-----------------|---------------|-------------------------------------------------------------------------------------|
| | |  | |  | |  | | | |  |
| A | Ridge 15" Planter (Small) | 14.96 38,0 | in cm | 8.86 22,5 | in cm | 13.58 34,5 | in cm | 5.55 21,0 | gal l | B08815MXXX |
| B | Ridge 18" Planter (Medium) | 18.11 46,0 | | 9.45 24,0 | | 16.69 42,4 | | 10.30 39,0 | | B08818MXXX |
| C | Ridge 22" Planter (Large) | 22.05 56,0 | | 12.52 31,8 | | 19.88 50,5 | | 18.49 70,0 | | B08822MXXX |

Add TruDrop Flex insert for self-watering alternative. Page 83



IN-STOCK QUICK SHIP COLORS



Autumn Circular + Ref: U33



Bedrock Circular Ref: U93



Juniper Circular + Ref: U60



Coal Circular + Ref: U94

Step Planters





NOW
Sold Individually



Texture Detail



Bedrock Circular+

|  | | dimensions | | | | | | volume capacity | planter ref.# | |
|-----------------------------------------------------------------------------------|---------------------------|-----------------------------------------------------------------------------------|----------|-----------------------------------------------------------------------------------|----------|------------------------------------------------------------------------------------|----------|-----------------|---------------|-------------------------------------------------------------------------------------|
| | |  | |  | |  | | | |  |
| A | Step 15" Planter (Small) | 14.96 38,0 | in cm | 8.86 22,5 | in cm | 13.58 34,5 | in cm | 6.08 23,0 | gal l | B08915MXXX |
| B | Step 18" Planter (Medium) | 18.11 46,0 | | 9.45 24,0 | | 16.69 42,4 | | 11.10 42,0 | | B08918MXXX |
| C | Step 22" Planter (Large) | 22.05 56,0 | | 12.87 32,7 | | 19.88 50,5 | | 19.81 75,0 | | B08922MXXX |

Add TruDrop Flex insert for self-watering alternative. Page 83



TruDrop



IN-STOCK QUICK SHIP COLORS



Autumn Circular + Ref: U33



Bedrock Circular Ref: U93



Juniper Circular + Ref: U60



Coal Circular + Ref: U94



Crescent**TOO**

EVERYDAY PLANTERS



Lightweight and Durable

Just like our traditional Crescent Garden planters these new products represent great quality in their category.

Modern Design

Our selection of sleek designs brings a new look to everyday garden products.

Great for Interiors and Exteriors

These planters are all available in stock with no holes making them ideal for use as cache-pots for smaller plants.



Great Merchandising Ideas

Bright colors and fun styles makes it easy to create attractive in store displays.

Smaller Sizes

Crescent Too planters start at 5" in diameter.

Dylan Rectangular Planters









Texture Detail



Charcoal



Terracotta

|  | | dimensions | | | planter ref.# | Saucer ref.# |
|---------------------------------------------------------------------------------|--------------------------------------------------------------------------------|-----------------------------------------------------------------------------------|-----------------------------------------------------------------------------------|------------------------------------------------------------------------------------|-------------------------------------------------------------------------------------|-------------------------------------------------------------------------------------|
| | |  |  |  |  |  |
| A | Dylan 31.5" x 14" x 13" Rectangular Planter (Bag of 3) | 31.50 in 80,0 cm | 13.78 in 35,0 cm | 12.99 in 33,0 cm | AZ2847XXC | AZ2847XXTC |
| | Dylan 31.5" Planter Assortment (6pk each Capuccino, Charcoal & Terracotta) | | | | AZ284788GA | |
| | Dylan 31.5" Saucer Pack Assortment (6pk each Capuccino, Charcoal & Terracotta) | | | | AZ284788GAT | |
| B | Dylan 39" x 18" x 16" Rectangular Planter (Bag of 3) | 39.37 in 100,0 cm | 17.72 in 45,0 cm | 15.75 in 40,0 cm | AZ2870XXC | AZ2870XXTC |
| C | Casters for Dylan Planters (Bag of 2)* | N/A | N/A | N/A | AZR03 | N/A |

* 39" Planter requires 6 casters; 31.5" requires 4 casters.



IN-STOCK QUICK SHIP COLORS



Terracotta Ref: 30



Cappuccino Ref: 44









Charcoal Ref: 93

Emma Bowls / Hanging Planters

Texture Detail



Cappuccino

|  | | dimensions | | | volume capacity | planter ref.# |
|-----------------------------------------------------------------------------------|-----------------------------------------|-----------------------------------------------------------------------------------|-----------------------------------------------------------------------------------|------------------------------------------------------------------------------------|-------------------------------------------------------------------------------------|-------------------------------------------------------------------------------------|
| | |  |  |  |  |  |
| A | Emma 12" Bowl (Bag of 12) | 12.00 in 30,5 cm | 6.00 in 15,2 cm | 4.70 in 11,9 cm | 1.30 gal 4,9 l | AZ1512XXC |
| B | Emma 14" Bowl (Bag of 12) | 14.00 in 35,6 cm | 7.75 in 19,7 cm | 5.00 in 12,7 cm | 1.90 gal 7,2 l | AZ1514XXC |
| C | Hook for use with Emma Bowl (Bag of 12) | N/A | N/A | 16.00 in 40,6 cm | N/A | AZ1500XXHC |



IN-STOCK QUICK SHIP COLORS



Terracotta Ref: 30



Cappuccino Ref: 44



Charcoal Ref: 93



Black Ref:94



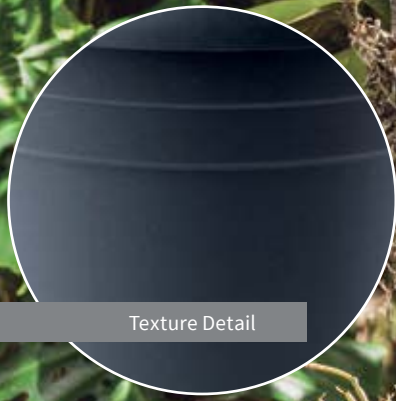



Emma Planters







Texture Detail



Charcoal

| |  | dimensions | | | | | | volume capacity | | planter ref.# |
|---|---------------------------------------------------------------------------------|-----------------------------------------------------------------------------------|---------|-----------------------------------------------------------------------------------|--------|------------------------------------------------------------------------------------|---------|-------------------------------------------------------------------------------------|-------|-------------------------------------------------------------------------------------|
| | |  | |  | |  | |  | |  |
| A | Emma 6" Planter (Bag of 12) | 6.3 in | 16,0 cm | 3.75 in | 9,5 cm | 4.72 in | 12,0 cm | 0.26 gal | 1,0 l | AZ1406XXC |
| B | Emma 8" Planter (Bag of 12) | 7.87 | 20,0 | 4.75 | 12,1 | 5.91 | 15,0 | 0.66 | 2,5 | AZ1408XXC |
| C | Emma 9" Planter (Bag of 12) | 9.00 | 22,9 | 5.00 | 12,7 | 7.50 | 19,1 | 1.10 | 4,2 | AZ1409XXC |
| D | Emma 10" Planter (Bag of 12) | 10.24 | 26,0 | 6.10 | 15,5 | 8.30 | 21,1 | 1.60 | 6,1 | AZ1410XXC |
| E | Emma 12" Planter (Bag of 12) | 12.00 | 30,5 | 6.75 | 17,1 | 10.00 | 25,4 | 2.40 | 9,1 | AZ1412XXC |
| F | Emma 14" Planter (Bag of 12) | 13.78 | 35,0 | 8.00 | 20,3 | 11.42 | 29,0 | 3.70 | 14,0 | AZ1414XXC |
| G | Emma 16" Planter (Bag of 6) | 15.70 | 39,9 | 9.00 | 22,9 | 13.00 | 33,0 | 5.30 | 20,1 | AZ1416XXC |
| H | Emma 18" Planter (Bag of 6) | 18.00 | 45,7 | 10.5 | 26,7 | 13.50 | 34,3 | 7.90 | 29,9 | AZ1418XXC |
| I | Emma 22" Planter (Bag of 6) | 21.50 | 54,6 | 13.25 | 33,7 | 16.50 | 41,9 | 13.20 | 50,0 | AZ1422XXC |
| J | Emma 25" Planter (Bag of 6) | 25.59 | 65,0 | 15.75 | 40,0 | 18.50 | 47,0 | 21.10 | 79,9 | AZ1425XXC |

| |  | dimensions | | | | saucer ref.# |
|---|-----------------------------------------------------------------------------------|-----------------------------------------------------------------------------------|---------|------------------------------------------------------------------------------------|--------|-------------------------------------------------------------------------------------|
| | |  | |  | |  |
| A | Emma 5.5" Saucer for 6" Planter (Bag of 12) | 5.51 in | 14,0 cm | 1.02 in | 2,6 cm | AZ9906XXTC |
| B | Emma 7" Saucer for 8" Planter (Bag of 12) | 7.09 | 18,0 | 1.06 | 2,7 | AZ9907XXTC |
| C | Emma 8" Saucer for 9" Planter (Bag of 12) | 7.90 | 18,0 | 1.10 | 2,8 | AZ9908XXTC |
| D | Emma 8.5" Saucer for 10" Planter (Bag of 12) | 8.66 | 22,0 | 1.18 | 3,0 | AZ9985XXTC |
| E | Emma 9.5" Saucer for 12" Planter (Bag of 12) | 9.40 | 23,9 | 1.30 | 3,3 | AZ9909XXTC |
| F | Emma 12" Saucer for 14" Planter (Bag of 6) | 11.80 | 30,0 | 1.60 | 4,1 | AZ9912XXTC |
| G | Emma 13" Saucer for 16" Planter (Bag of 6) | 13.00 | 33,0 | 1.80 | 4,6 | AZ9913XXTC |
| H | Emma 15" Saucer for 18" Planter (Bag of 6) | 15.00 | 38,1 | 2.00 | 5,1 | AZ9915XXTC |
| I | Emma 18" Saucer for 22" Planter (Bag of 6) | 18.10 | 46,0 | 2.20 | 5,6 | AZ9918XXTC |
| J | Emma 22" Saucer for 25" Planter (Bag of 6) | 21.60 | 54,9 | 2.50 | 6,4 | AZ9922XXTC |

IN-STOCK QUICK SHIP COLORS



Terracotta Ref: 30



Cappuccino Ref: 44



Charcoal Ref: 93



Black Ref: 94



Terracotta Ref: 30



Cappuccino Ref: 44



Charcoal Ref: 93



Black Ref: 94



Emma Round Planters and Saucers Display - Page 154



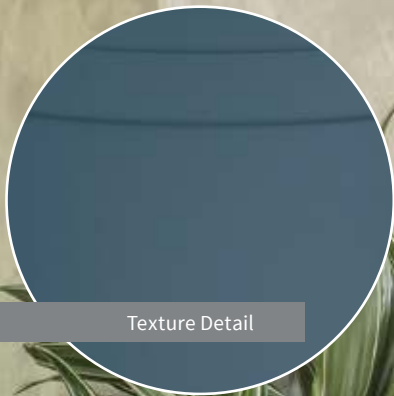



Emma Nature



Texture Detail



Ocean, Clay, Sun and Fog

|  A B C D | | dimensions | | | volume capacity | planter ref.# |
|----------------------------------------------------------------------------------------------|-------------------------------------|-----------------------------------------------------------------------------------|-----------------------------------------------------------------------------------|------------------------------------------------------------------------------------|-------------------------------------------------------------------------------------|-------------------------------------------------------------------------------------|
| | |  |  |  |  |  |
| A | Emma Nature 8" Planter (Bag of 12) | 7.87 in 20,0 cm | 4.75 in 12,1 cm | 5.91 in 15,0 cm | 0.66 gal 2,5 l | AZ1408XXC |
| B | Emma Nature 10" Planter (Bag of 12) | 10.24 in 26,0 cm | 6.10 in 15,5 cm | 8.30 in 21,1 cm | 1.60 gal 6,1 l | AZ1410XXC |
| C | Emma Nature 12" Planter (Bag of 12) | 12.00 in 30,5 cm | 6.75 in 17,1 cm | 10.00 in 25,4 cm | 2.40 gal 9,1 l | AZ1412XXC |
| D | Emma Nature 14" Planter (Bag of 12) | 13.78 in 35,0 cm | 8.00 in 20,3 cm | 11.42 in 29,0 cm | 3.70 gal 14,0 l | AZ1414XXC |

IN-STOCK QUICK SHIP COLORS



Clay Ref: 49



Ocean Ref: 53



Sun Ref: 16



Fog Ref: 74



Emma Nature Planters
Display - Page 155



made with **ubq**™



Introducing
Crescent**TOO**⁺

The **first** planter **of its kind**
made with **climate-positive** UBQ™ Material
for a **planet-positive** impact

The
Circular

Positive +
Planter

PRODUCTION AND LIFECYCLE

Upcycled from waste
Reduces landfill and emissions
Re-recyclable planters

IMPACT ON SUSTAINABILITY

Material **reduces** harmful emissions
Plant-positive containers & inserts
For a **Planet-Positive** environment

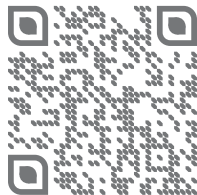





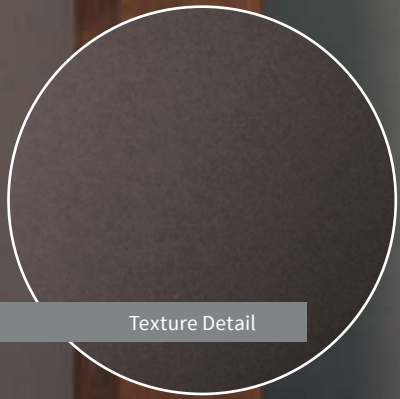

Learn More

Emma Circular Positive Planters



Texture Detail



|  | | dimensions | | | volume capacity | planter ref.# |
|----------------------------------------------------------------------------------|-------------------------------------|-----------------------------------------------------------------------------------|-----------------------------------------------------------------------------------|------------------------------------------------------------------------------------|-------------------------------------------------------------------------------------|-------------------------------------------------------------------------------------|
| | |  |  |  |  |  |
| A | Emma Nature 8" Planter (Bag of 12) | 7.87 in 20,0 cm | 4.75 in 12,1 cm | 5.91 in 15,0 cm | 0.66 gal 2,5 l | AZ1408XXC |
| B | Emma Nature 10" Planter (Bag of 12) | 10.24 in 26,0 cm | 6.10 in 15,5 cm | 8.30 in 21,1 cm | 1.60 gal 6,1 l | AZ1410XXC |
| C | Emma Nature 12" Planter (Bag of 12) | 12.00 in 30,5 cm | 6.75 in 17,1 cm | 10.00 in 25,4 cm | 2.40 gal 9,1 l | AZ1412XXC |
| D | Emma Nature 14" Planter (Bag of 12) | 13.78 in 35,0 cm | 8.00 in 20,3 cm | 11.42 in 29,0 cm | 3.70 gal 14,0 l | AZ1414XXC |



IN-STOCK QUICK SHIP COLORS



Terracotta Circular+ Ref: U30



Cappuccino Circular+ Ref: U44



Charcoal Circular+ Ref: U93



Juniper Circular+ Ref: U60



Emma Circular Positive Planters
Display - Page 155

Emma Rectangular Planters

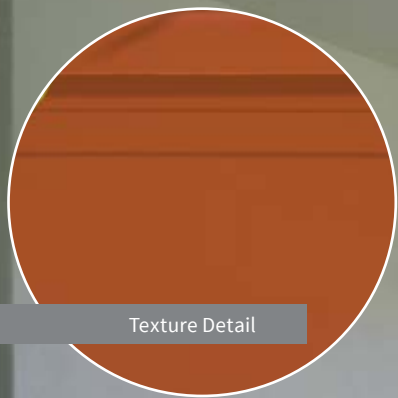





Texture Detail



Terracotta

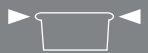
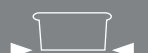

Terracotta

| |  | dimensions | | | volume capacity | planter ref.# |
|---|----------------------------------------------------------------------------------|-----------------------------------------------------------------------------------|-----------------------------------------------------------------------------------|------------------------------------------------------------------------------------|-------------------------------------------------------------------------------------|-------------------------------------------------------------------------------------|
| | |  |  |  |  |  |
| A | Emma 16.0" x 8.0" Rectangular Planter (Bag of 6) | 16.00 x 8.00 in 40,6 x 20,3 cm | 15.00 x 7.00 in 38,1 x 17,8 cm | 6.00 in 40,6 cm | 2.10 gal 7,9 l | AZ1616XXC |
| B | Emma 20.0" x 8.0" Rectangular Planter (Bag of 6) | 20.00 x 8.00 50,8 x 20,3 | 19.00 x 7.00 48,3 x 17,8 | 6.00 40,6 | 2.60 9,8 | AZ1620XXC |
| C | Emma 24.0" x 8.0" Rectangular Planter (Bag of 6) | 24.00 x 8.00 61,0 x 20,3 | 23.00 x 8.00 58,4 x 20,3 | 6.00 40,6 | 3.20 12,1 | AZ1624XXC |
| D | Metal Hanger for Emma Rectangular Planters (Bag of 6) | 16.00 Wide 40,6 | N/A | N/A | N/A | AZ168894HC |
| E | NEW Universal Brackets for Rectangular Planters (Page 204) | 15.75 Wide 18,0 | N/A | 7.09 18,0 | N/A | AZ850194C |



IN-STOCK QUICK SHIP COLORS



Terracotta Ref: 30



Cappuccino Ref: 44



Charcoal Ref: 93



Black Ref:94















Emma Rectangular Planters
Display- Page 155

A - Emma Round Planters and Saucers Display

Minimum Order for Free Display:

| product ref. # | description | qty |
|----------------|-----------------------------|---------------------------|
| AZ14DISP1 | Display for Emma Planters | 1 |
| AZ1409XXC | Emma 9" Planter | 1 bag of 12 in each color |
| AZ1412XXC | Emma 12" Planter | 1 bag of 12 in each color |
| AZ1414XXC | Emma 14" Planter | 1 bag of 12 in each color |
| AZ1416XXC | Emma 16" Planter | 2 bags of 6 in each color |
| AZ1418XXC | Emma 18" Planter | 2 bags of 6 in each color |
| AZ9908XXTC | Saucer for Emma 9" Planter | 1 bag of 12 in each color |
| AZ9909XXTC | Saucer for Emma 12" Planter | 1 bag of 12 in each color |
| AZ9912XXTC | Saucer for Emma 14" Planter | 1 bag of 12 in each color |
| AZ9913XXTC | Saucer for Emma 16" Planter | 2 bags of 6 in each color |
| AZ9915XXTC | Saucer for Emma 18" Planter | 2 bags of 6 in each color |

Use below to order color preference:

| assortment code | color selection | | |
|-----------------|------------------------------------------------------------------------------------------------|------------------------------------------------------------------------------------------------|------------------------------------------------------------------------------------------------|
| AZ148888AG |  Charcoal |  Cappuccino |  Terracotta |
| AZ148888BG |  Charcoal |  Cappuccino |  Black |
| AZ148888CG |  Charcoal |  Terracotta |  Black |
| AZ148888DG |  Cappuccino |  Terracotta |  Black |















PLEASE NOTE: Re-fill packs are available for dealers that already have a display in store.

B - Emma Rectangular Planters and Saucers Display

Minimum Order for Free Display:

| product ref. # | description | qty |
|----------------|---------------------------------|---------------------------|
| AZ16DISP1 | Display for Emma Rect. Planters | 1 |
| AZ1616XXC | Emma Rectangular 16 x 8 Planter | 3 bags of 6 in each color |
| AZ1620XXC | Emma Rectangular 20 x 8 Planter | 3 bags of 6 in each color |
| AZ1624XXC | Emma Rectangular 24 x 8 Planter | 3 bags of 6 in each color |

Use below to order color preference:

| assortment code | color selection | | |
|-----------------|-----------------------------------------------------------------------------------------------|-----------------------------------------------------------------------------------------------|----------------------------------------------------------------------------------------------|
| AZ168888AG |  Charcoal |  Cappuccino |  Terracotta |
| AZ168888BG |  Charcoal |  Cappuccino |  Black |
| AZ168888CG |  Charcoal |  Terracotta |  Black |
| AZ168888DG |  Cappuccino |  Terracotta |  Black |











C - Emma Planters Nature or Circular+ Display

Minimum Order for Free Display:

| product ref. # | description | qty |
|----------------|---------------------|---------------------------|
| AZ18DISP1 | Small Metal Display | 1 |
| AZ1408XXC | Emma 8" Planter | 1 bag of 12 in each color |
| AZ1410XXC | Emma 10" Planter | 1 bag of 12 in each color |
| AZ1412XXC | Emma 12" Planter | 1 bag of 12 in each color |
| AZ1414XXC | Emma 14" Planter | 1 bag of 12 in each color |

Use below to order color preference:

| assortment code | color selection | | | |
|-----------------|--------------------------------------------------------------------------------------------------------|----------------------------------------------------------------------------------------------------------|----------------------------------------------------------------------------------------------------------|-------------------------------------------------------------------------------------------------------|
| AZ148888FG |  Clay |  Ocean |  Sun |  Fog |
| AZ1488U88GG |  Charcoal Circular+ |  Cappuccino Circular+ |  Terracotta Circular+ |  Juniper Circular+ |



Eva Planters









Texture Detail

Gold



White and Fudge

|  | | dimensions | | | volume capacity | planter ref.# |
|---------------------------------------------------------------------------------|---------------------------------------|-----------------------------------------------------------------------------------|-----------------------------------------------------------------------------------|-------------------------------------------------------------------------------------|-------------------------------------------------------------------------------------|-------------------------------------------------------------------------------------|
| | |  |  |  |  |  |
| A | Eva 5.5" Planter (Case of 6) | 5.50 in 14,0 cm | 4.00 in 10,2 cm | 5.20 in 13,2 cm | 0.45 gal 1,7 l | AZ0105XXC |
| B | Eva 6.3" Planter (Case of 4) | 6.30 16,0 | 4.50 11,4 | 5.90 15,0 | 0.58 2,2 | AZ0106XXC |
| C | Eva 7.1" Planter (Case of 6) | 7.10 18,0 | 5.00 12,7 | 6.50 16,5 | 0.92 3,5 | AZ0107XXC |
| D | Eva 8.6" Planter (Case of 6) | 8.60 21,8 | 6.30 16,0 | 7.90 20,1 | 1.40 6,3 | AZ0109XXC |
| E | Eva 9.4" Planter (Case of 4) | 9.40 23,9 | 6.80 17,3 | 8.80 22,4 | 2.15 8,2 | AZ0110XXC |
| F | Eva 11.0" Planter (Case of 2) | 11.00 27,9 | 7.50 19,1 | 9.00 22,9 | 2.30 10,0 | AZ0111XXC |
| G | Eva 12.0" Planter (Case of 2) | 11.50 29,2 | 8.00 20,3 | 9.75 24,8 | 3.20 12,0 | AZ0112XXC |
| H | Eva 13.0" Planter (Case of 2) | 12.87 32,7 | 9.00 22,9 | 11.00 27,9 | 4.60 17,5 | AZ0114XXC |
| I | Eva 14.0" Planter (Case of 2) | 14.25 36,2 | 10.00 25,4 | 13.00 33,0 | 6.80 26,0 | AZ0116XXC |
| J | Eva 18.0" Planter (Sold Individually) | 17.75 45,1 | 12.00 30,5 | 15.00 38,1 | 11.00 44,0 | AZ0118XX |



IN-STOCK QUICK SHIP COLORS



White Ref: 00



Latte Ref: 70



Fudge Ref: 72



Black Ref: 94



Display Available - Page 169





Eva Planters Tabletop Cardboard Display

Minimum order for **free display**

| product ref.# | description | qty |
|---------------|------------------------------------|-----|
| | Tabletop Cardboard Display for Eva | 1 |
| AZ0105 | Eva 5.5" Planter | 27 |
| AZ0106 | Eva 6.3" Planter | 24 |
| AZ0107 | Eva 7.1" Planter | 18 |

Use below to order color preference:

| assortment code | color selection | | |
|-----------------|-----------------------------------------------------------------------------------------|-----------------------------------------------------------------------------------------|-----------------------------------------------------------------------------------------|
| AZ01888EG |  Latte |  Fudge |  White |
| AZ01888BG |  Latte |  Black |  White |



PLEASE NOTE: Displays are available only for use with Crescent Garden product.

Harvest Elevated Planters









Slate



Slate



Slate

|  | | dimensions | | | volume capacity | planter ref.# |
|----------------------------------------------------------------------------------|--------------------------------------------------------------------|-----------------------------------------------------------------------------------|-----------------------------------------------------------------------------------|------------------------------------------------------------------------------------|-------------------------------------------------------------------------------------|-------------------------------------------------------------------------------------|
| | |  |  |  |  |  |
| A | Harvest 30" x 16" Elevated Planter (Display of 18) | 29.92 in 76,0 cm | 15.16 in 38,5 cm | 26.77 in 68,0 cm | 15.06 gal 57,0 l | AZ824898G |
| B | Harvest 30" x 16" Elevated Planter and Greenhouse (Display of 13)* | 29.92 in 76,0 cm | 15.16 in 38,5 cm | 26.77 in 68,0 cm | 15.06 gal 57,0 l | AZ824898G1 |

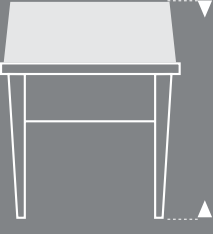
| *Height of Greenhouse | |
|-----------------------------------------------------------------------------------|-----------------------------------------------------------------------------------|
|  |  |
| 8.46 in 21,5 cm | 35.23 in 89.5 cm |



IN-STOCK QUICK SHIP COLORS

Display A:

1 Cardboard Display with 18 Harvest 30" x 16" Elevated Planters



Slate Ref: 98



Display B:

1 Cardboard Display with 13 Harvest 30" x 16" Elevated Planters and Greenhouse



Slate Ref: 98





MOBILITY AND DRAINAGE SOLUTIONS

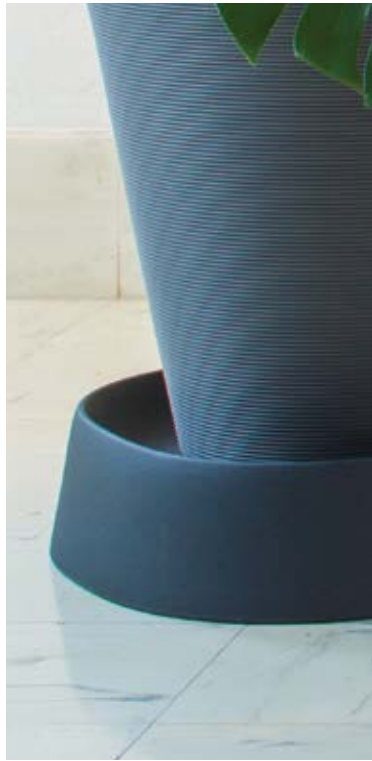

Successful Gardening

We know drainage is essential to healthy plants, but protecting surfaces is also important so we offer a variety of solutions to make it happen.

Innovative Solutions

Maintaining proper drainage is indispensable for the survival of containerized plants. Our accessories present a variety of innovative solutions.

Movable Planters

Once potted large planters can be heavy. Add mobility to some of our planters with our casters, to clean and transform spaces easily.

In-Store displays

These accessories are easy to merchandise with our ready to go display racks. We offer a variety of display options always considering smaller footprints and great visual appeal.

Pebble Plant Caddies







These planters can move:
Hidden casters make it easy to clean or move
your plants as the seasons change.



Pebble Plant Caddies



|  | | dimensions | | | | product ref.# |
|----------------------------------------------------------------------------------|---------------------------|-----------------------------------------------------------------------------------|----------|-------------------------------------------------------------------------------------|----------|-------------------------------------------------------------------------------------|
| | |  | |  | |  |
| A | Pebble Small Plant Caddy | 15.91 x 15.04 40,4 x 38,2 | in cm | 4.37 11,1 | in cm | A8040XXR |
| B | Pebble Medium Plant Caddy | 19.45 x 17.09 49,4 x 43,4 | | 3.98 10,1 | | A8050XXR |
| C | Pebble Large Plant Caddy | 23.39 x 19.69 59,4 x 50,0 | | 3.58 9,1 | | A8060XXR |

Caddies can easily support 200 pounds.



10Year*
Limited
Warranty

IN-STOCK QUICK SHIP COLORS



Caviar Black Ref: 94



Cloud White Ref: 00



Ash Ref: 98



Slate Ref: 97



Midnight Ref: 55



Olive Ref: 82



Bark Ref: 74



Currant Ref: 47

* 10 Year Limited Warranty for indoor use.

Pebble Large Plant Caddy Display



Cloud White

Pebble Large Plant Caddy Display

Minimum order for **free display**

| product ref.# | description | qty |
|---------------|----------------------------------|-----------|
| A80888RXK | Display for Pebble Plant Caddies | |
| A8040XXR | Pebble Small Plant Caddy | 8 Caddies |
| A8050XXR | Pebble Medium Plant Caddy | 6 Caddies |
| A8060XXR | Pebble Large Plant Caddy | 4 Caddies |

Use below to order color preference:





| assortment code | color selection | |
|-----------------|----------------------------------------------------------------------------------------------|------------------------------------------------------------------------------------------------|
| A80888REK |  Black |  White |
| A80888RFK |  Black |  Ash |
| A80888RGK |  Black |  Currant |
| A80888RHK |  White |  Midnight |
| A80888RIK |  Olive |  Bark |
| A80888RJK |  Slate |  Currant |

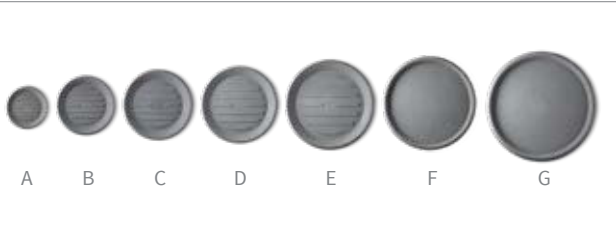

PLEASE NOTE: Displays are available only for use with Crescent Garden product.

Universal Round Saucers



|  | | dimensions | | | | | | product ref.# |
|---------------------------------------------------------------------------------|---------------------------------------------------------------------------------------------------------------------------------------------------------------------------|-----------------------------------------------------------------------------------|----------|------------------------------------------------------------------------------------|----------|-------------------------------------------------------------------------------------|----------|-------------------------------------------------------------------------------------|
| | |  | |  | |  | |  |
| A | 8" Circular Universal Saucer | 11.00 27,9 | in cm | 1.00 2,5 | in cm | 8.50 21,6 | in cm | A9908XXT |
| B | 11" Circular Universal Saucer | 15.00 38,1 | | 1.50 3,8 | | 11.00 27,9 | | A9910XXT |
| C | 13" Circular Universal Saucer | 18.00 45,7 | | 2.00 5,1 | | 13.25 33,7 | | A9913XXT |
| D | 15" Circular Universal Saucer | 20.00 50,8 | | 2.00 5,1 | | 15.50 39,4 | | A9915XXT |
| E | 18" Circular Universal Saucer | 23.50 59,7 | | 2.50 6,4 | | 18.50 47,0 | | A9918XXT |
| F | 19.7" Circular Universal Saucer | 22.00 55,9 | | 2.38 6,0 | | 19.75 50,2 | | A9985XXT |
| G | 22.8" Circular Universal Saucer | 25.50 64,8 | | 2.38 6,0 | | 23.00 58,4 | | A9990XXT |
| H | NEW Assorted Bundle Pack of Universal Saucers (Caviar Black or Weathered Terracotta) Includes: 20 ea of 8", 11" & 13", and 10 ea of 15" & 18" | | | | | | | A9988XXT |



10Year
Limited
Warranty

IN-STOCK QUICK SHIP COLORS

| | | | 8" Saucer | 11" Saucer | 13" Saucer | 15" Saucer | 18" Saucer | 19.7" Saucer | 22.8" Saucer |
|------------------------------------------------------------------------------------|---------|----------------------|--------------|---------------|---------------|---------------|---------------|-----------------|-----------------|
|  | Ref: 00 | Cloud White | ✓ | ✓ | ✓ | ✓ | ✓ | ✓ | ✓ |
|  | Ref: 92 | Weathered Concrete | ✓ | ✓ | ✓ | ✓ | ✓ | ✓ | ✓ |
|  | Ref: 98 | Ash | ✓ | ✓ | ✓ | ✓ | ✓ | ✓ | ✓ |
|  | Ref: 97 | Slate | ✓ | ✓ | ✓ | ✓ | ✓ | ✓ | ✓ |
|  | Ref: 14 | Old Bronze | ✓ | ✓ | ✓ | ✓ | ✓ | ✓ | ✓ |
|  | Ref: 94 | Caviar Black | ✓ | ✓ | ✓ | ✓ | ✓ | ✓ | ✓ |
|  | Ref: 33 | Rust | ✓ | ✓ | ✓ | ✓ | ✓ | ✓ | ✓ |
|  | Ref: 74 | Bark | ✓ | ✓ | ✓ | ✓ | ✓ | | ✓ |
|  | Ref: 44 | Mocha | ✓ | ✓ | ✓ | ✓ | ✓ | ✓ | ✓ |
|  | Ref: 34 | Weathered Terracotta | ✓ | ✓ | ✓ | ✓ | ✓ | ✓ | ✓ |
|  | Ref: 11 | Parchment | ✓ | ✓ | ✓ | ✓ | ✓ | ✓ | ✓ |
|  | Ref: 82 | Olive | ✓ | ✓ | ✓ | ✓ | ✓ | | ✓ |
|  | Ref: 55 | Midnight | ✓ | ✓ | ✓ | ✓ | ✓ | | ✓ |
|  | Ref: 55 | Shadow | | | | | | | |

Universal Square Saucers



| | A | B | C | D | dimensions | | | product ref.# | | | |
|---|------------------------------------------------------------------------------------------------------------------------------------------------------------------|---|---|---|-----------------------------------------------------------------------------------|------------------------------------------------------------------------------------|-------------------------------------------------------------------------------------|---------------|------------------------------|----------|----------|
| | | | | |  |  |  | | | | |
| A | 9" Square Universal Saucer | | | | 12.50 x 12.50 31,8 x 31,8 | in cm | 1.00 2,5 | in cm | 9.00 x 9.00 22,9 x 22,9 | in cm | A9822XXT |
| B | 11" Square Universal Saucer | | | | 14.50 x 14.50 36,8 x 36,8 | | 1.25 3,2 | | 11.20 x 11.20 28,4 x 28,4 | | A9827XXT |
| C | 13" Square Universal Saucer | | | | 16.75 x 16.75 42,5 x 42,5 | | 1.25 3,2 | | 13.25 x 13.25 33,7 x 33,7 | | A9832XXT |
| D | 16" Square Universal Saucer | | | | 19.75 x 19.75 50,2 x 50,2 | | 1.50 3,8 | | 16.25 x 16.25 41,3 x 41,3 | | A9841XXT |
| E | NEW Assorted Bundle Pack of Square Saucers (Caviar Black or Weathered Terracotta) Includes: 20 ea of 9" & 11" and 10 ea of 13" & 16" | | | | | | | | | | A9888XXT |

10Year
Limited
Warranty

IN-STOCK QUICK SHIP COLORS

| | | | 9" Saucer | 11" Saucer | 13" Saucer | 16" Saucer |
|------------------------------------------------------------------------------------|---------|----------------------|--------------|---------------|---------------|---------------|
|  | Ref: 00 | Cloud White | ✓ | ✓ | ✓ | ✓ |
|  | Ref: 92 | Weathered Concrete | ✓ | ✓ | ✓ | ✓ |
|  | Ref: 98 | Ash | ✓ | ✓ | ✓ | ✓ |
|  | Ref: 97 | Slate | ✓ | ✓ | ✓ | ✓ |
|  | Ref: 14 | Old Bronze | ✓ | ✓ | ✓ | ✓ |
|  | Ref: 94 | Caviar Black | ✓ | ✓ | ✓ | ✓ |
|  | Ref: 33 | Rust | ✓ | ✓ | ✓ | ✓ |
|  | Ref: 74 | Bark | | | | |
|  | Ref: 44 | Mocha | ✓ | ✓ | ✓ | ✓ |
|  | Ref: 34 | Weathered Terracotta | ✓ | ✓ | ✓ | ✓ |
|  | Ref: 11 | Parchment | ✓ | ✓ | ✓ | ✓ |
|  | Ref: 82 | Olive | | | | |
|  | Ref: 55 | Midnight | | | | |
|  | Ref: 55 | Shadow | | | | |

Universal Round Saucer Display

Minimum order for **free display**

| product ref.# | Saucer description: any color combination can be selected | qty |
|---------------|---------------------------------------------------------------|-----|
| A9908XXT | 8" (21,6 cm) ircular Universal Saucer | 20 |
| A9910XXT | 11" (27,9 cm) Circular Universal Saucer | 20 |
| A9913XXT | 13" (33,7 cm) Circular Universal Saucer | 20 |
| A9915XXT | 15" (39,4 cm) Circular Universal Saucer | 10 |
| A9918XXT | 18" (47,0 cm) Circular Universal Saucer | 10 |
| A99DISP1 | Display Unit for Circular Saucer includes baskets and signage | 1 |

Our in store displays are designed to show at **eye level** unlike traditional saucer displays that are short.



PLEASE NOTE: Displays are available only for use with Crescent Garden or Dotchi branded product.

Universal Square Saucer Display

Minimum order for **free display**

| product ref.# | Saucer description: any color combination can be selected | qty |
|---------------|-------------------------------------------------------------|-----|
| A9822XXT | 9" (22,9 cm) Square Universal Saucer | 20 |
| A9827XXT | 11" (28,4 cm) Square Universal Saucer | 20 |
| A9832XXT | 13" (33,7 cm) Square Universal Saucer | 10 |
| A9841XXT | 16" (41,3 cm) Square Universal Saucer | 10 |
| A98DISP1 | Display Unit for Square Saucer includes baskets and signage | 1 |

Our in store displays are designed to show at **eye level** unlike traditional saucer displays that are short.

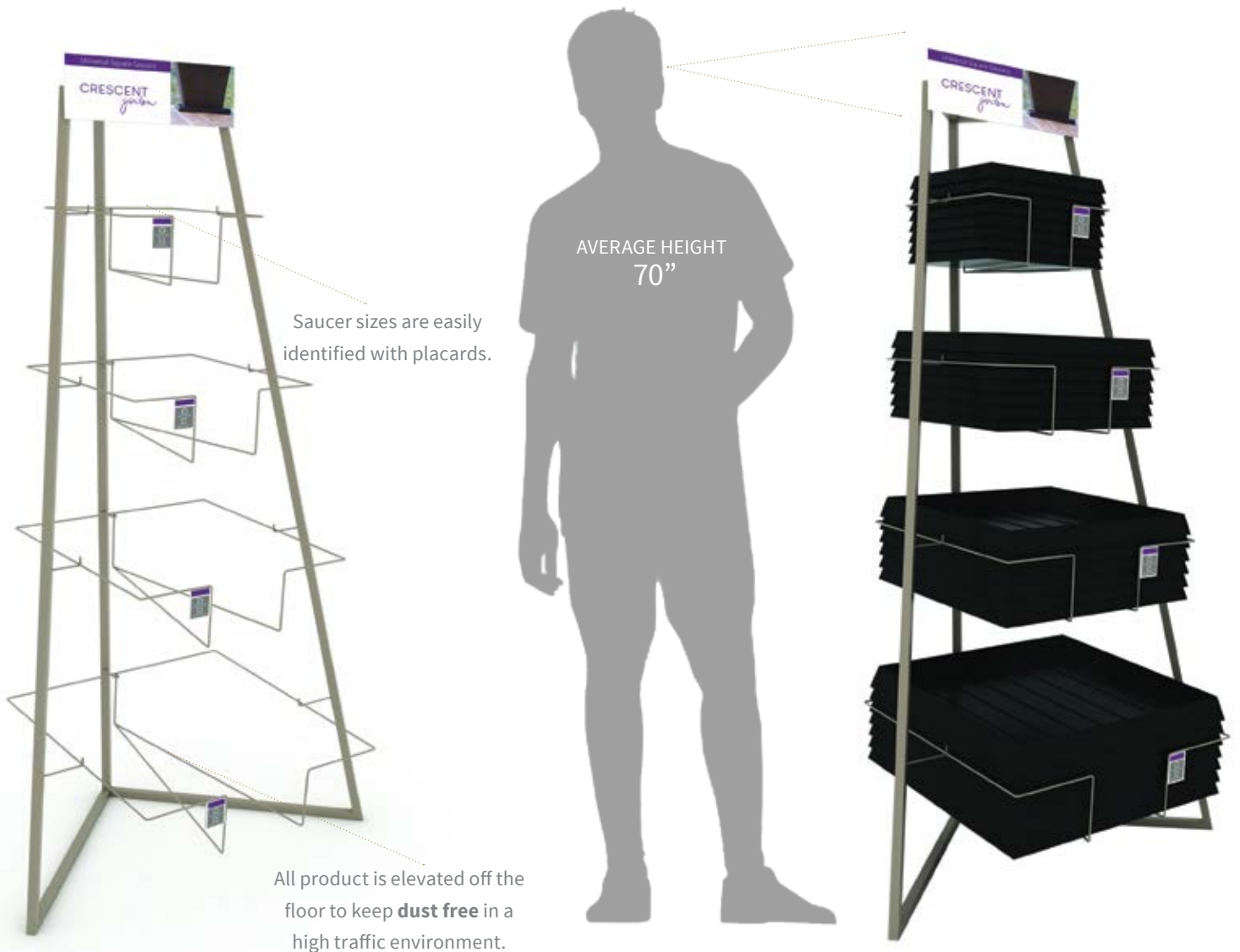

PLEASE NOTE: Displays are available only for use with Crescent Garden or Dotchi branded product.

Clear Saucer







Clear Deep Saucer









Heavy Duty Clear Saucer



Hanging Saucer

|  | | dimensions | | | | product ref.# |
|----------------------------------------------------------------------------------|------------------------------------------|-----------------------------------------------------------------------------------|---------|-------------------------------------------------------------------------------------|--------|-------------------------------------------------------------------------------------|
| | |  | |  | |  |
| A | Basic 4" Clear Saucer (Case of 50) | 4.00 in | 10,2 cm | 1.50 in | 3,8 cm | BV040S00C |
| B | Basic 6" Clear Saucer (Case of 50) | 6.10 | 15,5 | 1.50 | 3,8 | BV060S00C |
| | Heavy Duty 6" Clear Saucer (Case of 25) | 6.10 | 15,5 | 1.50 | 3,8 | BVH060S00C |
| C | Basic 8" Clear Saucer (Case of 50) | 8.10 | 20,6 | 1.50 | 3,8 | BV080S00C |
| | Heavy Duty 8" Clear Saucer (Case of 25) | 8.10 | 20,6 | 1.50 | 3,8 | BVH080S00C |
| D | Basic 10" Clear Saucer (Case of 50) | 10.10 | 25,7 | 1.50 | 3,8 | BV100S00C |
| | Heavy Duty 10" Clear Saucer (Case of 25) | 10.10 | 25,7 | 1.50 | 3,8 | BVH100S00C |
| E | Basic 12" Clear Saucer (Case of 50) | 12.10 | 30,7 | 1.50 | 3,8 | BV120S00C |
| | Heavy Duty 12" Clear Saucer (Case of 25) | 12.10 | 30,7 | 1.50 | 3,8 | BVH120S00C |
| F | Basic 14" Clear Saucer (Case of 25) | 14.10 | 35,8 | 2.10 | 5,3 | BV140S00C |
| | Heavy Duty 14" Clear Saucer (Case of 25) | 14.10 | 35,8 | 2.10 | 5,3 | BVH140S00C |
| G | Basic 17" Clear Saucer (Case of 25) | 17.10 | 43,4 | 2.10 | 5,3 | BV170S00C |

|  | | dimensions | | | | product ref.# |
|------------------------------------------------------------------------------------|------------------------------------------|------------------------------------------------------------------------------------|---------|--------------------------------------------------------------------------------------|--------|--------------------------------------------------------------------------------------|
| | |  | |  | |  |
| A | Basic 6" Clear Deep Saucer (Case of 50) | 6.10 in | 15,5 cm | 2.90 in | 7,4 cm | BV060D00C |
| B | Basic 8" Clear Deep Saucer (Case of 50) | 8.10 | 20,6 | 3.70 | 9,4 | BV080D00C |
| C | Basic 10" Clear Deep Saucer (Case of 50) | 10.10 | 25,7 | 3.70 | 9,4 | BV100D00C |
| D | Basic 12" Clear Deep Saucer (Case of 50) | 12.10 | 30,7 | 3.70 | 9,4 | BV120D00C |
| D | Basic 14" Clear Deep Saucer (Case of 25) | 14.10 | 35,8 | 4.72 | 12,0 | BV140D00C |

|  | | dimensions | | | | product ref.# |
|-------------------------------------------------------------------------------------|---------------------------------------------|-------------------------------------------------------------------------------------|---------|---------------------------------------------------------------------------------------|---------|---------------------------------------------------------------------------------------|
| | |  | |  | |  |
| A | Basic 10" Clear Hanging Saucer (Case of 25) | 10.00 in | 25,4 cm | 4.84 in | 12,3 cm | BV100H00C |



Hook Detail

Clear Saucer Display

Minimum order for free display

Standard Clear Saucers

| product ref. # | description | qty |
|----------------|-------------------------------|-----|
| BV060S00C | 6" Clear Saucer (Case of 50) | 4 |
| BV080S00C | 8" Clear Saucer (Case of 50) | 4 |
| BV100S00C | 10" Clear Saucer (Case of 50) | 3 |
| BV120S00C | 12" Clear Saucer (Case of 50) | 3 |
| BV140S00C | 14" Clear Saucer (Case of 25) | 4 |
| BVDISP1 | Clear Saucer Display | 1 |
| BV880S00G | Assortment | 1 |

Heavy Duty Saucers

| product ref. # | description | qty |
|----------------|------------------------------------------|-----|
| BVH060S00C | Heavy Duty 6" Clear Saucer (Case of 25) | 2 |
| BVH080S00C | Heavy Duty 8" Clear Saucer (Case of 25) | 2 |
| BVH100S00C | Heavy Duty 10" Clear Saucer (Case of 25) | 2 |
| BVH120S00C | Heavy Duty 12" Clear Saucer (Case of 25) | 2 |
| BVH140S00C | Heavy Duty 14" Clear Saucer (Case of 25) | 1 |
| BVDISP1 | Heavy Duty Clear Saucer Display | 1 |
| BVH880S00G | Assortment | 1 |

Our in store displays are designed to show at eye level unlike traditional saucer displays that are short.

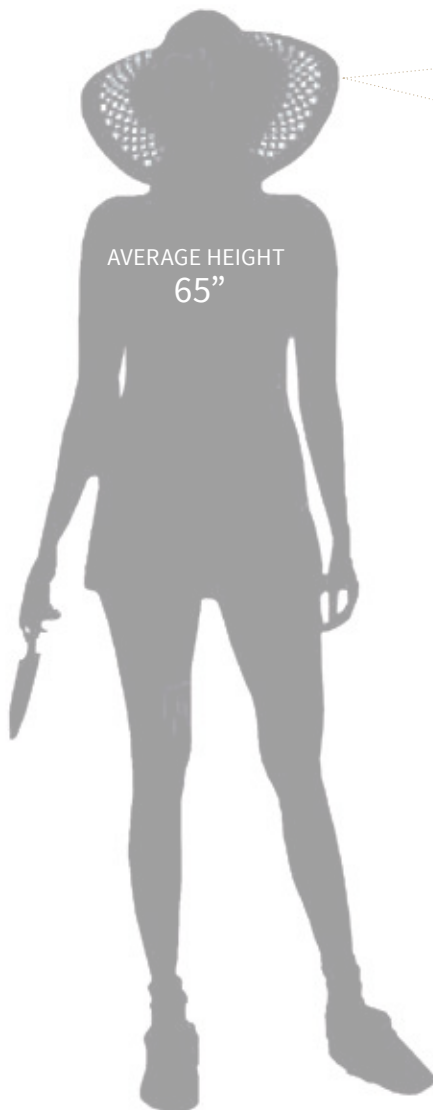

Saucer sizes are easily identified with placards.

All product is elevated off the floor to keep dust free in a high traffic environment.

PLEASE NOTE: Displays are available only for use with Crescent Garden or Dotchi branded product.

Clear Saucer Display

Minimum orders for free display

Clear Deep Saucers

| product ref. # | description | qty |
|----------------|------------------------------------|-----|
| BV080D00C | 8" Clear Deep Saucer (Case of 50) | 3 |
| BV100D00C | 10" Clear Deep Saucer (Case of 50) | 3 |
| BV120D00C | 12" Clear Deep Saucer (Case of 50) | 2 |
| BV140D00C | 14" Clear Deep Saucer (Case of 25) | 4 |
| BVDISP1 | Clear Saucer Display | 1 |
| BV880D00G | Assortment | 1 |

Our in store displays are designed to show at eye level unlike traditional saucer displays that are short.

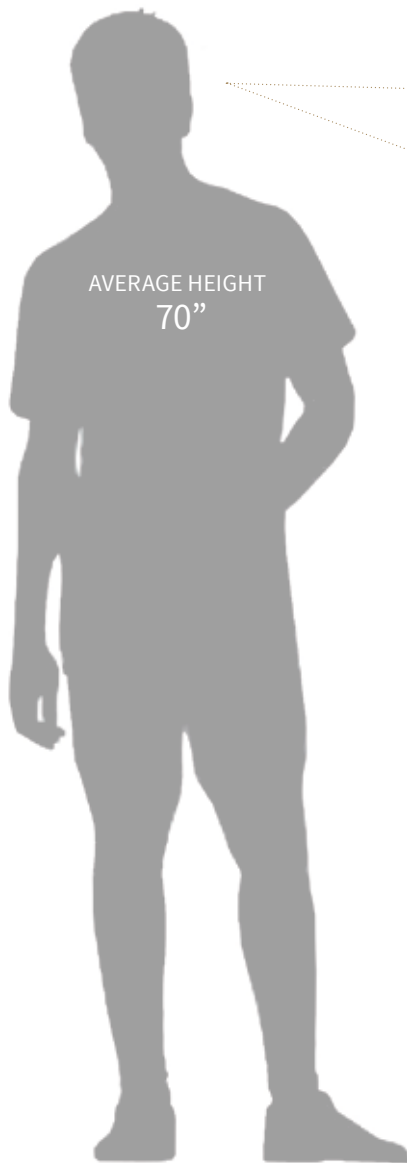



Saucer sizes are easily identified with placards.

All product is elevated off the floor to keep dust free in a high traffic environment.

PLEASE NOTE: Displays are available only for use with Crescent Garden or Dotchi branded product.

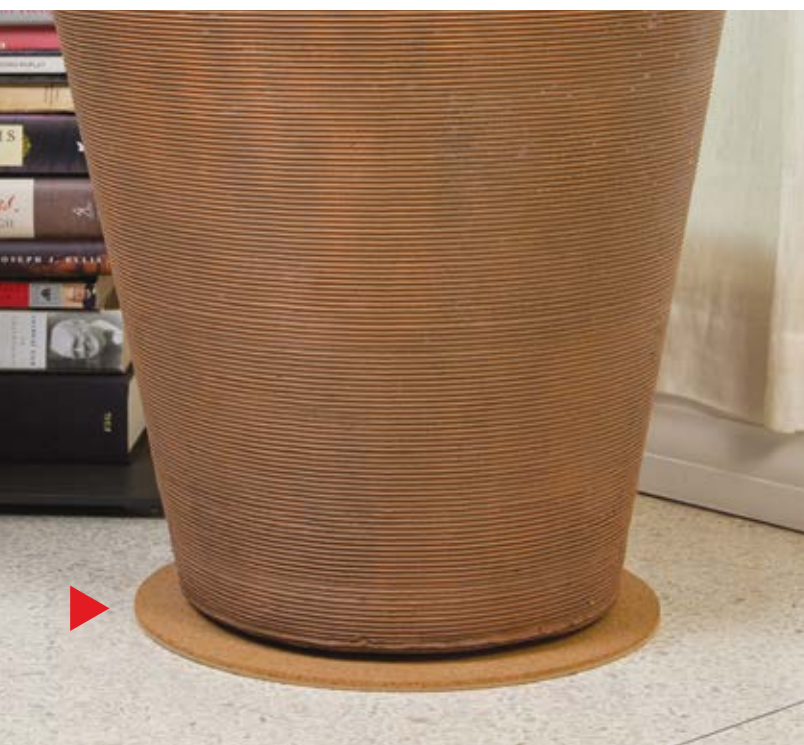
Cork Mats

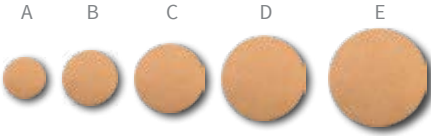

|  | | dimensions | | product ref.# |
|-----------------------------------------------------------------------------------|---------------------------|-----------------------------------------------------------------------------------|------|-------------------------------------------------------------------------------------|
| | |  | |  |
| A | 6" Cork Mat (Case of 25) | 6.00 | 15,2 | BC060S00C |
| B | 8" Cork Mat (Case of 25) | 8.00 | 20,3 | BC080S00C |
| C | 10" Cork Mat (Case of 25) | 10.00 | 25,4 | BC100S00C |
| D | 12" Cork Mat (Case of 25) | 12.00 | 30,5 | BC120S00C |
| E | 14" Cork Mat (Case of 25) | 14.00 | 35,6 | BC140S00C |

Minimum order for free display - Display for Cork Mats

| product ref. # | description | qty |
|----------------|---------------------------|-----|
| BC060S00C | 6" Cork Mat (Case of 25) | 1 |
| BC080S00C | 8" Cork Mat (Case of 25) | 1 |
| BC100S00C | 10" Cork Mat (Case of 25) | 1 |
| BC120S00C | 12" Cork Mat (Case of 25) | 1 |
| BC140S00C | 14" Cork Mat (Case of 25) | 1 |
| BCDISP1 | Cork Mat Display | 1 |
| BC880S00G | Assortment | 1 |

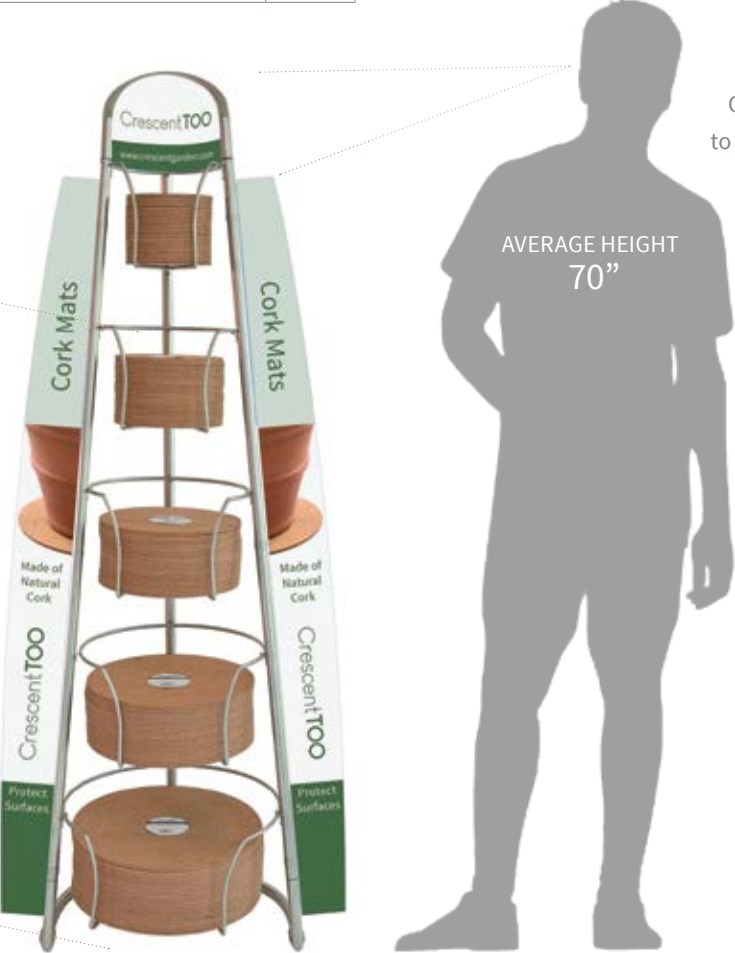

Cork mat sizes are easily identified with placards.

Our in store displays are designed to show at eye level unlike traditional saucer displays that are short.

AVERAGE HEIGHT 70"

All product is elevated off the floor to keep dust free in a high traffic environment.

PLEASE NOTE: Displays are available only for use with Crescent Garden or Dotchi branded product.



Crescent**TOO**

WATERING CANS
AND SPRAYERS



Functional Products

Each of these products is designed with function in mind: adjustable spraying nozzles, pressure sprayers that create fine mists, and now we even offer our new PRO line that can be turned 360 degrees and still spray.

Innovative Design

These are products that you don't need to hide when guests come over. Colorful and unique shapes like our Pinocchio can be a fashion statement for every gardener.

Colors that Sell

We study colors, and introduce new palettes to make sure that they merchandise effectively in the store. Colors are carried over between styles so you can easily mix and match and create your own story.

Watering Cans and Sprayers: Adding Color and Style





Cleo Watering Can





Energy PRO Pressure Sprayer 360°



Energy X Large Watering Can



| | | dimensions | | | product ref.# |
|---|------------------------------------------------------------------------------------------------------------------------------------------------------------------------------------------------|--------------------|--------------------|--------------------|---------------|
| | | Width | Height | volume capacity | |
| |   A B | | | | |
| A | Cleo Watering Can Assorted Colors (Case of 10: 4 lime, 3 snow and flint) | 4.75 in 12,1 cm | 5.50 in 14,0 cm | 0.333 gal 1,3 l | AZ181288C |
| B | Cleo Sprayer (Case of 9)* | 4.14 in 10,5 cm | 9.75 in 24,8 cm | 0.343 gal 1,3 l | BZ6313XXC |
| C | Cleo Watering Can and Sprayer Assortment in Assorted Colors (20 Watering Can and 18 Sprayers) | NA | NA | NA | BZ800088GK |

2Year
Limited
Warranty

IN-STOCK QUICK SHIP COLORS



Lime



Snow



Flint



Lime Ref: 61



Snow Ref: 12



Tools and Cleo Display - Page 207

* Sprayers are only available in Snow and Lime.

Energy Sprayers and Watering Cans



Energy X Large Watering Can



Energy Sprayer



Energy Pressure Sprayer

| | | | dimensions | | | | product ref.# | |
|---|-----------------------------------------------------------------------------------|----------------------------------------------------------------------------------|----------------------------------------------------------------------------------|------|--------|-------|---------------|-----------------|
| | | | Width | | Height | | | volume capacity |
| A |  |  |  | | | | | |
| A | Energy Sprayer (Case of 20) | | 4.75 | 12,1 | 10.75 | 27,3 | 0.27 1,0 | AZ221162C |
| | Energy Sprayer - Green (Case of 20) Custom Logo | | 4.75 | 12,1 | 10.75 | 27,3 | 0.27 1,0 | AZ221162C-I |
| B | Energy Pressure Sprayer (Case of 10) | | 5.75 | 14,6 | 11.00 | 27,9 | 0.30 1,1 | AZ241762C |
| C | Display Box (100 Energy Sprayers) | | 23.62 | 60,0 | 39.37 | 100,0 | NA | AZ221162G |

IN-STOCK QUICK SHIP COLORS



Green Ref: 62



Lime Ref: 62



Custom Printed



Display Box
(100 Energy Sprayers)

2Year
Limited
Warranty

| | | dimensions | | | | product ref.# | | |
|---|-------------------------------------------------------------------------------------|------------|---------|---------|----------|---------------|-----------------|------------|
| | | Width | | Height | | | volume capacity | |
| A |  | | | | | | | |
| A | Energy X Large Watering Can (Case of 12) | | 5.00 in | 12,7 cm | 11.50 in | 29,2 cm | 1.60 gal 6,1 l | AZ2360XXC |
| B | Gaylord (48 Energy X Large Watering Cans - Assorted Colors) | | 38.82 | 98,6 | 41.50 | 105,4 | N/A | AZ236088G1 |
| | Gaylord (96 Energy X Large Watering Cans - Assorted Colors) | | 48.00 | 121,9 | 40.00 | 101,6 | N/A | AZ236088G |

IN-STOCK QUICK SHIP COLORS



Green Ref: 62



Mandarin Ref: 37



B - Assorted Color Display
(48 Energy X Large Watering Cans)



B - Assorted Color Gaylord
(96 Energy X Large Watering Cans)

Energy PRO Sprayers 360°



Energy PRO Sprayer 360°

|  | | dimensions | | | product ref.# |
|----------------------------------------------------------------------------------|------------------------------------------------------|--------------------|---------------------|-------------------|---------------|
| | | Width | Height | volume capacity | |
| A | Energy PRO Sprayer 360° (Case of 20) - Green | 4.50 in 11,4 cm | 11.00 in 27,9 cm | 0.27 gal 1,0 l | AZ611162C |
| B | Energy PRO Pressure Sprayer 360° (Case of 8) - Green | 5.50 in 14,0 cm | 13.00 in 33,0 cm | 0.58 gal 2,2 l | AZ621701C |

Our Pro sprayers are 360 degrees and can be used even upside down. They come with adjustable brass nozzles that will last for a long time.



2Year
Limited
Warranty

IN-STOCK QUICK SHIP COLORS



Green Ref: 62

Eos Watering Can



Denim



NEW
SIZE

Khaki

| | | dimensions | | | product ref.# |
|----------------------------------------------------------------------------------|-----------------------------------------------------------------|--------------------|--------------------|-------------------|---------------|
| | | Width | Height | volume capacity | |
|  | | | | | |
| A | Eos 1 gallon Watering Can (Bag of 14) | 6.50 in 16,5 cm | 8.00 in 20,3 cm | 1.00 gal 3,8 l | AZ8401XXC1 |
| B | Eos 1/2 gallon Watering Can (Case of 12) | 4.68 11,9 | 6.65 16,9 | 0.50 1,9 | AZ8400XXC |
| C | Eos 1 gallon Watering Can Assorted Colors (Display Box of 24) | 23.62 60,0 | 39.37 100,0 | N/A | AZ840188G |
| | Eos 1/2 gallon Watering Can Assorted Colors (Display Box of 52) | 23.62 60,0 | 39.37 100,0 | N/A | AZ840088G |

2Year
Limited
Warranty

IN-STOCK QUICK SHIP COLORS



Lime Ref: 61



Denim Ref: 52



Lava Ref: 39



Khaki Ref: 83



Assorted Color Pack Ref: 88
(Only in Case of 24 for 1 Gallon)
(Only in Case of 52 for 1/2 Gallon)



Display Box- Assorted Colors
24 Eos 1 Gallon Watering Cans or
52 Eos 1/2 Gallon Watering Cans



Crescent**TOO**

MULTIUSE BAGS



Planters and Floral

These great containers can be potted up or used in floral arrangements, but what makes them great is that they then can become a great storage container.

Gift Bags

For any event these are the best grab bags one can use, from weddings, to birthdays people will appreciate they don't have to throw them out after the contents are consumed.

Storage Containers

These multi-use containers can go from the garden shed, to the kids room, to organizing the garage, all with style.

Fashion Bags

Our large bags, are great to take to the supermarket, beach or on any trip. Just throw in anything you need and you are ready to go.

Multiuse Bags



Hold Everything:
Keep a spare in the car.



Herb Containers:
Write on them and personalize them.



Gift Bags:
Ideal for parties.

Multiuse Bags



Toy Chest



Picnic Basket



Tool Storage



Floral Arrangements



Holiday Gift Basket



Shower Caddy

Gabrielle Bags









Malachite, Denim and Mandarin



Malachite

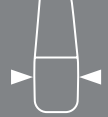

Aquamarine, Strawberry and Lime

|  | | dimensions | | | volume capacity | product ref.# |
|----------------------------------------------------------------------------------|---------------------------------|-----------------------------------------------------------------------------------|-----------------------------------------------------------------------------------|------------------------------------------------------------------------------------|-------------------------------------------------------------------------------------|-------------------------------------------------------------------------------------|
| | |  |  |  |  |  |
| A | Gabrielle Mini Bag (Case of 14) | 6.25 in 15,9 cm | 4.00 in 10,2 cm | 7.88 in 20,0 cm | N/A | AZ3801XXC |
| B | Gabrielle Bag (Case of 8) | 9.50 24,1 | 5.00 12,7 | 11.50 29,2 | N/A | AZ3802XXC |
| C | Gabrielle Big Bag (Case of 6) | 17.00 43,2 | 8.50 21,6 | 22.25 56,5 | N/A | AZ3803XXC |

2Year
Limited
Warranty

IN-STOCK QUICK SHIP COLORS



Strawberry Ref: 36



Lime Ref: 61



Aquamarine Ref: 50



Assorted Bright Color Pack Ref: 88



Mandarin Ref: 41



Malachite Ref: 68



Denim Ref: 52



Assorted Deep Color Pack Ref: 86



Crescent**TOO**

TOOLS AND
METAL BRACKETS



In-Store displays

These accessories are easy to merchandise with our ready to go display racks. We offer a variety of display options always considering smaller footprints and great visual appeal.

Great add-on sales

Our accessories complement the sale of planters in every garden center. They create a great revenue opportunity.



Innovative Tools

Our expanded line of hand tools provides a wide range of innovative products that are lightweight, durable, and rust proof.







| | | dimensions | | | | Product ref.# |
|---|--------------------------------------|--------------|----------|---------------|----------|---------------|
| | | Width | | Length | | |
| A | 3 Prong Cultivator Black (Case of 6) | 3.39 8,6 | in cm | 12.00 30,5 | in cm | BZ771294C |
| B | Cultivator Black (Case of 6) | 3.43 8,7 | | 12.00 30,5 | | BZ761294C |
| C | Weed Fork (Case of 6) | 3.25 8,3 | | 11.00 27,9 | | BZ821194C |
| D | Weed Extractor Black (Case of 6) | 1.65 4,2 | | 13.00 33,0 | | BZ781394C |
| E | Narrow Transplanter (Case of 6) | 2.50 6,4 | | 11.30 28,7 | | BZ811194C |
| F | Wide Trowel Black (Case of 6) | 3.50 8,9 | | 11.30 28,7 | | BZ801194C |
| G | Fan Rake Black (Case of 6) | 5.51 14,0 | | 15.70 39,9 | | BZ791694C |
| H | Hoe Black (Case of 4) | 7.88 20,0 | | 18.30 46,5 | | BZ751894C |
| I | Shovel Black (Case of 6) | 5.31 13,5 | | 27.50 69,9 | | BZ742794C |

| DISPLAYS | | Width | | Length | | |
|----------|-----------------------------------------------------------------------|------------------------------|----------|----------------|----------|-----------|
| A | Garden Tools and Cleo Display, with tools, watering cans and sprayers | 25.20 x 17.30 64,0 x 43,9 | in cm | 63.50 161,3 | in cm | BZ800094G |
| B | Garden Tools Display, with trowels and forks | 1.75 x 3.25 4,4 x 8,3 | | 10.75 27,3 | | BZ018894C |
| C | Garden Tools Display, with trowels only | 1.75 x 3.25 4,4 x 8,3 | | 10.75 27,3 | | BZ028894C |

Display A includes:

- 1 Cardboard Display for Tools
- 6 Shovel Black
- 12 Wide Trowel Black
- 6 Narrow Transplanter
- 4 Hoe Black
- 6 Weed Extractor Black
- 6 Weed Fork
- 6 Cultivator Black
- 6 3 Prong Cultivator Black
- 6 Fan Rake Black
- 9 Cleo Sprayer Lime
- 9 Cleo Sprayer Snow
- 10 Cleo Watering Can Assorted



Display B includes:

- 1 Cardboard Display for Tools
- 9 small trowels
- 9 large trowels
- 9 garden forks



Display C includes:

- 1 Cardboard Display for Tools
- 18 large trowels
- 9 small trowels



2Year
Limited
Warranty

Adjustable Bracket Set for Rail Planters



| | A | dimensions | | | | product ref.# |
|---|--------------------------------------------------------------|------------|---------------------|--------------------|--------|---------------|
| | | Width | Length | | Height | |
| A | Adjustable Bracket Set for Rail Planters (Case of 6 Sets) | N/A N/A | 15.75 in 18,0 cm | 7.09 in 18,0 cm | | AZ850194C |

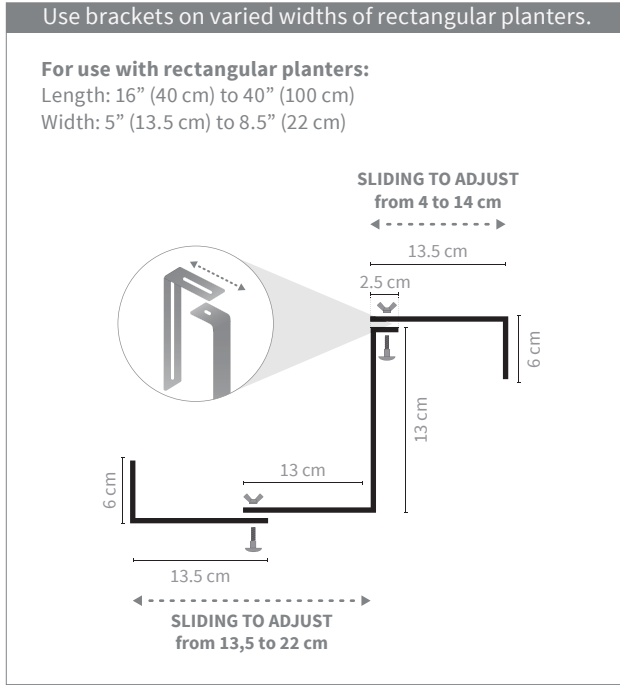



MARKETING AIDS



Great Visual Aids

We want to provide you with the tools to communicate our product attributes better. When a sales attendant is not close to your customer our banners and product platforms help communicate our product warranty, and inspire your customers.

Digital Marketing

In a digital age we realize it is important for us to provide you not only with in store visual aids but also digital content. We want you to take advantage of all our brand awareness marketing.

Creating a Home for Crescent Garden Products

Through advertising in magazines, product releases and web campaigns we promote the Crescent brands. We want the customer to make the connection inside your store.

Premier Garden Center Program

Our Premier Garden Center program gets you started with free point of purchase aids, specialized Lunch and Learn opportunities for your employees and much more. Ask your sales representative for more information on how to become a premier dealer.

In Store Videos

Request copies of our video content to run in your video displays in store. From TruDrop videos to our 360 degree sprayers we are continuously adding to our library. Make sure we provide you with the latest content.



Social Media Sharing

12 months a year we are working at promoting Crescent Garden brand awareness on our social media channel. Be sure to follow us so you can see the latest content, and share with your consumers when it is relevant to your own marketing efforts.



Event Promotions

Use our consumer network. If you have an event in your garden center related to container gardening or Crescent Garden products, be sure to let us know. We would love to share news on our social media.



Be a part of our Content

Would like to be a greater part of our content. Be sure to tag us when posting pictures with our products. Reach out to us to participate in Crescent Garden events. We invite experts like yourselves all the time into our channel.



Garden Center Signage

| | | dimensions | | Product ref.# |
|---|--------------------------------------------------------------------|-------------------------------------------------------------------------------------|-------------------------------------------------------------------------------------|-------------------------------------------------------------------------------------|
| | |  |  |  |
| A | Indoor/Outdoor, Vinyl Banner with grommets for Garden Center use | 24.00 in | 48.00 in | APOP32 |
| B | Indoor/Outdoor, Vinyl Banner with grommets for Crescent Too Dealer | 61,0 cm | 121,9 cm | APOP34 |
| C | Branded Pinch Planter 29 inch for Premier Dealer | 28.98 73,6 | 26.06 66,2 | A6774XX-1000001 |

A



B



C

- Available for qualified customers.
- **For details please consult with your representative.**

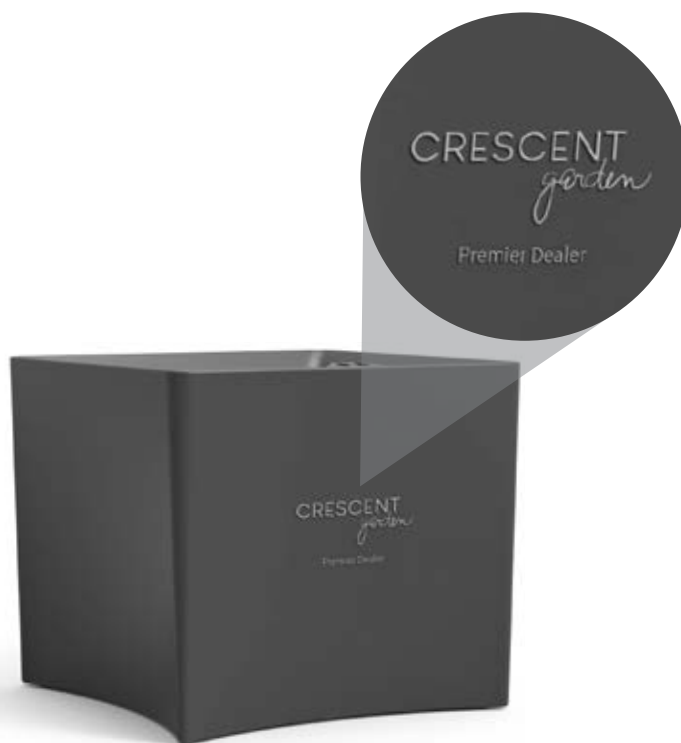

- Create awareness of product attributes in store
- Banners includes four grommets for hanging
- Water proof

IN-STOCK QUICK SHIP COLORS



Caviar Black
Ref: 94



Cloud White
Ref: 00



Ash
Ref: 98



Slate
Ref: 97



Midnight
Ref: 55



Olive
Ref: 82



Bark
Ref: 74

Crescent Garden Display Platforms

| | | dimensions | | | Product ref.# |
|---|------------------------------------------------------------------|----------------------|----------------------|--------------------|---------------|
| | | | | | |
| A | Crescent Garden European Pallet Cover Display 100 x 120 cm (2pk) | 47.24 in 120,0 cm | 39.37 in 100,0 cm | 5.00 in 12,7 cm | APOP10C |
| B | Crescent Garden European Pallet Cover Display 120 x 80 cm (2pk) | 47.24 in 120,0 cm | 31.50 in 80,0 cm | 5.00 in 12,7 cm | APOP11C |

Easy Three Step Process:



1. Use one regular european standard Pallet



2. Lay our sleeves on top and fold flaps down

READY TO SELL!





3. Place your Crescent Garden Planters on top

Color Sample Pack

| | | dimensions | | Product ref.# |
|---|-----------------------------------------------------------------------------------|-------------------|--------------------|---------------|
| | | | | |
| A | NEW Crescent Color Sample Set: Includes current color disks in every color | 3.50 in 8,9 cm | 5.25 in 13,3 cm | A83CG25 |

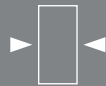

TruDrop POP Material

| | | dimensions | | |
|---|-------------------------------------------------------------|-----------------------------------------------------------------------------------|-------------------------------------------------------------------------------------|--------|
| | |  |  | |
| A | We help you grow. TruDrop Apron for Employee | N/A | N/A | APOP22 |
| B | Stand for TruDrop Banners (holds 2 back to back) | N/A | 72.00 in 182,9 cm | APOP23 |
| C | TruDrop One Diagram for Banner Stand | 3.00 ft 91,4 cm | 2.00 ft 61,0 cm | APOPXX |
| D | TruDrop One Banner for Banner Stand - Nest Planter (Family) | 3.00 ft 91,4 cm | 2.00 ft 61,0 cm | APOPXX |

A



B



C



D





we help you grow

CELEBRATING
25 YEARS

 +1 (305) 477-0024

www.crescentgarden.com

VERSION 0724