

FLEXZILLA®

PREMIUM HOSES, TOOLS & EQUIPMENT



 AIR



 WATER



 POWER



 LUBE

2024 CATALOG

If it's not ZillaGreen®, it's not Flexzilla®

Legacy™ BRANDS

FLEXZILLA® COLORS™ SMARTFLEX® ColorConnex® LOCK-N-LOAD® Workforce®



THE FLEXZILLA® EDGE

Giving you the edge you deserve.

You work hard to get where you are in life. When it's time to choose the tools that help get you there, you deserve something that's above the ordinary. Tools that give you the edge you need to complete your projects faster, easier and with more satisfaction at the end of the day. You deserve Flexzilla hoses, tools and equipment.

**It's the difference between ordinary tools
and the innovative thinking designed
into every Flexzilla product.**

We take conventional tool ideas and rethink the work experience. The result is premium air, water and power tools that pull their weight and always put you a step ahead.

Experience it for yourself.

See how the innovative details we put into our tools make all the difference. Whether you're a professional or do-it-yourselfer, working with Flexzilla tools doesn't feel like work.



FLEXZILLA[®]

by

legi



Air Compressors

Stationary Air Compressors - Pressure Lubricated	8-9	Air Compressor Accessories	11
Stationary Air Compressors - Splash Lubricated	10	Portable Air Compressors	12
Refrigerated Air Dryers	11		

Air Hoses

Air Hose Assemblies	14	Pro Air Hose Assemblies	22
Air Hose Kits	15-16	Pro Air Hose Kits	23
Whip Hose Assemblies	16	Pro Custom Length Whip Hose with High Flow Ball Swivel	23
Polyurethane Recoil Hose	17	SmartFlex® Air Hose Assemblies Hybrid Polymer Blend	77
Pro Custom Air Hose	18	SmartFlex® Air Hose Assemblies Rubber	77
Pro Custom Hose Center	19-20	Workforce® Air Hose Assemblies PVC	79
Pro Reusable Fittings and Splicers	21	Workforce® Air Hose Assemblies Rubber	79
Bulk Air and Water Hose	21	Workforce® Truck Tire Inflator Kit	79

Air Hose Reels

Pro Retractable Air Hose Reels with Levelwind™ Technology	25	Manual Air Hose Reels	31
Levelwind™ Mounting Brackets	25	Manual Air Hose Reels - Fixed, Heavy-Duty	32
Pro Retractable Air Hose Reel	26	Manual Air Hose Reels - Portable	33
Retractable Air Hose Reels	27	Lead-In Hoses	34
Retractable Air Hose Reels - Single Axle Arm Support	28	Levelwind™ Retractable Air Hose Reel	74-75
Retractable Air Hose Reels - Dual Axle Arm Support	29	Levelwind™ Lead-in Hoses and Mounting Brackets	75
Retractable Air Hose Reels - Single Arm, Open Face	30		

Air Line Accessories

Pro High Flow Couplers and Plugs	36-37	ColorConnex® Industrial Interchange Couplers and Plugs	82
Pro High Flow Coupler and Plug Kits	38	ColorConnex® Automotive Interchange Couplers and Plugs	83
Pro Heavy Duty Safety Couplers and Plugs	39	ColorConnex® ARO Interchange Couplers and Plugs	84
Pro Heavy Duty Safety Coupler and Plug Kits	40		

Blow Guns and Tire Maintenance

Modular Blow Guns	42	Truck Tire Inflator Kits	46
Modular Blow Gun Kits	42	Workforce® Blow Guns	86
Modular Blow Guns Accessories System	43	Workforce® Tire Gauge and Inflator	86
Tire Inflator	45		

Air Tools

Pro Mini Impact Wrench	48
----------------------------------	----

WATER

Water Hoses and Reels

SwivelGrip® Garden and Lead-in Hose Assemblies	50-51	Pro Water Hose Assemblies Field Repairable	61
SwivelGrip® Garden Hose Merchandiser and Pallets	51	Pro Retractable Water Hose Reel with Levelwind Technology	62
Garden and Lead-in Hose Assemblies	52	Levelwind™ Mounting Brackets	62
Colors™ SwivelGrip Garden Hose Assemblies	53-54	Pressure Washer Hose Assemblies	63
Garden Hose Kit with Quick Connect Attachments	55	SmartFlex® Garden Hose Assemblies	78
Marine Twin Outboard Flush Kit, 6-Piece	57	SmartFlex® RV/Marine Hose Assemblies	78

Nozzles, Sprinklers, Fittings, and Accessories

3-Piece Nozzle Kit with Quick Connections	55	Garden Hose Nozzles	58-60
Quick-Connect Garden Hose Fittings	56	Lawn Sprinklers	60
2-Way Hose Splitter	57	Pro Water Hose Nozzles	60

POWER

Extension Cords

Pro Extension Cords	65	Pro Retractable Extension Cord Reel	67
Retractable Extension Cord Reels	66		

LUBE

Greasing Equipment

20V Cordless Grease Gun Kit	69	Workforce™ Suction Gun	90
Lever Action Grease Gun	70	Workforce™ Grease Guns	90-92
Quick-Release Grease Coupler	70	Workforce™ Grease Couplers and Hoses	93-94
Grease Hoses	71	Workforce™ Grease Accessories, Repair Tools and Oil Pump	95
Lock-n-Load™ Grease Guns	88-89	Workforce™ Grease Fittings: Standard, Metric, and Drive	96

Plan-O-Grams & Part Number Index

Plan-O-Grams	97-108	Part Number Index	109-112
------------------------	--------	-----------------------------	---------



Flexzilla® Air Hose

FEATURES:

- Extreme all-weather flexibility, even in subzero temperatures (-40° to 140°F)
- Won't kink under pressure
- Lightweight and easy to handle
- Lays flat - no memory
- Durable and abrasion-resistant outer cover
- Anodized aircraft aluminum ends
- Max. working pressure at 70°F: 300 psi
- Includes bend restrictors to reduce wear and tear, prolonging the life of the hose



Flexzilla® Water Hose

FEATURES:

- Extreme all-weather flexibility (max. temp 140°F)
- Durable outer cover resists abrasion, UV and mold
- Won't kink under pressure
- Lightweight and easy to handle
- Lays flat - no memory
- Reinforced mid-layering provides extra strength
- Anodized aircraft aluminum ends
- Leak-free connections - A durable O-ring provides long lasting leak-free connections
- Max. working pressure at 70°F: 150 psi



ColorConnex® Couplers & Plugs

ColorConnex is a patented system that allows color-to-color matching of couplers and plugs among the standard pneumatic interchanges.

- Industrial (Type D): Red
- Automotive (Type C): Blue
- ARO (Type B): Green

By using ColorConnex to dedicate line use, you can ensure you never use a lubricated line for a dry line application, preventing cross contamination.

- Match coupler and plug types
- Dedicate hose applications



Flexzilla® Pro Air Hose

FEATURES:

- Field Repairable – Reusable anodized aircraft aluminum fittings
- Extreme all-weather flexibility, even in subzero temperatures (-40° to 140°F)
- Won't kink under pressure
- Lightweight and easy to handle
- Lays flat - no memory
- Durable and abrasion-resistant outer cover
- Max. working pressure at 70°F: 300 psi
- Flexzilla Pro Reusable Fittings include bend reinforcement to reduce wear and tear, prolonging the life of the hose



Flexzilla® Pro Water Hose

FEATURES:

- Field Repairable – Reusable anodized aircraft aluminum fittings
- Extreme all-weather flexibility (max. temp 140°F)
- Lightweight, coils easily
- Won't kink under pressure
- Lays flat - no memory
- Durable outer cover resists abrasion, UV and mold
- Reinforced mid-layering provides extra strength
- Leak free connections - A durable O-ring provides long lasting leak free connections
- Max. working pressure at 70°F: 150 psi
- Flexzilla Pro Reusable Fittings include bend reinforcement for increased flexibility. Reduces wear and tear, prolonging the life of the hose.

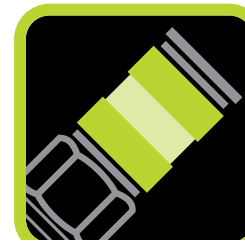

Flexzilla® Pro High Flow Couplers and Plugs

Flexzilla Pro High Flow couplers and plugs allow Twice The Flow to your air tools compared to standard interchanges. Connect Flexzilla High Flow fittings from your tool all the way to the compressor. Don't Starve Your Air Tool!

- Push-To-Connect
- Increased efficiency
- Maximum Torque
- Maximum RPM
- Best Performance
- Ideal for spray guns and impact tools

Flexzilla® Pro Heavy Duty Safety Couplers and Plugs

FEATURES:

- ZVR™ Technology - Zero Valve Restriction provides absolute throughput and feeds your tool the maximum CFM possible
- Safety Coupler - Connect and disconnect under zero pressure
- Non-marring

Flexzilla® Pro

Flexzilla Pro Products are designed with the professional in mind



Drinking Water Safe

The Flexible Hybrid Polymer inner tube material makes many of our hoses drinking water safe



QUIET TECHNOLOGY™

Quiet Technology™, which uses large, low-RPM pumps and motors to reduce high frequency noise levels while increasing CFM output.

AIR COMPRESSORS

SILENCER™ NOISE SUPPRESSION

A patented noise suppression system that uses baffles to reduce low frequency noise.



SILENCER

FLEXZILLA
PRO



QUIET
TECHNOLOGY™

Stationary Air Compressors - Pressure Lubricated



PRO

Let's face it, standard air compressors are LOUD. All this NOISE interferes with workplace communication, lowers productivity on the job, and increases risk of hearing loss. Fortunately, Flexzilla® brings quiet back to the workplace.

QUIET TECHNOLOGY™

Flexzilla air compressors are the quietest on the market, emitting operating noise no louder than a normal conversation. Flexzilla air compressors feature low RPM pumps and motors that reduce high frequency noise levels while increasing CFM output.

SILENCER™

Flexzilla stationary air compressors include the Silencer,™ a patented noise suppression system that reduces low frequency noise levels.

INDUSTRY EXCLUSIVE!

10 HP RECIPROCATING UNIT / 1-PHASE

High CFM performance without the cost of installing 3-Phase. Output of more expensive screw units without the added cost.



SILENCER™ NOISE SUPPRESSION

Patented

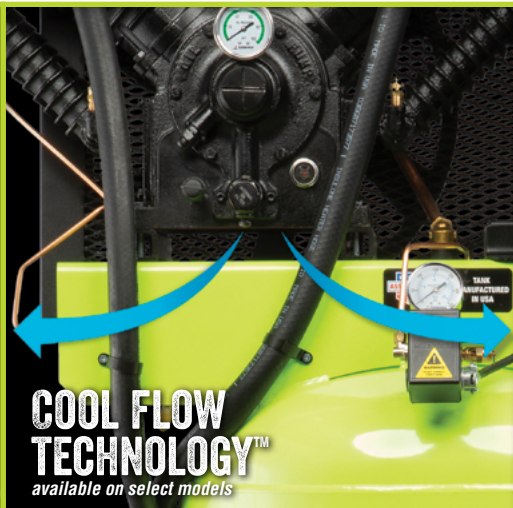
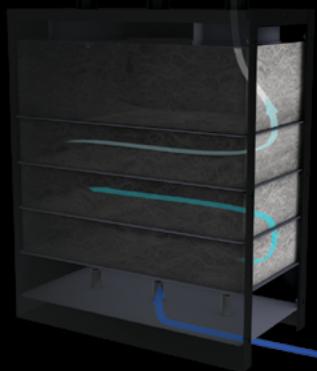

COOL FLOW TECHNOLOGY™

available on select models

10 HORSEPOWER SINGLE-PHASE

available on select models



Stationary Air Compressors - Pressure Lubricated

PRO



FLEXZILLA® PRO (5 HP) INCLUDES:

- Manual water drain
- Motor - open drip proof (ODP)
- 4 Year Warranty
 - 1 Year Parts and Labor Warranty
 - Additional 3 Year Extended Parts Warranty



FLEXZILLA® PRO (7.5 / 10 HP) INCLUDE:

- Cool Flow Technology™
- Timed water drain
- Belt tensioner
- Continuous run (Dual control)
- Totally enclosed fan cooled motor



- Magnetic starter - prewired
- Ball valve crank case oil drain
- 6 Year Warranty
 - 1 Year Parts and Labor Warranty
 - Additional 5 Year Extended Parts Warranty

Part No.	HP Spec	Tank Size (Gal.)	CFM @ 90 PSI	Max. PSI	Pump	Connection	Pump Pressure Lubed	Automatic Tank Drain	Belt Tensioner	Continuous Run	Cool Flow Technology™	Length (in.)	Width (in.)	Height (in.)	Assembled in USA	Tank Made in USA
Flexzilla® Pro Stationary Air Compressors, 5 HP																
FS05V0801	5	80	19	175	2-Cyl	1-Phase	●	-	-	-	-	42	33	75	●	●
Flexzilla® Pro Stationary Air Compressors, 7.5 HP																
FXS07V080V1	7.5	80	33	175	4-Cyl	1-Phase	●	●	●	●	●	38	42	72.5	●	●
FXS07V080V3-208	7.5	80	33	175	4-Cyl	3-Phase	●	●	●	●	●	38	42	72.5	●	●
FXS07V080V3-230	7.5	80	33	175	4-Cyl	3-Phase	●	●	●	●	●	38	42	72.5	●	●
Flexzilla® Pro Stationary Air Compressors, 10 HP																
FXS10V080V1	10	80	39	175	4-Cyl	1-Phase	●	●	●	●	●	38	42	72.5	●	●
FXS10V080V3-208	10	80	39	175	4-Cyl	3-Phase	●	●	●	●	●	38	42	72.5	●	●
FXS10V080V3-230	10	80	39	175	4-Cyl	3-Phase	●	●	●	●	●	38	42	72.5	●	●
FXS10V120V1	10	120	39	175	4-Cyl	1-Phase	●	●	●	●	●	41	43	78	●	●
FXS10V120V3-208	10	120	39	175	4-Cyl	3-Phase	●	●	●	●	●	41	43	78	●	●
FXS10V120V3-230	10	120	39	175	4-Cyl	3-Phase	●	●	●	●	●	41	43	78	●	●
Flexzilla® Pro Stationary Air Compressors, 20 HP (Alternating - 2 qty. 10 HP, 2 qty. 120 Gal. tanks)																
FXS10A120V1	20	240	78	175	4-Cyl	1-Phase	●	●	●	-	●	41	104	78	●	●
FXS10A120V3-208	20	240	78	175	4-Cyl	3-Phase	●	●	●	-	●	41	104	78	●	●
FXS10A120V3-230	20	240	78	175	4-Cyl	3-Phase	●	●	●	-	●	41	104	78	●	●

NEW

Stationary Air Compressors - Splash Lubricated



FLEXZILLA® (5 / 7.5 / 10 HP) INCLUDE:

- Motor - Open drip proof (ODP)
- Automatic tank drain
- Heavy Steel OSHA Approved Belt Guards
- 4 Year Warranty
 - 1 Year Parts and Labor Warranty
 - Additional 3 Year Extended Parts Warranty

SINGLE PHASE ONLY, 3-PHASE MOTOR IS NOT AVAILABLE FOR SPLASH UNITS

Part No.	HP Spec	Tank Size (Gal.)	CFM @ 90 PSI	Max. PSI	Pump	Connection	Pump Splash Lubed	Automatic Tank Drain	Length (in.)	Width (in.)	Height (in.)	Assembled in USA	Tank Made in USA
Flexzilla® Stationary Air Compressors, 5 HP													
FS050V80Y1	5	80	16	175	2-Cyl	1-Phase	●	●	40	39	69	●	●
Flexzilla® Stationary Air Compressors, 7.5 HP													
FS07V080Y1	7.5	80	25	175	4-Cyl	1-Phase	●	●	40	40	69	●	●
Flexzilla® Stationary Air Compressors, 10 HP													
FS10V080V1	10	80	37	175	4-Cyl	1-Phase	●	●	38	43	73	●	●
FS10V120V1	10	80	37	175	4-Cyl	3-Phase	●	●	47	44	79	●	●

Refrigerated Air Dryers

Flexzilla™ Pro Refrigerated Air Dryers continuously chill the compressed air from your compressors to condense and remove moisture, leaving only powerful, compressed air your pneumatic tools require for best performance.

FEATURES:

- Premium Industrial Refrigerated Air Dryer
 - Chills the air to condense and remove moisture; runs on 115 Volt, single phase
 - 230 PSI max.; Max. inlet temp: 140°F; 37°F - 50°F dew point
 - Maximum ambient temperature: 122°F; for use with compressors that do not have aftercoolers
- 5 Micron Pre-Filter - Removes larger dust and dirt particles from the air supply so the dryer can work more efficiently
- 1 Micron Active Coalescing Filter - Removes oil and water Particles from the air; cleaner, drier air improves tool life & project results
- Refrigerated Air Inlet Inner Cooler - Trouble-free high temperature cooling for consistent dry air
- Automatic Drain System - Eliminates the need for daily maintenance
- Outlet Air Baffle Heater - Prevents condensation on outlet air piping
- Side Mounted Condenser and Fan Motor
 - Easy to reach and service through the cabinet doors- no screws to slow you down
 - Uses environmentally friendly 134A refrigerant
- Heavy Duty Steel Cabinet and Safety Shut-Off Valve - Meets the demands of industrial use; valve shuts the compressor down if it gets above or below a safe temperature



Part No.	Volt	CFM	HP Spec	Max. PSI	Inlet Fittings	Outlet Fittings
FDRCF1150030	115V	30	5 HP-7.5 HP	230 PSI	1/2 in. NPT	1/2 in. NPT
FDRCF1150058	115V	58	10 HP	230 PSI	1/2 in. NPT	1/2 in. NPT
FDRCF1150115	115V	115	15-25HP	230 PSI	1/2 in. NPT	1/2 in. NPT

NEW

Air Compressor Accessories

Part No.	Description	Retail Packaging	Assembled in USA
DRAIN013	Flexzilla™ Pro Air Compressor Timed Water Drain	-	-
FILTER057	Flexzilla™ Air Compressors Air Filter for 5-10 HP	-	●
FILTER107KIT	Flexzilla™ Air Compressor Silencer™ Filter Replacements, Qty. 8	-	●
FILTERKIT011	Flexzilla™ Air Dryer Filter Maintenance Kit, for 30 CFM	-	-
FILTERKIT012	Flexzilla™ Air Dryer Filter Maintenance Kit, for 58 CFM	-	-
FKIT008AWB	Smart Oil™ and Filter Maintenance Kit, 12-Piece, for 5-10 HP Air Compressors	-	-
FKIT011A	Flexzilla™ Air Dryer Filter Maintenance Kit, for 30 CFM	-	-
FKIT026A	Smart Oil™ and Filter Maintenance Kit, 24-Piece, for 5-10 HP Air Compressors	-	-
ISOLATORS001	Flexzilla™ Air Compressors Isolator Pads, Qty. 4	-	-
MAINKIT008A	Flexzilla™ Air Compressors Oil and Filter Maintenance Kit, for 5-10 HP	-	●
OILFZ004	Flexzilla™ Air Compressor Oil, Synthetic, Piston-Type, 1 Qt.	●	●
OILPIS102Q	Smart Oil™ Whisper Blue Air Compressor Oil, Synthetic, 1 Qt.	●	●



FILTER057



DRAIN013



FILTER107KIT



FILTERKIT011

Portable Air Compressors



QUIET TECHNOLOGY™

Flexzilla® Air Compressors are the quietest on the market, emitting operating noise no louder than a normal conversation. Flexzilla Air Compressors feature low RPM twin cylinder pumps and motors that reduce high frequency noise levels.



CF10050F

1 HP / 5 GAL.

FEATURES:

- Industrial Grade Pump
 - Premium components and copper windings that outlast aluminum
- Direct Drive Pump
- Oil-Free Pump
 - Reduces Maintenance
- Two Quick-Connect Universal Couplers
- Pressure Regulator and Gauge
- Tank Pressure Gauge
- Manual Tank Drain
- Elastomeric Ergonomic Grip

Brass



CB20100F

2 HP / 10 GAL.

CF10050F FEATURES:

- Convenient top mounted controls

CB20100F & CB20200F FEATURES:

- Front mounted controls
- 8 in. oversize wheels - for ease of mobility



CB20200F

2 HP / 20 GAL.

Part No.	HP Spec	Tank Size	CFM @ 90 PSI	Max. PSI	Pump RPM	Pump	Power Source	Current Draw / Max. Amps	Oil-Free Pump	Direct Drive Pump	Retail Packaging
Flexzilla® Portable Air Compressors, 1 HP											
CF10050F	1 HP	5 Gal.	2.5 CFM	125 PSI	1702 RPM	2-Cyl	ELECTRIC	7 AMPS @ 115V	●	●	●
Flexzilla® Portable Air Compressors, 2 HP											
CB20100F	2 HP	10 Gal.	5.8 CFM	125 PSI	1740 RPM	2-Cyl	ELECTRIC	14 AMPS @ 115V	●	●	●
CB20200F	2 HP	20 Gal.	5.8 CFM	125 PSI	1740 RPM	2-Cyl	ELECTRIC	14 AMPS @ 115V	●	●	●

FLEXIBLE HYBRID POLYMER

Flexzilla® hoses have a durable, abrasion-resistant outer cover.

WON'T KINK UNDER PRESSURE

Lightweight and easy to handle, Flexzilla hoses lay flat, have no memory and won't kink under pressure.

AIR HOSES

EXTREME ALL-WEATHER FLEXIBILITY

Flexzilla hoses offer extreme all-weather flexibility, even in subzero temperatures (-40° to 140°F).



Air Hose Assemblies



Flexzilla® is a revolutionary hose featuring a Flexible Hybrid Polymer material that redefines flexibility. This engineered polymer-blend material permits use in environments where general purpose PVC and rubber hose may become too stiff. Flexzilla hose characteristics offer zero memory allowing it to lay flat. It won't work against you during operation and coils easily after use. Flexzilla offers extreme all-weather flexibility, even in subzero conditions, and is ideal in both hot and cold environments where tight radius bends are needed.



HFZ3850YW2

FEATURES:

- Extreme all-weather flexibility, even in subzero temperatures (-40° to 140°F)
- Won't kink under pressure
- Lightweight and easy to handle
- Lays flat - no memory
- Durable and abrasion-resistant outer cover
- Anodized aircraft aluminum ends
- Max. working pressure at 70°F: 300 psi
- Includes bend restrictors to reduce wear and tear, prolonging the life of the hose

ASSEMBLED IN USA
of US and global components



HFZ3850YW2



HFZ3850YW2-3X

Part No.	I.D.	Length	Fittings	Packaging Type	Assembled in USA
HFZ1425YW2	1/4 in.	25 ft.	1/4 in. MNPT	●	●
HFZ1450YW2	1/4 in.	50 ft.	1/4 in. MNPT	● ●	●
HFZ14100YW2	1/4 in.	100 ft.	1/4 in. MNPT	●	●
HFZ14100YW2-3X*	1/4 in.	100 ft.	1/4 in. MNPT	●	●
HFZ3825YW2	3/8 in.	25 ft.	1/4 in. MNPT	● ●	●
HFZ3835YW2	3/8 in.	35 ft.	1/4 in. MNPT	●	●
HFZ3850YW2	3/8 in.	50 ft.	1/4 in. MNPT	● ●	●
HFZ3850YW2-3X*	3/8 in.	50 ft.	1/4 in. MNPT	●	●
HFZ3850YW3	3/8 in.	50 ft.	3/8 in. MNPT	-	●
HFZ38100YW2	3/8 in.	100 ft.	1/4 in. MNPT	● ●	●
HFZ1225YW3	1/2 in.	25 ft.	3/8 in. MNPT	●	-
HFZ1250YW3	1/2 in.	50 ft.	3/8 in. MNPT	●	-
HFZ1250YW4	1/2 in.	50 ft.	1/2 in. MNPT	-	-
HFZ12100YW3	1/2 in.	100 ft.	3/8 in. MNPT	●	-
HFZ12100YW4	1/2 in.	100 ft.	1/2 in. MNPT	-	-

*Part nos. with -3X suffix includes 3 hose assemblies respectively in a retail merchandiser display

● Retail packaging (English only)

● Individually boxed no retail packaging with suffix -E

● Retail Packaging with suffix -CA (English/French)

Air Hose Kits – Include Hose, Coupler, and Plug



This convenient hose kit features the revolutionary Flexzilla® air hose paired with a Red Industrial (Type D) 1/4 in. body ColorConnex® coupler and plug set (one each). Combining Flexzilla's revolutionary design and the convenient color coding of ColorConnex, you get two great products in one. Plus, since thread sealer is already installed on the coupler and plug, you're ready to go as soon as you reach the jobsite.



HFZ3850YW2-D

KIT INCLUDES:

- Flexzilla Air Hose
- ColorConnex Red Industrial (Type D) Coupler and Plug
- Pre-Sealed Threads



HFZ3850YW2-D

FEATURING:

Use color to:

ColorConnex®
TYPE D / INDUSTRIAL

- Match coupler & plug types
- Dedicate hose applications



Part No.	I.D.	Length	Fittings	Retail Packaging
HFZ1425YW2-D	1/4 in.	25 ft.	1/4 in. MNPT	●
HFZ1450YW2-D	1/4 in.	50 ft.	1/4 in. MNPT	●
HFZ14100YW2-D	1/4 in.	100 ft.	1/4 in. MNPT	●
HFZ3825YW2-D	3/8 in.	25 ft.	1/4 in. MNPT	●
HFZ3835YW2-D	3/8 in.	35 ft.	1/4 in. MNPT	●
HFZ3850YW2-D	3/8 in.	50 ft.	1/4 in. MNPT	●
HFZ38100YW2-D	3/8 in.	100 ft.	1/4 in. MNPT	●

Air Hose Kit – Includes Hose, Blow Gun and Accessories



KIT INCLUDES:

- (1) Flexzilla Air Hose, 50 ft. x 3/8 in.
- (1) Blow Gun with safety tip
- (1) Ball Foot Chuck
- (1) Pencil Tire Pressure Gauge (10 to 100 psi)
- (1) Coupler, 1/4 in. FNPT
- (1) Coupler, 1/4 in. MNPT
- (2) Plugs, 1/4 in. FNPT
- (3) Plugs, 1/4 in. MNPT

ASSEMBLED IN USA
of US and global components



HFZCLB11D



HFZCLB11D

Part No.	I.D.	Length	Fittings	Retail Packaging	Assembled in USA
HFZCLB11D	3/8 in.	50 ft.	1/4 in. NPT	●	●
HFZCLB11D-3X	3/8 in.	50 ft.	1/4 in. NPT	●	●

Part no. with a -3X suffix include 3 hose assemblies in a retail merchandiser display

Whip Hose Assemblies



WHY USE A WHIP HOSE?

- Increased longevity of the main hose
- Reduces user fatigue by eliminating weight of coupler/plug
- Increases mobility in tight spaces
- Improves air tool ergonomics

ASSEMBLED IN USA
of US and global components



HFZ3806YW2B

Part No.	I.D.	Length	Fittings	Retail Packaging	Assembled in USA
HFZ1405YW2B	1/4 in.	5 ft.	1/4 in. MNPT Ball Swivel x 1/4 in. FNPT	–	●
HFZ3802YW2B	3/8 in.	2 ft.	1/4 in. MNPT Ball Swivel x 1/4 in. FNPT	●	●
HFZ3804YW2B	3/8 in.	4 ft.	1/4 in. MNPT Ball Swivel x 1/4 in. FNPT	●	●
HFZ3806YW2B	3/8 in.	6 ft.	1/4 in. MNPT Ball Swivel x 1/4 in. FNPT	●	●
HFZ1202YW3S	1/2 in.	2 ft.	3/8 in. MNPT Swivel x 3/8 in. MNPT	–	–
HFZ1204YW3S	1/2 in.	4 ft.	3/8 in. MNPT Swivel x 3/8 in. MNPT	–	–
HFZ1206YW3S	1/2 in.	6 ft.	3/8 in. MNPT Swivel x 3/8 in. MNPT	–	–
HFZ1208YW3S	1/2 in.	8 ft.	3/8 in. MNPT Swivel x 3/8 in. MNPT	–	–
HFZ1202YW4S	1/2 in.	2 ft.	1/2 in. MNPT Swivel x 1/2 in. MNPT	–	–
HFZ1204YW4S	1/2 in.	4 ft.	1/2 in. MNPT Swivel x 1/2 in. MNPT	–	–
HFZ1206YW4S	1/2 in.	6 ft.	1/2 in. MNPT Swivel x 1/2 in. MNPT	–	–

Polyurethane Recoil Hose

The Flexzilla® revolution continues with the Flexzilla polyurethane recoil air hose. Flexzilla recoil air hose exhibits extreme, all-weather flexibility and outperforms nylon hose. Plus, with the field repairable fittings, damaged hose can be repaired quickly, using tools commonly available on the jobsite.

FEATURES:

- Extreme all-weather flexibility (-40° to 165°F)
- Polyurethane outperforms nylon:
 - More flexible
 - Will not become brittle over time
 - Better recoil memory
- Working pressure at 70°F: 120 psi
- 1/4 in. MNPT reusable ends
- Safety factor: 3:1
- Tool end: 16 in. tail with swivel fitting
- Compressor end: 8 in. tail with rigid fitting
- Pre-applied thread sealer

Part No.	I.D.	Length	Fittings	Packaging Type
LP1410AFZ	1/4 in.	10 ft.	1/4 in. MNPT	● ●
LP1415AFZ	1/4 in.	15 ft.	1/4 in. MNPT	● ●
LP1420AFZ	1/4 in.	20 ft.	1/4 in. MNPT	● ●
LP1425AFZ	1/4 in.	25 ft.	1/4 in. MNPT	● ●
● Retail packaging (English only)				
● Individually boxed no retail packaging with suffix -E				



LP1425AFZ



LP1410AFZ



LP1415AFZ



LP1420AFZ

Flexzilla® Pro Air Hose

Flexzilla® Pro Air Hose is available in pre-assembled coils or in our Custom Hose Centers where the end user can fabricate a custom length hose for any application. The field repair and custom length hose process takes

3 EASY STEPS

✓ CUSTOM LENGTHS



1
CUT – Measure and cut desired length of hose at 90° angle.



2
INSTALL – Slide spiral fitting and nut onto hose. Push hose onto fitting until hose reaches threads.



3
TIGHTEN – Tighten fitting nut until snug. Slide bend restrictor up and snap onto nut.

✓ FIELD REPAIRABLE

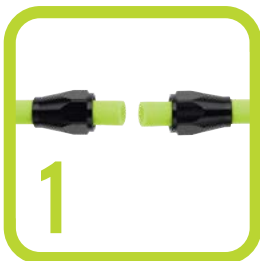

1
CUT – Cut damaged portion of hose at 90° angle. Slide fitting nuts onto hose.



2
INSTALL – Slide hose onto fitting until hose reaches threads.



3
TIGHTEN – Tighten fitting nuts until snug.

Custom Hose Center



The Flexzilla® Pro Custom Hose Center allows you to provide your customers with custom length hose assemblies. Using Flexzilla Pro reusable ends, you can quickly and easily create custom length hose assemblies on site.



Custom Hose Center (continued)



HFZBRP1 - Flexzilla® Pro Custom Hose Center		
Part No.	Description	Rack Quantity
HFZ12250YW	Flexzilla® Pro Air Hose, 1/2 in. x 250 ft. Spool	1 ea.
HFZ14250YW	Flexzilla® Pro Air Hose, 1/4 in. x 250 ft. Spool	2 ea.
HFZ38250YW	Flexzilla® Pro Air Hose, 3/8 in. x 250 ft. Spool	2 ea.
HFZW58250YW	Flexzilla® Pro Water Hose, 5/8 in. x 250 ft. Spool	1 ea.
RP900250	Flexzilla® Pro Air Hose Reusable Fitting, 1/4 in.	10 ea.
RP900250BS	Flexzilla® Pro Air Hose Reusable Fitting with Ball Swivel, 1/4 in.	10 ea.
RP900375	Flexzilla® Pro Air Hose Reusable Fitting, 3/8 in.	10 ea.
RP900375BS	Flexzilla® Pro Air Hose Reusable Fitting with Ball Swivel, 3/8 in.	10 ea.
RP900500	Flexzilla® Pro Air Hose Reusable Fitting, 1/2 in.	10 ea.
RP900500S	Flexzilla® Pro Air Hose Reusable Fitting with Swivel, 1/2 in.	10 ea.
RP900625F	Flexzilla® Pro Water Hose Female Reusable Fitting, 5/8 in.	10 ea.
RP900625M	Flexzilla® Pro Water Hose Male Reusable Fitting, 5/8 in.	10 ea.
RP901250	Flexzilla® Pro Air Hose Reusable Splicer, 1/4 in.	10 ea.
RP901375	Flexzilla® Pro Air Hose Reusable Splicer, 3/8 in.	10 ea.
RP901500	Flexzilla® Pro Air Hose Reusable Splicer, 1/2 in.	10 ea.
HR-05	Custom Hose Center (Freestanding Rack)	1 ea.

Parts also sold separately in standard pack quantities



HFZ12250YW



HFZ14250YW



HFZ38250YW

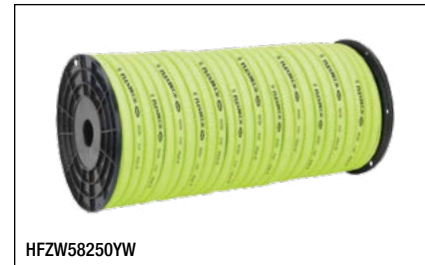

HFZW58250YW

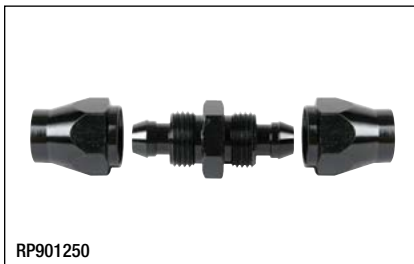

RP901250

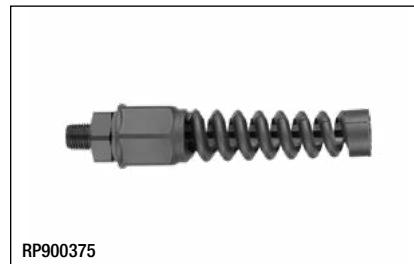

RP900375



RP901375



RP900375BS

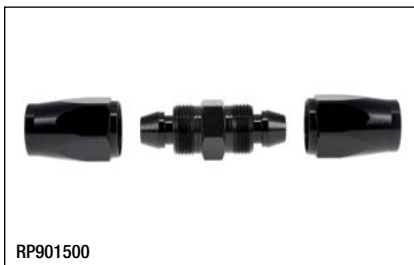

RP901500

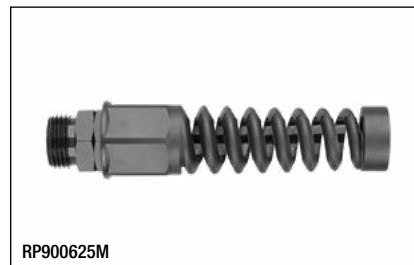

RP900625M

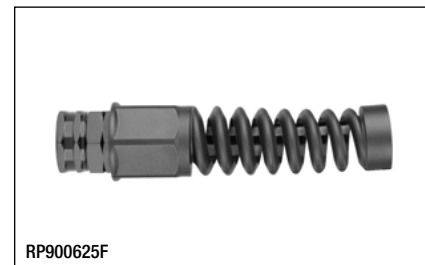

RP900625F

Reusable Fittings and Splicers – Air and Water Hose



Flexzilla® Pro Reusable Fittings and Splicers allow you to quickly repair Flexzilla hose on the jobsite, or create a custom length hose in just three easy steps.

Splicers Include:

- Reusable MNPT anodized aircraft aluminum fitting for Flexzilla and Flexzilla Pro Air Hose



Part No.	Description	Application	Fitting	Barb Size	Retail Packaging
RP900250	Reusable Fitting	Air	1/4 in. MNPT	1/4 in.	●
RP900250BS	Reusable Ball Swivel Fitting	Air	1/4 in. MNPT	1/4 in.	●
RP900250S	Reusable Swivel Fitting	Air	1/4 in. MNPT	1/4 in.	●
RP900375	Reusable Fitting	Air	1/4 in. MNPT	3/8 in.	●
RP900375BS	Reusable Ball Swivel Fitting	Air	1/4 in. MNPT	3/8 in.	●
RP900375S	Reusable Swivel Fitting	Air	1/4 in. MNPT	3/8 in.	●
RP900500	Reusable Fitting	Air	3/8 in. MNPT	1/2 in.	●
RP900500S	Reusable Ball Swivel Fitting	Air	3/8 in. MNPT	1/2 in.	●
RP901250	Hose Splicer	Air	–	1/4 in.	●
RP901375	Hose Splicer	Air	–	3/8 in.	●
RP901500	Hose Splicer	Air	–	1/2 in.	●
RP900625F	Reusable Fitting	Water	3/4 in. Female GHT	5/8 in.	●
RP900625M	Reusable Fitting	Water	3/4 in. Male GHT	5/8 in.	●

Bulk Air and Water Hose



Flexzilla® Pro bulk hose spools allow you to create custom length hose.



Part No.	Application	I.D.	Length	Fittings	Max. Working Pressure	Retail Packaging
HFZ14250YW	Air	1/4 in.	250 ft.	Sold separately	300 psi	–
HFZ38250YW	Air	3/8 in.	250 ft.	Sold separately	300 psi	–
HFZ12250YW	Air	1/2 in.	250 ft.	Sold separately	300 psi	–
HFZW58250YW	Water	5/8 in.	250 ft.	Sold separately	150 psi	–

Air Hose Assemblies - Field Repairable



Flexzilla® Pro Field Repairable Air Hose features extreme all-weather flexibility, rugged durability and won't kink under pressure. Its unique Flexible Hybrid Polymer material redefines flexibility. With reusable anodized aircraft aluminum fittings, the Flexzilla Pro Air Hose can be repaired on the jobsite in a few simple steps.



HFZP3850YW2

FEATURES:

- **Field Repairable** – Reusable anodized aircraft aluminum fittings
- Extreme all-weather flexibility, even in subzero temperatures (-40° to 140°F)
- Won't kink under pressure
- Lightweight and easy to handle
- Lays flat - no memory
- Durable and abrasion-resistant outer cover
- Max. working pressure at 70°F: 300 psi
- Flexzilla Pro Reusable Fittings include bend reinforcement to reduce wear and tear, prolonging the life of the hose



HFZP38100YW2

Part No.	I.D.	Length	Fittings	Retail Packaging
HFZP1425YW2	1/4 in.	25 ft.	1/4 in. MNPT	●
HFZP1450YW2	1/4 in.	50 ft.	1/4 in. MNPT	●
HFZP14100YW2	1/4 in.	100 ft.	1/4 in. MNPT	●
HFZP3825YW2	3/8 in.	25 ft.	1/4 in. MNPT	●
HFZP3835YW2	3/8 in.	35 ft.	1/4 in. MNPT	●
HFZP3850YW2	3/8 in.	50 ft.	1/4 in. MNPT	●
HFZP38100YW2	3/8 in.	100 ft.	1/4 in. MNPT	●

3 EASY STEPS

FIELD REPAIRABLE



1

CUT – Measure and cut desired length of hose at 90° angle.

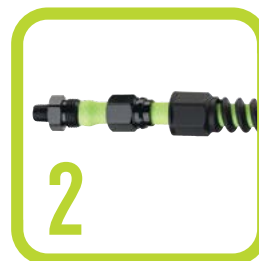

2

INSTALL – Slide spiral fitting and nut onto hose. Push hose onto fitting until hose reaches threads.



3

TIGHTEN – Tighten fitting nut until snug. Slide bend restrictor up and snap onto nut.

Air Hose Kits – Include Hose, Coupler and Plug



This convenient hose kit features the revolutionary Flexzilla® Pro Flexible Hybrid Polymer air hose paired with a Red Industrial (Type D) ColorConnex® Coupler and Plug Set (one each). Combining Flexzilla's revolutionary design and the convenient color coding of ColorConnex, you get two great products in one. Plus, since the thread sealer is already installed on the coupler and plug, you're ready to go as soon as you reach the jobsite.

KIT INCLUDES:

- Flexzilla Pro Air Hose
- ColorConnex Red Industrial (Type D) Coupler and Plug
- Pre-sealed Threads

Part No.	I.D.	Length	Fittings	Retail Packaging
HFZP1425YW2-D	1/4 in.	25 ft.	1/4 in. MNPT	●
HFZP1450YW2-D	1/4 in.	50 ft.	1/4 in. MNPT	●
HFZP14100YW2-D	1/4 in.	100 ft.	1/4 in. MNPT	●
HFZP3825YW2-D	3/8 in.	25 ft.	1/4 in. MNPT	●
HFZP3850YW2-D	3/8 in.	50 ft.	1/4 in. MNPT	●
HFZP38100YW2-D	3/8 in.	100 ft.	1/4 in. MNPT	●

FEATURING: **ColorConnex®** TYPE D / INDUSTRIAL

Use color to:

- Match coupler & plug types
- Dedicate hose applications



HFZP1425YW2-D

Custom Length Whip Hose with High Flow Ball Swivel



MEASURE - CUT - ASSEMBLE

0ft - - - - - 2ft - - - - - 4ft - - - - - 6ft

WHY USE A WHIP HOSE?

- Increased longevity of the main hose
- Reduces user fatigue by eliminating weight of coupler/plug
- Increases mobility in tight spaces
- Improves air tool ergonomics



HFZP3806YW2B

Part No.	I.D.	Length	Fittings	Retail Packaging
HFZP3806YW2B	3/8 in.	6 ft.	1/4 in. MNPT High Flow Ball Swivel and Reusable Fitting (RP900375)	●

AIR HOSE REELS



LEVELWIND™ TECHNOLOGY

Automatically layers the hose back and forth across the reel.

LATCHING MODE SWITCH

Latch hose every three feet for extended use or switch to free run for immediate, automatic rewinding.

Retractable Air Hose Reels with Levelwind™ Technology



Featuring Levelwind™ – Flexzilla’s unique winding system that automatically layers hose back and forth across the reel ensuring that the hose is coiled smoothly, easily...every time – and includes Flexzilla® air hose and lead-in hose.

Available options:

- 3/8 in. x 50 ft.
- 3/8 in. x 75 ft.
- 1/2 in. x 50 ft.



Levelwind™ Technology
Layers the hose evenly, easily...every time!

FEATURES:

- **Latching Mode Switch** - Choose from latching hose every 3 ft. for extended use or switch to free run for immediate automatic rewinding
- **Seven Position Locking Bracket** - These reels can swivel freely on a mounting bracket up to 135° or can be locked into place using the locking brace. Up to seven different locking angles can be utilized (L8300-W)
- **Adjustable Hose Stopper** - Increase or decrease the length of the hose that remains when hose is fully retracted
- **Extra Large Swivel** - A 3/4 in. swivel reduces flow restrictions and allows for maximum flow
- **Freestanding Base** - Portable - Use freestanding or mounted on wall or ceiling. Flat base allows reel to rest on the ground
- **Built-In Handle** - For carrying ease
- **Durable Construction** - Made from durable UV stabilized polypropylene
- **Hose Material** - Flexible Hybrid Polymer
- **Lead-in Hose Included** - 5 ft.

ASSEMBLED IN USA
of US and global components

Retractable Air Hose Reels with Levelwind™ Technology

Part No.	I.D.	Length	Working Pressure @ 70°F	Temperature Range (F°)	Lead-in Hose Connection	Reel Inlet	Hose Outlet	Weight	Retail Packaging	Assembled in USA
L8305FZ	3/8 in.	50 ft.	300 psi	-40° to 140°	3/4 in. Female GHT x 1/4 in. MNPT	3/4 in. – 1 1/2 Male GHT	1/4 in. MNPT	25 lbs.	●	●
L8306FZ	3/8 in.	75 ft.	300 psi	-40° to 140°	3/4 in. Female GHT x 1/4 in. MNPT	3/4 in. – 1 1/2 Male GHT	1/4 in. MNPT	30 lbs.	●	●
L8335FZ	1/2 in.	50 ft.	300 psi	-40° to 140°	3/4 in. Female GHT x 3/8 in. MNPT	3/4 in. – 1 1/2 Male GHT	3/8 in. MNPT	29 lbs.	●	●

● Retail packaging (English/French)



L8305FZ Retail Package

Mounting Brackets

See page 73 for mounting bracket features.



L8300-B

L8300-W

Retractable Air Hose Reel



The Flexzilla® Pro Retractable Air Hose Reel comes pre-loaded with 50 feet of 3/8 in. Made in USA Flexzilla Air Hose. The reel features a self-leveling system which layers the hose evenly when rewinding. The auto retract/latch hose mechanism automatically locks the hose in place in 17 in. intervals. The swivel mounting bracket allows the reel to pivot in the direction of your work. The impact resistant reel housing protects and stores the air hose when not in use. This retractable reel is ideal for commercial and industrial use.



L8251FZP

HOSE I.D.	WORKING PRESSURE
3/8 IN.	150 PSI

FEATURES:

- **Self-leveling System** - Winds the hose evenly
- **Auto Retract/Latch Hose Mechanism** - Reel automatically locks hose in place at 17 in. intervals
- **Adjustable Hose Stopper** - Increase or decrease the length of the hose that remains when hose is fully retracted
- **Swivel Mounting Bracket** - Pivots in the direction of your work, reel can be mounted to wall or ceiling
- **Impact Resistant Housing**
- **Lead-in Hose Included** - 5 ft. x 1/4 in. MNPT

ASSEMBLED IN USA
of US and global components



L8251FZP

Retractable Air Hose Reel

Part No.	I.D.	Length	Working Pressure @ 70°F	Temperature Range (F°)	Lead-in Hose Connection	Hose Outlet	Weight	Retail Packaging
L8251FZP	3/8 in.	50 ft.	150 psi	-40° to 140°	1/4 in. MNPT	1/4 in. MNPT	16 lbs.	●

● Retail packaging (English/French)

Retractable Air Hose Reels



These economical, retractable air hose reels are ideal for the home shop.



L8232FZ

HOSE I.D.	WORKING PRESSURE
3/8 IN.	150 PSI

L8232FZ FEATURES:

- **Automatic Leveling System** - Layers the hose evenly when rewinding
- **Multipoint Latch Mechanism** - Reel will automatically lock hose in place at any length wherever you stop
- **Impact Resistant Housing**
- **Speed Control Device** - Provides consistent and safe speed when retracting the hose
- **Adjustable Hose Stopper** - Increase or decrease the length of the hose that remains when hose is fully retracted
- **Swivel Mounting Bracket** - Pivots in the direction of your work, reel can be mounted to wall or ceiling
- **Lead-in Hose Included** - 3 ft. x 1/4 in. MNPT



L8250FZ

HOSE I.D.	WORKING PRESSURE
3/8 IN.	150 PSI

L8250FZ FEATURES:

- **Auto Retract/Latch Hose Mechanism** - Simplifies every job by keeping excess hose out of the work space
- **Positive Latching Mechanism** - Locks hose automatically in 18 in. intervals
- **Durable Construction** - Made from durable UV stabilized polypropylene
- **Adjustable Hose Stopper** - Increase or decrease the length of the hose that remains when hose is fully retracted
- **Swivel Mounting Bracket** - Pivots in the direction of your work, reel can be mounted to wall or ceiling
- **Lead-in Hose Included** - 3 ft. x 1/4 in. MNPT

Retractable Air Hose Reels

Part No.	I.D.	Length	Working Pressure @ 70°F	Temperature Range (F°)	Lead-in Hose Connection	Hose Outlet	Weight	Retail Packaging
L8232FZ	3/8 in.	30 ft.	150 psi	-40° to 140°	1/4 in. MNPT	1/4 in. MNPT	13 lbs.	●
L8250FZ	3/8 in.	50 ft.	150 psi	-40° to 140°	1/4 in. MNPT	1/4 in. MNPT	17 lbs.	●

● Retail packaging (English/French)

Retractable Air Hose Reels – Single Axle Arm Support



These retractable, open face hose reels are ideal for indoor shop, mobile and industrial applications.



L8611FZ

HOSE I.D.	WORKING PRESSURE
3/8 IN.	300 PSI

FEATURES:

- **Multi-Position Guide Arm** - Allows mounting on wall, tank or overhead
- **Durable Heavy-Duty Steel Construction** - Provides strength and stability to the reel and bracket
- **Corrosion-Resistant Powder Coating** - Provides extra measure of protection against the elements
- **Four-Way Direction Rollers** - Allow the hose to be easily pulled from the reel
- **Self-Locking Fasteners** - Stay tight even in mobile installations
- **Narrow Size** - Ideal for easy placement and storage
- **Multi-Position Release Ratchet** - Allows appropriate amount of hose to be extended for each jobsite
- **Metal Latching Pawl** - Makes an audible clicking sound allowing the latching zone to be locked quickly and easily
- **Fully-Enclosed Spring Motor** - Packed with grease for extended life
- **Hose Material** - Flexible Hybrid Polymer
- **Lead-in Hose Included** - 5 ft.

ASSEMBLED IN USA
of US and global components



L8611FZ

Retractable Air Hose Reels – Single Axle Arm Support

Part No.	I.D.	Length	Working Pressure @ 70°F	Temperature Range (F°)	Lead-in Hose Connection	Reel Inlet	Hose Outlet	Weight	Retail Packaging	Assembled in USA
L8603FZ	3/8 in.	25 ft.	300 psi	-40° to 140°	1/4 in. MNPT x 1/4 in. MNPT	1/4 in. FNPT	1/4 in. MNPT	25 lbs.	–	●
L8611FZ	3/8 in.	50 ft.	300 psi	-40° to 140°	3/8 in. MNPT Swivel x 1/4 in. MNPT	3/8 in. FNPT Swivel	1/4 in. MNPT*	40 lbs.	●	–

*1/4 in. MNPT x 3/8 in. bushing included

● Retail packaging (English/French)

Retractable Air Hose Reels – Dual Axle Arm Support



Featuring dual axle arm support, these retractable open face hose reels can withstand constant vibration making them ideal for mobile installations.



L8711FZ

HOSE I.D.	WORKING PRESSURE
3/8 IN.	300 PSI



L8741FZ

HOSE I.D.	WORKING PRESSURE
1/2 IN.	300 PSI

FEATURES:

- **Multi-Position Release Ratchet** - Allows appropriate amount of hose to be extended for each jobsite
- **Durable Heavy-Duty Steel Construction** - Provides strength and stability to the reel
- **Corrosion-Resistant Powder Coating** - Provides extra measure of protection against the elements
- **Four-Way Direction Rollers** - Allow the hose to be easily pulled from the reel
- **Self-Locking Fasteners** - Stay tight even in mobile installations
- **Narrow Size** - Ideal for easy placement and storage
- **Multi-Position Guide Arm** - Allows mounting on wall, truck, tank or overhead
- **Galvanized Dual Support Arms and Bases** - Resist rust and corrosion
- **Dual Axle Arm Support** - Can withstand the constant vibration of mobile installations
- **Hose Material** - Flexible Hybrid Polymer
- **Lead-in Hose Included** - 5 ft.

ASSEMBLED IN USA
of US and global components

Retractable Air Hose Reels – Dual Axle Arm Support

Part No.	I.D.	Length	Working Pressure @ 70°F	Temperature Range (F°)	Lead-in Hose Connection	Reel Inlet	Hose Outlet	Weight	Retail Packaging	Assembled in USA
L8711FZ	3/8 in.	50 ft.	300 psi	-40° to 140°	3/8 in. MNPT Swivel x 1/4 in. MNPT	3/8 in. MNPT Swivel	3/8 in. MNPT	39 lbs.	-	●
L8741FZ	1/2 in.	50 ft.	300 psi	-40° to 140°	3/8 in. MNPT x 3/8 in. MNPT Swivel	3/8 in. MNPT	3/8 in. MNPT	44 lbs.	-	●

Retractable Air Hose Reels – Single Arm, Open Face



Built with quality and durability in mind, these reels incorporate heavy gauge steel and corrosion-resistant components to withstand the harsh conditions in the workplace.



L8011FZ

HOSE I.D.	WORKING PRESSURE
3/8 IN.	300 PSI



L8041FZ

HOSE I.D.	WORKING PRESSURE
1/2 IN.	300 PSI

FEATURES:

- **Multi-Position Release Ratchet** - Allows appropriate amount of hose to be extended for each jobsite
- **Durable Heavy-Duty Steel Construction** - Provides strength and stability to the reel
- **Corrosion-Resistant Powder Coating** - Provides extra measure of protection against the elements
- **Self-Locking Fasteners** - Stay tight even in mobile installations

- **Narrow Size** - Ideal for easy placement and storage
- **Multi-Position Guide Arm** - Allows mounting on wall, tank, overhead, bench, or vehicle
- **Hose Material** - Flexible Hybrid Polymer
- **Lead-in Hose Included** - 5 ft.



Retractable Air Hose Reels – Single Arm, Open Face

Part No.	I.D.	Length	Working Pressure @ 70°F	Temperature Range (F°)	Lead-in Hose Connection	Reel Inlet	Hose Outlet	Weight	Retail Packaging	Assembled in USA
L8011FZ	3/8 in.	50 ft.	300 psi	-40° to 140°	3/8 in. MNPT Swivel x 3/8 in. MNPT	3/8 in. MNPT Swivel	3/8 in. MNPT	32 lbs.	-	●
L8041FZ	1/2 in.	50 ft.	300 psi	-40° to 140°	1/2 in. MNPT Swivel x 1/2 in. MNPT	1/2 in. MNPT Swivel	1/2 in. MNPT	33 lbs.	-	●

Manual Air Hose Reels



This manual heavy-duty drum reel is compact and ideal for indoor shop and industrial applications.



L8650FZ

FEATURES:

- **Heavy-Duty Drum** - Heavy-duty steel reinforced drum
- **Powder Coat Finish** - Provides a smooth and durable finish
- **Inlet Swivel** - Heavy-duty 1/4 in. brass
- **Tapered Side Walls** - Store more hose in less space
- **Swivel Handle** - Pivots in hand for winding ease
- **Mounting Bracket** - Mount reel to wall, workbench, or vehicle
- **Bend Restrictor** - Prolongs the life of the air hose
- **Brake** - Keeps hose from unwinding unintentionally
- **Hose Material** - Flexible Hybrid Polymer
- **Lead-in Hose Included** - 5 ft.

ASSEMBLED IN USA
of US and global components

HOSE I.D.	WORKING PRESSURE	SUPPORT
3/8 IN.	300 PSI	SINGLE

Manual Air Hose Reel – Fixed, Heavy Duty

Part No.	I.D.	Length	Working Pressure @ 70°F	Temperature Range (F°)	Lead-in Hose Connection	Reel Inlet	Hose Outlet	Weight	Retail Packaging	Assembled in USA
L8650FZ	3/8 in.	50 ft.	300 psi	-40° to 140°	1/4 in. MNPT x 1/4 in. MNPT	1/4 in. MNPT	1/4 in. MNPT	16 lbs.	-	

Manual Air Hose Reels – Fixed, Heavy Duty



This manual heavy-duty drum reel is compact and ideal for indoor shop and industrial applications.



FEATURES:

- **Heavy-Duty Drum** - Heavy-duty steel reinforced drum
- **Powder Coat Finish** - Provides a smooth and durable finish
- **Inlet Swivel** - Heavy-duty 1/4 in. brass
- **Tapered Side Walls** - Store more hose in less space
- **Swivel Handle** - Pivots in hand for winding ease
- **Mounting Bracket** - Mount reel to wall, workbench, or vehicle
- **Bend Restrictor** - Prolongs the life of the air hose
- **Dual Support** - Provides extra stability for the big job
- **Spring Tension Brake** - Keeps hose from unwinding unintentionally
- **Hose Material** - Flexible Hybrid Polymer
- **Lead-in Hose Included** - 5 ft.

ASSEMBLED IN USA
of US and global components

L8652FZ

HOSE I.D.	WORKING PRESSURE	SUPPORT
3/8 IN.	300 PSI	DUAL



L8652FZ

Manual Air Hose Reel – Fixed, Heavy Duty

Part No.	I.D.	Length	Working Pressure @ 70°F	Temperature Range (F°)	Lead-in Hose Connection	Reel Inlet	Hose Outlet	Weight	Packaging Type	Assembled in USA
L8652FZ	3/8 in.	100 ft.	300 psi	-40° to 140°	1/4 in. MNPT x 1/4 in. MNPT	1/4 in. MNPT	1/4 in. MNPT	30 lbs.	● ● ●	●
<p>● Retail packaging (English/French)</p> <p>● Individually boxed no retail packaging with suffix -E</p>										

Manual Air Hose Reels – Portable



Designed for portability, these reels are useful just about anywhere on the jobsite. Use an air manifold with the supply hose to service multiple air tools (air manifold is sold separately). The hose layering guide spools hose back onto the reel eliminating tangles; cleanup is faster and easier.



L8651FZ

HOSE I.D.	WORKING PRESSURE
3/8 IN.	300 PSI

FEATURES:

- **Hose Layering Guide** - Manually operated guide smoothly winds hose without tangles
- **Spring Tension Brake** - Keeps hose from unwinding unintentionally
- **Carrying Handle** - For complete portability
- **Support Legs** - Attach support legs for placing reel on ground. Pre-drilled holes can be used for staking reel to the ground



L8654FZ

HOSE I.D.	WORKING PRESSURE
1/4 IN.	300 PSI

- **Mounting Bracket** - Reel can be mounted on truck, wall or bench
- **Swivel Handle** - Swivels in hand for winding ease. Folds in for transporting
- **Hose Material** - Flexible Hybrid Polymer
- **Lead-in Hose Included** - 5 ft.

ASSEMBLED IN USA
of US and global components

Manual Air Hose Reels – Portable

Part No.	I.D.	Length	Working Pressure @ 70°F	Temperature Range (F°)	Lead-in Hose Connection	Reel Inlet	Hose Outlet	Weight	Retail Packaging	Assembled in USA
L8651FZ	3/8 in.	50 ft.	300 psi	-40° to 140°	1/4 in. MNPT x 1/4 in. MNPT	1/4 in. MNPT	1/4 in. MNPT	21 lbs.	●	●
L8654FZ	1/4 in.	100 ft.	300 psi	-40° to 140°	1/4 in. MNPT x 1/4 in. MNPT	1/4 in. MNPT	1/4 in. MNPT	21 lbs.	-	●

● Retail packaging (English/French)

Lead-In Hoses



Flexzilla hose reels come equipped with a lead-in hose as standard equipment. Details regarding the lead-in hose that comes with each reel model are listed below. If for some reason you need to replace your lead-in hose, please refer to the part number that corresponds to your model of reel.

ASSEMBLED IN USA
of US and global components



Part No.	Lead-in Hose For Part Nos.	I.D.	Length	Fittings	Hose Material	Working Pressure @ 70°F	Temperature Range (F°)	Retail Packaging	Assembled in USA
L8011FZLI	L8011FZ	3/8 in.	5 ft.	3/8 in. MNPT Swivel x 3/8 in. MNPT	Flexible Hybrid Polymer	300 psi	-40° to 140°	-	●
L8041FZLI	L8041FZ	1/2 in.	5 ft.	1/2 in. MNPT Swivel x 1/2 in. MNPT	Flexible Hybrid Polymer	300 psi	-40° to 140°	-	-
L8250FZLI	L8250FZ	3/8 in.	3 ft.	1/4 in. MNPT	Flexible Hybrid Polymer	150 psi	-40° to 140°	-	●
L8251FZPLI	L8251FZP	3/8 in.	5 ft.	1/4 in. MNPT	Flexible Hybrid Polymer	150 psi	-40° to 140°	-	●
L8305FZLI	L8305FZ L8306FZ	3/8 in.	5 ft.	3/4 in. Female GHT x 1/4 in. MNPT	Flexible Hybrid Polymer	300 psi	-40° to 140°	-	-
L8335FZLI	L8335FZ	1/2 in.	5 ft.	3/4 in. Female GHT x 3/8 in. MNPT	Flexible Hybrid Polymer	300 psi	-40° to 140°	-	-
L8340FZLI	L8340FZ	1/2 in.	10 ft.	3/4 in. Female GHT x 3/4 in. Female GHT	Flexible Hybrid Polymer	150 psi	-40° to 140°	-	-
L8611FZLI	L8611FZ L8711FZ	3/8 in.	5 ft.	3/8 in. MNPT Swivel x 1/4 in. MNPT	Flexible Hybrid Polymer	300 psi	-40° to 140°	-	●
L8651FZLI	L8550FZ L8560FZ L8603FZ L8650FZ L8651FZ L8652FZ	3/8 in.	5 ft.	1/4 in. MNPT x 1/4 in. MNPT	Flexible Hybrid Polymer	300 psi	-40° to 140°	-	●
L8654FZLI	L8654FZ	1/4 in.	5 ft.	1/4 in. MNPT x 1/4 in. MNPT	Flexible Hybrid Polymer	300 psi	-40° to 140°	-	●

360° ROTATION

Ball swivel rotates
360° at a 30° angle.

HIGH FLOW

High flow couplers and plugs
allow twice the amount of
airflow to your tool.

AIR LINE ACCESSORIES

High Flow Couplers and Plugs



Flexzilla® Pro High Flow couplers and plugs allow Twice The Flow to your air tools compared to standard interchanges. Connect Flexzilla High Flow fittings from your tool all the way to the compressor. This ensures the best performance your air system can provide. For maximum efficiency, use Flexzilla Pro High Flow.



Don't Starve Your Air Tool!

- Push-To-Connect System
- Maximum Torque
- Maximum RPM
- Ideal for spray guns and impact tools or any high output tool

Flexzilla Pro High Flow Ball Swivel brings ergonomic ease to any tool attached to it. Save your wrist and improve your ability to get into hard-to-reach places.

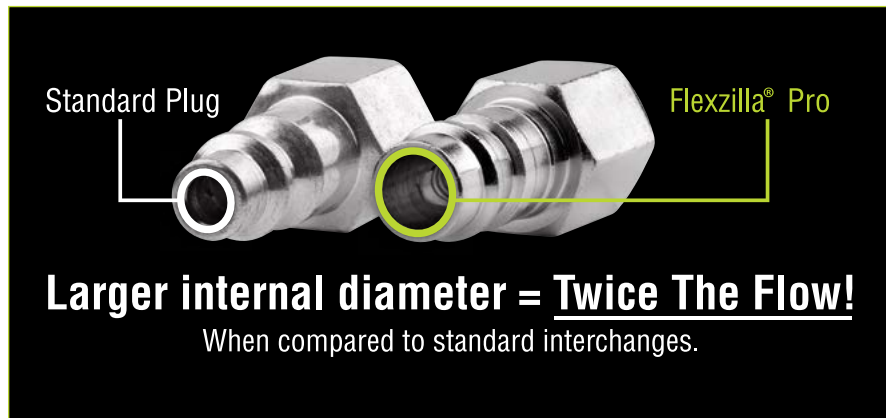

High Flow Couplers and Plugs



PRO

Couplers

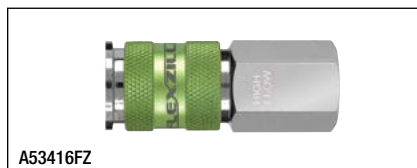

A53416FZ

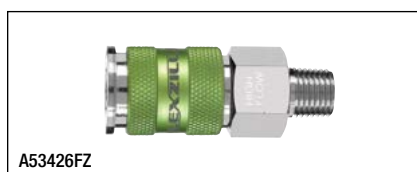

A53426FZ



A53616FZ

Part No.	Type	Interchange	Connection Size	Body Size	Max. Pressure	Material	Retail Packaging
High Flow Couplers							
A53416FZ	Z	High Flow	1/4 in. FNPT	1/4 in.	300 psi	Steel/Aluminum*	●
A53426FZ	Z	High Flow	1/4 in. MNPT	1/4 in.	300 psi	Steel/Aluminum*	●
A53616FZ	Z	High Flow	3/8 in. FNPT	1/4 in.	300 psi	Steel/Aluminum*	●
A53626FZ	Z	High Flow	3/8 in. MNPT	1/4 in.	300 psi	Steel/Aluminum*	●

*Nickel Plated Steel with Anodized Aluminum Sleeve



A53416FZ



A53616FZ

Plugs



PRO

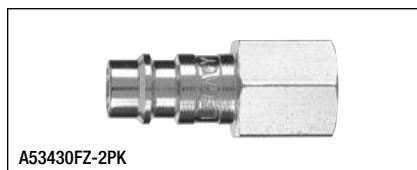

A53430FZ-2PK

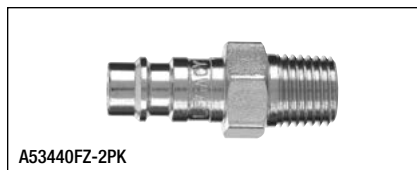

A53440FZ-2PK



A53440FZBS

Part No.	Type	Interchange	Connection Size	Body Size	Max. Pressure	Material	Retail Packaging
High Flow Plugs							
A53440FZBS	Z	High Flow	1/4 in. MNPT	1/4 in.	300 psi	Nickel Plated Steel	●
High Flow Plugs – 2-Pc.							
A53430FZ-2PK	Z	High Flow	1/4 in. FNPT	1/4 in.	300 psi	Nickel Plated Steel	●
A53440FZ-2PK	Z	High Flow	1/4 in. MNPT	1/4 in.	300 psi	Nickel Plated Steel	●
A53630FZ-2PK	Z	High Flow	3/8 in. FNPT	1/4 in.	300 psi	Nickel Plated Steel	●
A53640FZ-2PK	Z	High Flow	3/8 in. MNPT	1/4 in.	300 psi	Nickel Plated Steel	●



A53430FZ-2PK



A53440FZBS

High Flow Coupler and Plug Kits



A53452FZ



A53457FZ



A53657FZ



A53458FZ



A53458FZ Retail Packaging

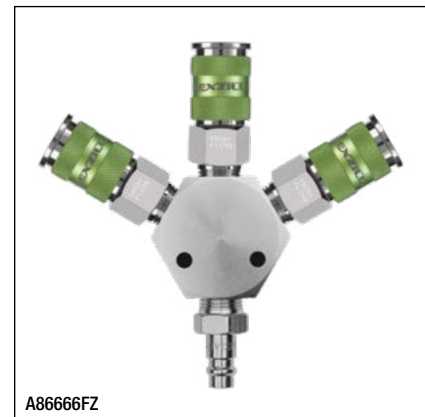

A86666FZ

Part No.	Type	Interchange	Connection Size	Body Size	Max. Pressure	Material	Contents	Retail Packaging
3-Pc. Coupler and Plug Kit								
A53452FZ	Z	High Flow	1/4 in. NPT	1/4 in.	300 psi	Steel/Aluminum*	(1) FNPT Coupler, (1) FNPT Plug and (1) MNPT Plug	●
7-Pc. Coupler and Plug Kits								
A53457FZ	Z	High Flow	1/4 in. NPT	1/4 in.	300 psi	Steel/Aluminum*	(1) FNPT Coupler, (1) MNPT Coupler, (2) FNPT Plug and (3) MNPT Plug	●
A53657FZ	Z	High Flow	3/8 in. NPT	1/4 in.	300 psi	Steel/Aluminum*	(1) FNPT Coupler, (1) MNPT Coupler, (2) FNPT Plug and (3) MNPT Plug	●
14-Pc. Coupler and Plug Kit								
A53458FZ	Z	High Flow	1/4 in. NPT	1/4 in.	300 psi	Steel/Aluminum*	(2) FNPT Coupler, (2) MNPT Coupler, (4) FNPT Plug and (6) MNPT Plug	●
3-Way Manifold								
A86666FZ	Z	High Flow	3/8 in. NPT	1/4 in.	300 psi	Steel/Aluminum*	(1) 3-Way Flat Hex Manifold, (3) A53626FZ and (1) A53640FZ	●

*Nickel Plated Steel with Anodized Aluminum Sleeve

Heavy Duty Safety Couplers and Plugs



PRO

Flexzilla® Pro Heavy Duty Safety Couplers and Plugs feature ZVR™ Technology, Zero Valve Restriction provides maximum CFM possible. Paired with quick, safe and easy connections, Flexzilla Pro HD Couplers and Plugs are the best choice for maximum performance from your air tools.

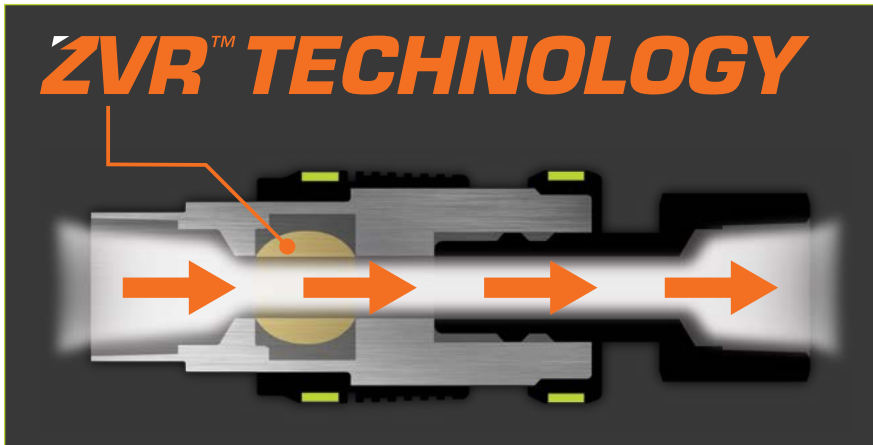

FEATURES:

- ZVR™ Technology - Zero Valve Restriction provides absolute throughput and feeds your tool the maximum CFM possible
- Safety Coupler - Connect and disconnect under zero pressure
- Non-marring

QUICK, SAFE & EASY CONNECTIONS

ENGAGE AT ZERO PRESSURE

DISENGAGE AT ZERO PRESSURE



Push-to-connect under zero pressure



Push sleeve up to open valve and engage air flow



Pull sleeve down to shut off air flow and pull top collar down to disengage plug under zero pressure

Heavy Duty Safety Couplers, Plugs & Kits

PRO



A55618FZ



A55828FZ



A55630FZ



A55840FZ



A55656FZ



A55856FZ

Part No.	Type	Interchange	Connection Size	Body Size	Max. Pressure	Material	Contents	Retail Packaging
Heavy Duty Safety Couplers								
A55618FZ	H	Industrial	3/8 in. FNPT	1/2 in.	175 psi	Multiple*	(1) FNPT Coupler	●
A55628FZ	H	Industrial	3/8 in. MNPT	1/2 in.	175 psi	Multiple*	(1) MNPT Coupler	●
A55818FZ	H	Industrial	1/2 in. FNPT	1/2 in.	175 psi	Multiple*	(1) FNPT Coupler	●
A55828FZ	H	Industrial	1/2 in. MNPT	1/2 in.	175 psi	Multiple*	(1) MNPT Coupler	●
Heavy Duty Safety Plugs								
A55630FZ	H	Industrial	3/8 in. FNPT	1/2 in.	232 psi	Nickel Plated Steel	(1) FNPT Plug	●
A55640FZ	H	Industrial	3/8 in. MNPT	1/2 in.	232 psi	Nickel Plated Steel	(1) MNPT Plug	●
A55830FZ	H	Industrial	1/2 in. FNPT	1/2 in.	232 psi	Nickel Plated Steel	(1) FNPT Plug	●
A55840FZ	H	Industrial	1/2 in. MNPT	1/2 in.	232 psi	Nickel Plated Steel	(1) MNPT Plug	●
5-Pc. Coupler and Plug Kits								
A55656FZ	H	Industrial	3/8 in. NPT	1/2 in.	175 psi	Multiple*	(1) FNPT Coupler, (1) MNPT Coupler, (1) FNPT Plug, and (2) MNPT Plugs	●
A55856FZ	H	Industrial	1/2 in. NPT	1/2 in.	175 psi	Multiple*	(1) FNPT Coupler, (1) MNPT Coupler, (1) FNPT Plug, and (2) MNPT Plugs	●

*Nickel Plated Steel and ABS

MODULAR ACCESSORIES SYSTEM

Includes needle tips, chip guards, extensions and OSHA-compliant safety nozzles.

INCREASED AIR FLOW

Variable flow trigger that can be tailored to a high power job or delicate precision work.

BLOW GUNS

THOUGHTFULLY DESIGNED

Ergonomic handle and rubberized grip.

Modular Blow Guns



Introducing Flexzilla™ Blow Guns and accessories. Flexzilla features an ergonomically superior gun body for maximum comfort and control which reduces operator fatigue. A variable flow trigger regulates air volume precisely with maximum flow, equal to or greater than the competition. The exclusive modular accessories system allows the Flexzilla blow guns to be customized for extension length and tips needed for any job. Flexzilla safety nozzles and bendable extension are labeled to meet or exceed OSHA standards.

BLOW GUN FEATURES:

- Variable flow trigger - regulates air volume precisely with maximum flow, equal to or greater than the competition (X3™ Blow Guns only)
- Brass valve seat and trigger pin - for better sealing and durability (X1™ Blow Guns only)
- Ergonomic handle - for comfort and easy handling
- Storage hook - for easy storage
- 1/4 in. NPT inlet



Part No.	Description	CFM	dBA	Variable Flow Trigger	Meets OSHA Number	Line psi	Retail Packaging
AG1102FZ	Flexzilla™ X3™ Blow Gun with Quiet-Flo Safety Nozzle	36	87	●	1910.95 (a), 1910.242 (b)	100	●
AG1202FZ	Flexzilla™ X3™ Blow Gun with Xtreme-Flo Safety Nozzle	50	99	●	1910.242 (b)	100	●
AG1402FZ	Flexzilla™ X1™ Blow Gun with Quiet-Flo Safety Nozzle	36	87	–	1910.95 (a), 1910.242 (b)	100	●
AG1502FZ	Flexzilla™ X1™ Blow Gun with Xtreme-Flo Safety Nozzle	43	99	–	1910.242 (b)	100	●

Modular Blow Gun Kits

Flexzilla™ X3™ 6-Pc. Blow Gun Kit

AG1200FZKIT INCLUDES:

- a – Flexzilla X3 Blow Gun - with Variable Flow Trigger
- b – 6 in. Extension
- c – Chip Guard
- d – Tri-Thrust Safety Nozzle
- e – Xtreme-Flo Safety Nozzle
- f – Quiet-Flo Safety Nozzle



Flexzilla™ X1™ 10-Pc. Blow Gun Kit

AG1500FZKIT INCLUDES:

- a – Flexzilla X1 Blow Gun
- b – 6 in. Extensions (x2)
- c – Needle Tips (1 in., 2 in. & 3 in.)
- d – Xtreme-Flo Safety Nozzle
- e – Quiet-Flo Safety Nozzle
- f – Rubber Tip
- g – Tip Adapter



Part No.	Retail Packaging
AG1200FZKIT	●
AG1500FZKIT	●

Modular Blow Guns Accessories System

The exclusive modular accessories system (sold separately) allows the Flexzilla™ blow guns to be customized for extension length and tips needed for any job. Flexzilla safety nozzles and bendable extension are labeled to meet or exceed OSHA standards. Extensions can be combined up to 6 feet.

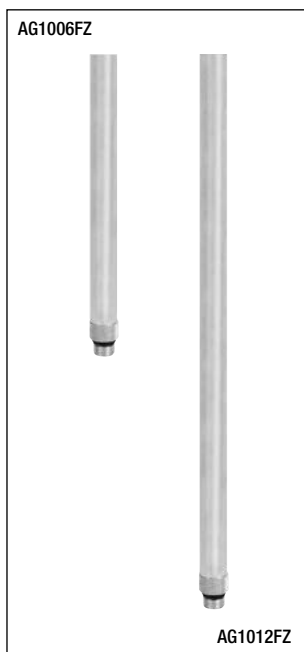
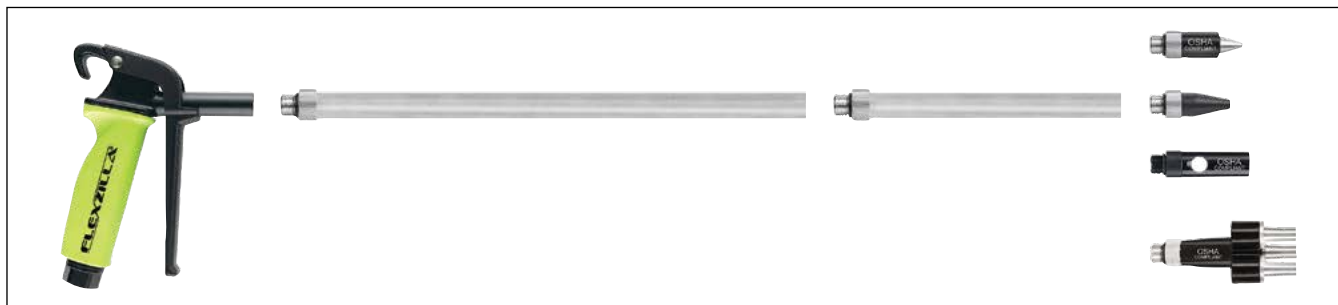

Part No.	Description	Retail Packaging
AG934FZ	Flexzilla™ Rubber Tip	●
AG1090FZ	Flexzilla™ Xtreme-Flo Safety Nozzle	●
AG1091FZ	Flexzilla™ Quiet-Flo Safety Nozzle	●
AG1093FZ	Flexzilla™ Tri-Thrust Safety Nozzle	●
AG1099FZ	Flexzilla™ 5-Pc. Tip Adapter Kit	●
AG1092FZ	Flexzilla™ Chip Guard	●
AG1006FZ	Flexzilla™ 6 in. Extension	●
AG1012FZ	Flexzilla™ 12 in. Extension	●
AG1016FZ	Flexzilla™ 16 in. Bendable Extension	●

TIRE MAINTENANCE



INFLATE AND MONITOR

Inflate and check tire pressure simultaneously at a safe distance.

Tire Inflators



Tire inflators deliver accurate pressure to car, truck, bike, and off-road tires.



AL2000FZ

AL2000FZ FEATURES:

- Range: 20 to 170 psi
- Straight-on chuck with 12 in. air hose
- Heavy-duty gauge
- Indicator bar is calibrated in 2 psi increments from 20 to 100 psi



AL2025FZ-1

AL2025FZ-1 FEATURES:

- Range: 10 to 170 psi
- Quick-connect coupler and plug
- Trigger actuated deflate function
- Straight lock-on connector
- Dial gauge with protective rubber guard
- Includes: 3 ft. air hose extension



L2051FZ

L2051FZ FEATURES:

- Range: 10 to 120 psi
- Controlled inflation and deflation
- Recessed glass sight pressure gauge
- Dual chuck with swivel and lock on threads, 6 in.
- Indicator bar calibrated in 2 psi increments



AL2025FZ-2



AL2025FZ-2 Retail Package

AL2025FZ-2 FEATURES:

- Range: 10 to 170 psi
- Quick-connect coupler and plug
- Trigger actuated deflate function
- Straight lock-on connector
- Dial gauge with protective rubber guard
- Includes: 3 and 15 ft. air hose extensions
- OSHA Compliant - 15 ft. hose only

Part No.	Type	I.D.	Length	Inlet	Body Material	Retail Packaging
AL2000FZ	Tire Inflator	1/4 in.	1 ft.	1/4 in. FNPT	Die-cast Zinc	●
AL2025FZ-1	Inflator	1/4 in.	3 ft.	1/4 in. FNPT	Nylon/Brass	●
AL2025FZ-2	Inflator Kit	1/4 in.	3 ft. & 15 ft.	1/4 in. FNPT	Nylon/Brass	●
AL2051FZ	Inflator Kit	1/4 in.	1 ft.	1/4 in. FNPT	Die-cast Zinc/Brass	●

Truck Tire Inflator Kits



The Flexzilla® truck tire inflator kit uses a truck's on-board air supply to inflate tires in remote situations.



HGH2-FZ

HGH2-FZ INCLUDES:

- 3/8 in. x 50 ft. air hose
- Glad-hand attachment
- 30° Dual air chuck



HGH7-FZ

HGH7-FZ INCLUDES:

- 3/8 in. x 60 ft. air hose
- Glad-hand attachment
- 30° Dual air chuck
- Flexzilla® High Flow coupler and plugs
- Flexzilla® X1™ Blow Gun w/ rubber tip



Part No.	Description	I.D.	Length	Inlet	Retail Packaging
HGH2-FZ	Truck Tire Inflator Kit	3/8 in.	50 ft.	1/4 in. MNPT	●
HGH7-FZ	Truck Tire Inflator Kit, 6 pc.	3/8 in.	60 ft.	1/4 in. MNPT	●

BREAKAWAY TORQUE

Delivers 800 ft-lbs. of nut-busting breakaway torque.

AIR TOOL

LIGHTWEIGHT & COMPACT

Making it easy to get into those hard to reach areas.

Mini Impact Wrench



PRO

Proving once again you don't have to be big to be powerful. Flexzilla® Pro Air Tools pack high RPM and maximum torque into the lightest, most compact air tools on the market. The mini impact wrench has 800 ft-lbs. of nut-busting breakaway torque and an extremely lightweight design.

Flexzilla Pro Mini Impact Wrench (AT1475FZ)

FEATURES:

- 800 ft-lbs. of nut-busting breakaway torque
- Compact design – Ideal for tight spaces, 4.4 in.
- Torque selector – Maximum torque, 550 ft-lbs.
- Extremely lightweight – Composite design, 2.5 lbs.
- Patented Forward/Reverse toggle switch
- Handle exhaust – Directs air away from user
- 1/4 in. NPT air inlet with built-in swivel
- Ergonomic grip
- High speed, 9500 RPM
- Air Consumption: 4.8 CFM
- Drive: 1/2 in.

INCLUDES:

- Flexzilla Pro Mini Impact Wrench
- Flexzilla Pro High Flow 1/4 in. MNPT Ball Swivel Plug

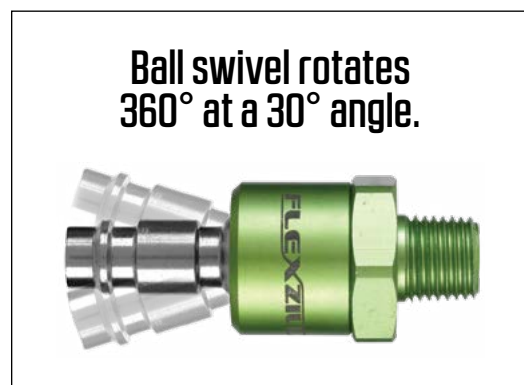

AT1475FZ

Part No.	Retail Packaging
AT1475FZ	●

TORQUE	DRIVE
800 FT-LBS.	1/2 IN.
HIGH SPEED	AIR CONSUMPTION
9500 RPM	4.8 CFM

EXCLUSIVE SWIVELGRIP®

SwivelGrip® allows the hose and grip to rotate independently, releasing coils naturally, easily and effortlessly. The large, comfortable gripping surface on both ends of the hose lets you use the power of your entire hand to make tight connections easy.

(SwivelGrip® Patent Pending)

WATER HOSES

EXTREME ALL-WEATHER FLEXIBILITY

Lightweight and easy to handle, Flexzilla® hoses lay flat and have no memory, even in extreme weather conditions.

FLEXIBLE HYBRID POLYMER™

Flexzilla hoses have a durable, abrasion-resistant outer cover.

SwivelGrip® Garden and Lead-in Hose Assemblies



Premium Flexzilla® SwivelGrip® Garden Hose makes it easier to work around your home and lawn. SwivelGrip action eliminates twists that occur when uncoiling a hose. Conventional garden hose can trap coils that tighten into kinks as you move across the yard. SwivelGrip allows the hose and grip to rotate independently, releasing coils naturally, easily and effortlessly. The large, comfortable gripping surface on both ends of the hose lets you use the power of your entire hand to make tight connections easy. Flexzilla SwivelGrip Garden Hoses are engineered with a lightweight Flexible Hybrid Polymer which lays flat, eliminates kinking under pressure and is drinking water safe..



HFZG550YWS

FEATURES:

- Male and female SwivelGrip® Connections
 - Hose and grip rotate independently
 - Makes connections and uncoiling easy
 - Naturally releases coils
- Extreme all-weather flexibility (max. temp 140°F)
- Durable outer cover resists abrasion, UV and mold
- Won't kink under pressure
- Lightweight and easy to handle
- Lays flat - no memory
- Reinforced mid-layering provides extra strength
- Anodized aircraft aluminum ends
- Max. working pressure at
 - 70°F: 150 psi
 - Drinking water safe

SWIVELGRIP®

HOSE & GRIP ROTATE INDEPENDENTLY

MAKES CONNECTIONS & UNCOILING EASY



TIGHT LEAK-FREE CONNECTIONS

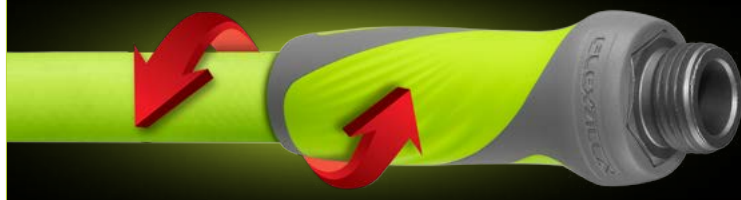

- A large grip lets you use the power of your entire hand to make tight connections easy
- A durable O-ring provides long lasting leak-free connections

SwivelGrip® Garden and Lead-in Hose Assemblies (cont.)



Part No.	I.D.	Length	Fittings	Packaging Type
HFZG503YWS-E	5/8 in.	3 ft.	3/4 in. - 11 1/2 GHT	●
HFZG505YWS	5/8 in.	5 ft.	3/4 in. - 11 1/2 GHT	● ●
HFZG510YWS	5/8 in.	10 ft.	3/4 in. - 11 1/2 GHT	● ● ●
HFZG525YWS	5/8 in.	25 ft.	3/4 in. - 11 1/2 GHT	● ● ● ●
HFZG550YWS	5/8 in.	50 ft.	3/4 in. - 11 1/2 GHT	● ● ● ● ●
HFZG550YWS-30X*	5/8 in.	50 ft.	3/4 in. - 11 1/2 GHT	●
HFZG575YWS	5/8 in.	75 ft.	3/4 in. - 11 1/2 GHT	● ● ● ● ●
HFZG5100YWS	5/8 in.	100 ft.	3/4 in. - 11 1/2 GHT	● ● ● ● ● ●

* HFZG550YWS-30X includes 30 hose assemblies respectively on a quarter pallet display

● Retail packaging (English only)

● Individually boxed no retail packaging with suffix -E

● Retail Packaging with suffix -CA (English/French)



HFZG575YWS



HFZG505YWS



HFZG505YWS



HFZG575YWS

Garden Hose Merchandiser and Pallets





Garden Hose Shelf Tray



Garden Hose Quarter Pallet
HFZG550YWS-30X



Garden Hose Pallet
HFZG550YW-48T

Garden and Lead-in Hose Assemblies



Flexzilla® Garden Hose is engineered with a Flexible Hybrid Polymer that is both lightweight and durable. This premium hose redefines flexibility and is easy to maneuver around your yard. Flexzilla Garden Hose has zero memory which allows the hose to lay flat and ensures that sprinklers stay put without twisting. Its durable outer cover is abrasion-resistant, and the reinforced mid-layering provides extra strength. Plus, with our superior O-ring, you get a long-term, leak-free connection at the spigot. The Flexible Hybrid Polymer inner tube material is drinking water safe.



HFZG550YW



HFZG503YW



HFZG510YW



HFZG550YW

Part No.	I.D.	Length	Fittings	Packaging Type		
HFZG505YW	5/8 in.	5 ft.	3/4 in. - 1 1/2 GHT	●	●	
HFZG505YWL1	5/8 in.	5 ft.	3/4 in. - 1 1/2 GHT	●		
HFZG510YW	5/8 in.	10 ft.	3/4 in. - 1 1/2 GHT	●	●	●
HFZG510YWL1	5/8 in.	10 ft.	3/4 in. - 1 1/2 GHT	●		
HFZG525YW	5/8 in.	25 ft.	3/4 in. - 1 1/2 GHT	●	●	
HFZG550YW	5/8 in.	50 ft.	3/4 in. - 1 1/2 GHT	●	●	●
HFZG550YW-48T	5/8 in.	50 ft.	3/4 in. - 1 1/2 GHT	●		
HFZG575YW	5/8 in.	75 ft.	3/4 in. - 1 1/2 GHT	●	●	
HFZG575YW-48T	5/8 in.	75 ft.	3/4 in. - 1 1/2 GHT	●		
HFZG5100YW	5/8 in.	100 ft.	3/4 in. - 1 1/2 GHT	●	●	●
HFZG5100YW-36T	5/8 in.	100 ft.	3/4 in. - 1 1/2 GHT	●		
HFZG650YW*	3/4 in.	50 ft.	3/4 in. - 1 1/2 GHT	●	●	
HFZG675YW*	3/4 in.	75 ft.	3/4 in. - 1 1/2 GHT	●	●	●
HFZG6100YW*	3/4 in.	100 ft.	3/4 in. - 1 1/2 GHT	●	●	
Part nos. with a -36T or -48T suffix include 36 or 48 hose assemblies respectively on a pallet display						
● Retail packaging (English only)						
● Individually boxed no retail packaging with suffix -E						
● Retail Packaging with suffix -CA (English/French)						

Colors™ SwivelGrip® Garden Hose Assemblies



From the makers of Flexzilla®, Colors™ Garden Hose makes it easier to work around your home and lawn. SwivelGrip action eliminates twists that occur when uncoiling a hose. Conventional garden hose can trap coils that tighten into kinks as you move across the yard. SwivelGrip allows the hose and grip to rotate independently, releasing coils naturally, easily and effortlessly. The large, comfortable gripping surface on both ends of the hose lets you use the power of your entire hand to make tight connections easy. Premium Colors™ Garden Hose features the same Flexible Hybrid Polymer material as our renowned ZillaGreen® hoses, but comes in earthy colors ideal for a variety of landscapes.



HFZC550BRS

FEATURES:

- Male and female SwivelGrip® Connections
 - Hose and grip rotate independently
 - Makes connections and uncoiling easy
 - Naturally releases coils
- Extreme all-weather flexibility (max. temp 140°F)
- Durable outer cover resists abrasion, UV and mold
- Won't kink under pressure
- Lightweight and easy to handle
- Lays flat - no memory
- Reinforced mid-layering provides extra strength
- Anodized aircraft aluminum ends
- Max. working pressure at 70°F: 150 psi
- Drinking water safe

SWIVELGRIP®

HOSE & GRIP ROTATE INDEPENDENTLY

MAKES CONNECTIONS & UNCOILING EASY



**TIGHT
LEAK-FREE
CONNECTIONS**



- A large grip lets you use the power of your entire hand to make tight connections easy
- A durable O-ring provides long lasting leak-free connections

Colors™ SwivelGrip® Garden Hose Assemblies (continued)



HFZC550BRS



HFZC550BRS



HFZC550TCS

Part No.	Color	I.D.	Length	Fittings	Packaging Type
HFZC505BRS-E	Brown Mulch	5/8 in.	5 ft.	3/4 in. - 1 1/2 GHT	●
HFZC505GRS-E	Forest Green	5/8 in.	5 ft.	3/4 in. - 1 1/2 GHT	●
HFZC505GYS-E	Slate Gray	5/8 in.	5 ft.	3/4 in. - 1 1/2 GHT	●
HFZC505TCS-E	Red Clay	5/8 in.	5 ft.	3/4 in. - 1 1/2 GHT	●
HFZC510BRS-E	Brown Mulch	5/8 in.	10 ft.	3/4 in. - 1 1/2 GHT	●
HFZC510GRS-E	Forest Green	5/8 in.	10 ft.	3/4 in. - 1 1/2 GHT	●
HFZC510GYS-E	Slate Gray	5/8 in.	10 ft.	3/4 in. - 1 1/2 GHT	●
HFZC510TCS-E	Red Clay	5/8 in.	10 ft.	3/4 in. - 1 1/2 GHT	●
HFZC525BRS-E	Brown Mulch	5/8 in.	25 ft.	3/4 in. - 1 1/2 GHT	●
HFZC525GRS-E	Forest Green	5/8 in.	25 ft.	3/4 in. - 1 1/2 GHT	●
HFZC525GYS-E	Slate Gray	5/8 in.	25 ft.	3/4 in. - 1 1/2 GHT	●
HFZC525TCS-E	Red Clay	5/8 in.	25 ft.	3/4 in. - 1 1/2 GHT	●
HFZC550BRS	Brown Mulch	5/8 in.	50 ft.	3/4 in. - 1 1/2 GHT	● ●
HFZC550GRS	Forest Green	5/8 in.	50 ft.	3/4 in. - 1 1/2 GHT	● ●
HFZC550GYS	Slate Gray	5/8 in.	50 ft.	3/4 in. - 1 1/2 GHT	● ●
HFZC550TCS	Red Clay	5/8 in.	50 ft.	3/4 in. - 1 1/2 GHT	● ●
HFZC575BRS-E	Brown Mulch	5/8 in.	75 ft.	3/4 in. - 1 1/2 GHT	●
HFZC575GRS-E	Forest Green	5/8 in.	75 ft.	3/4 in. - 1 1/2 GHT	●
HFZC575GYS-E	Slate Gray	5/8 in.	75 ft.	3/4 in. - 1 1/2 GHT	●
HFZC575TCS-E	Red Clay	5/8 in.	75 ft.	3/4 in. - 1 1/2 GHT	●
HFZC5100BRS-E	Brown Mulch	5/8 in.	100 ft.	3/4 in. - 1 1/2 GHT	●
HFZC5100GRS-E	Forest Green	5/8 in.	100 ft.	3/4 in. - 1 1/2 GHT	●
HFZC5100GYS-E	Slate Gray	5/8 in.	100 ft.	3/4 in. - 1 1/2 GHT	●
HFZC5100TCS-E	Red Clay	5/8 in.	100 ft.	3/4 in. - 1 1/2 GHT	●

● Retail packaging (English only)

● Individually boxed no retail packaging with suffix -E



HFZC550GRS



HFZC550GYS



HFZC550GYS

Garden Hose Kit with Quick Connect Attachments, 5-Piece



The Flexzilla® Garden Hose Kit with Quick Connect Attachments features Flexible Hybrid Polymer material with extreme all-weather flexibility that allows hose to lie flat and won't kink under pressure. It's lightweight and coils easily. The convenient Flexzilla Garden Hose Kit comes with hose, twist action nozzle, quick connect flow-stop coupler, spigot adapter, hose adapters and hose hanger to make gardening a snap.

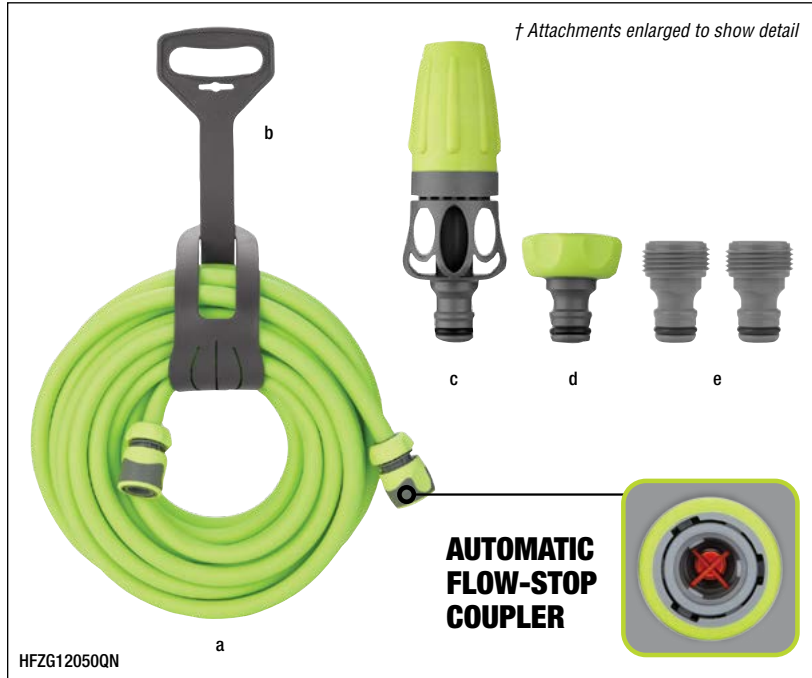

Part No.	Hose I.D.	Hose Length	Fittings	Retail Packaging
HFZG12050QN	1/2 in.	50 ft.	3/4 in. - 1 1/2 GHT	●

HOSE FEATURES:

- Extreme all-weather flexibility (max. temp 140°F)
- Won't kink under pressure
- Lightweight, coils easily
- Lays flat - no memory
- Durable outer cover resists abrasion, UV and mold
- Reinforced mid-layering provides extra strength
- Quick connect couplers
- Max. working pressure at 70°F: 150 psi
- Drinking water safe

SPRAY NOZZLE FEATURES:

- Soft mist for flowers and plants
- Jet spray for long distances (up to 20 ft.)

GARDEN HOSE KIT INCLUDES:

- a – Flexzilla Garden Hose with Quick Connect Couplers
- b – Hose Hanger
- c – Quick Connect Spray Nozzle
- d – Quick Connect Spigot Adapter
- e – (2) Quick Connect Attachment Adapters



3-Piece Nozzle Kit with Quick Connections



KIT INCLUDES:

- Quick Connect Spray Nozzle
 - Soft mist for flowers and plants
 - Jet spray for long distances (up to 20 ft.)
- Flow-Stop Coupler – Prevents user from being sprayed when connecting and disconnecting
- Quick Connect Attachment Adapter – Easily connect to sprinkler or other attachments

Part No.	Packaging Type
HFZGAK01	
HFZGAK02	● ●
	● Retail packaging (English only)
	● Retail Packaging with suffix -CA (English/French)



Quick Connect Garden Hose Fittings



Flexzilla™ Quick-Connect Garden Hose Fittings make connecting and disconnecting attachments fast and easy. Switch out nozzles and sprinklers in a snap by attaching an adapter to all of your favorite watering tools. Connect Flow-Stop Couplers for effortless connections to adapters and spigots. Plus, our Flow-Stop Couplers automatically stop water flow, preventing spray back when connecting and disconnecting the hose. Add convenient, water-tight connections from the spigot to sprayer with Flexzilla Quick-Connect Garden Hose Fittings.

COMMON FEATURES:

- Flow-Stop Coupler prevents user from being sprayed when connecting and disconnecting
- Easily connect to standard garden hose threads (3/4 in. - 1 1/2 GHT)
- Compatible with Flexzilla® Quick-Connect Flow-Stop Couplers and Water Hose Adapters

Part No.	Description	Retail Packaging
HFZGAK11	2-Piece Coupler & Plug Kit	●
HFZGAK12	3-Piece Coupler & Plug Kit	●
HFZGAK13	5-Piece Plug Kit	●
HFZGAK14	5-Piece Coupler & Plug Kit	●



HFZGAK11 KIT INCLUDES:

- (1) Quick-Connect Coupler, Male
- (1) Quick-Connect Water Hose Adapter, Female Plug



HFZGAK12 KIT INCLUDES:

- (1) Quick-Connect Flow-Stop Coupler, Female
- (2) Quick-Connect Water Hose Adapters, Male Plugs



HFZGAK13 KIT INCLUDES:

- (1) Quick-Connect Water Hose Adapter, Female Plug
- (4) Quick-Connect Water Hose Adapters, Male Plugs



HFZGAK14 KIT INCLUDES:

- (1) Quick-Connect Flow-Stop Coupler, Female
- (1) Quick-Connect Coupler, Male
- (1) Quick-Connect Water Hose Adapter, Female Plug
- (2) Quick-Connect Water Hose Adapters, Male Plugs

Marine Twin Outboard Flush Kit, 6-Piece

Never leave your boat after turning on the water! This convenient and time saving Flexzilla® Marine Flush Kit allows you to flush twin outboard motors without the hassle of getting on and off the boat before turning on the water. The 6-piece kit features SwivelGrip® water hose engineered with flexible hybrid polymer material, a large grip, leak-free connections, dual on/off y-splitter, and quick-connect adapters. The automatic quick-connect flow-stop coupler prevents the user from being sprayed when connecting and disconnecting. Plus, the quick-connect nozzle allows you use the main hose to wash down your boat. The kit is lightweight, compact and easy to store on board any boat.

FEATURES:

- SwivelGrip® Water Hose - Ends make connections fast and easy. A large grip lets you use the power of your entire hand to make tight connection to your outboard motor easy
- Y-Splitter with Dual On/Off Valves - The splitter allows you to feed water into twin outboard motors at the same time or it can be used to flush one motor at a time
- Quick-Connect Flow-Stop Coupler - Turn on water at the spigot and connect flush kit to main hose. Coupler prevents user from being sprayed when connecting and disconnecting
- Quick-Connect Adapters - Make it easy to connect the flush kit
- Quick-Connect Nozzle - The soft mist to jet spray pattern makes it easy to wash down the boat
- Convenient and Time Saving Kit - No more hassle of getting on and off the boat before turning on the water
- For use on board or while the boat is on the trailer

KIT INCLUDES:

- (2) 3 ft. Flexzilla SwivelGrip Water Hoses
- (1) Dual On/Off Y-Splitter
- (1) Quick-Connect Flow-Stop Coupler - Female
- (1) Quick-Connect Water Hose Plug - Male
- (1) Quick-Connect Spray Nozzle



HFZGSK01

CONVENIENT AND TIME SAVING...

Never leave your boat after turning on the water!

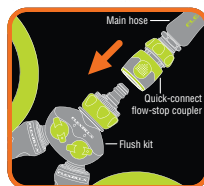

QUICK-CONNECT COUPLER WITH AUTO FLOW-STOP

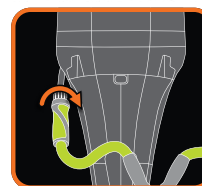

SWIVELGRIP® ENDS MAKE CONNECTIONS FAST AND EASY



DUAL ON/OFF VALVES

Part No.	Retail Packaging
HFZGSK01	●

2-Way Hose Splitter



HFZGAG0

The Flexzilla™ 2-Way Hose Splitter eliminates the frustration of switching out hoses by creating two water sources from a single spigot.

FEATURES:

- Twist action on/off valves - Controls water flow for two hoses
- Soft grip swivel nut for easy connections
- Spigot adapter: 1 in. to 3/4 in. GHT reducer bushing
- For outdoor and shop use: 40° to 120°F
- Leak-free O-ring
- Works with standard water hose or sprinklers

Part No.	Fitting Size	Retail Packaging
HFZGAG0	1 in. or 3/4 in. GHT	●

Garden Hose Nozzles

Flexzilla™ Garden Hose Nozzles are designed for a wide range of watering needs and are suitable for gardening, cleaning, washing your car, or showering dogs and pets. They are available in a variety of styles, are simple to operate and built to withstand of tough use.

COMMON FEATURE:

- Leak-free connections - O-ring seal provides secure, watertight connections to garden hoses



NFZG51 FEATURES:

- Thumb actuated pressure control - adjusts from maximum spray to gentle flow
- Heavy duty and durable metal construction
- Variable flow pattern - Soft mist to jet spray
- Soft grip dial guard
- Comfortable non-slip rubber grip



NFZG52 FEATURES:

- Thumb actuated pressure control - adjusts from maximum spray to gentle flow
- Heavy duty and durable metal construction
- 7 adjustable spray patterns: jet, rinse, center, shower, cone, mist, flat
- Soft grip dial guard
- Comfortable non-slip rubber grip



NFZG61 FEATURES:

- Thumb actuated design - 3 position
- Heavy duty metal construction
- Adjustable spray patterns: shower, flat, jet
- Soft grip dial guard
- Ergonomic soft grip handle



NFZG21 FEATURES:

- Soft mist for flowers and plants
- Jet spray for long distances (up to 20 ft.)
- Soft grip outer housing
- Compact design



NFZG62 FEATURES:

- Variable flow pattern - Soft mist to jet spray
- Heavy duty metal construction
- Soft grip outer housing
- Compact design



NFZG63 FEATURES:

- Adjustable spray patterns: shower, full, jet, cone
- Soft grip dial guard

Part No.	Description	Packaging Type
NFZG21	Twist Action Garden Hose Nozzle - 4-Pattern	●
NFZG51	Heavy Duty Twist Action Adjustable Flow Garden Hose Nozzle	● ●
NFZG52	Heavy Duty 7-Pattern Adjustable Flow Garden Hose Nozzle	● ●
NFZG61	Heavy Duty Pistol Grip Garden Hose Nozzle	● ●
NFZG62	Heavy Duty Twist Action Garden Hose Nozzle	● ● ●
NFZG63	Twist Action Garden Hose Nozzle - 4-Pattern	●
● Retail packaging (English only)		
● Individually boxed no retail packaging with suffix -E		
● Retail Packaging with suffix -CA (English/French)		

Garden Hose Nozzles (continued)



NFZG64 FEATURES:

- On/Off toggle switch with variable flow
- 6 adjustable spray patterns: mist, vertical, shower, cone, flat, jet
- Durable outer housing
- Soft grip dial guard
- Lightweight soft grip handle



NFZG65 FEATURES:

- Rotate nozzle to adjust water flow from a fine mist to a powerful jet stream
- Twist action knob that allows adjustable water flow
- On/off trigger with locking mechanism
- Comfortable non-slip rubber grip
- Compact and lightweight design
- Durable outer housing



NFZG66 FEATURES:

- 7 adjustable spray patterns: mist, flat, cone, center, shower, jet, spout
- On/off trigger with locking mechanism
- Comfortable non-slip rubber grip
- Compact and lightweight design
- Durable outer housing



NFZG67 FEATURES:

- Heavy duty and durable metal construction
- 7 adjustable spray patterns: mist, vertical, shower, center, cone, flat, jet
- Flow control dial allows greater watering control
- On/off trigger with locking mechanism
- Soft grip dial guard
- Twice rubberized grip for extra comfort



NFZG69 FEATURES:

- Adjustable pressure control - adjusts from maximum spray to gentle flow
- Heavy duty metal construction
- 7 adjustable spray patterns: mist, vertical, shower, center, cone, flat, jet
- Soft grip dial guard
- Ergonomic soft grip handle

Part No.	Description	Packaging Type
NFZG64	Adjustable Garden Hose Nozzle - 6-Pattern	● ●
NFZG65	Metal Adjustable Pistol Grip Garden Hose Nozzle	● ●
NFZG66	Metal 7-Pattern Adjustable Pistol Grip Garden Hose Nozzle	● ●
NFZG67	Heavy Duty 7-Pattern Adjustable Pistol Grip Garden Hose Nozzle	● ●
NFZG69	Heavy Duty 7-Pattern Adjustable Flow Pistol Grip Garden Hose Nozzle	● ●
		● Retail packaging (English only)
		● Individually boxed no retail packaging with suffix -E

Garden Hose Nozzles (continued)



NFZG70 FEATURES:

- Angle adjustable head with 180° rotation
- 28 in. wand to water hanging planters, new plantings and delicate flowers
- On/Off toggle switch with variable flow control and prevention of user fatigue
- 3 adjustable spray patterns: jet, mist, shower

- Soft grip dial guard
- Durable outer housing
- Lightweight soft grip handle

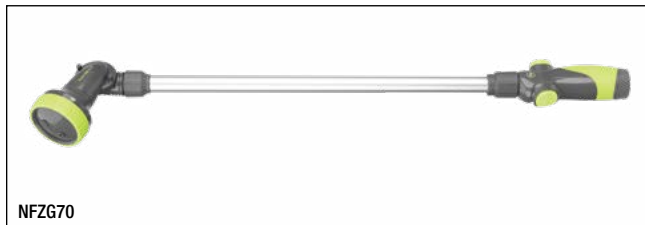

NFZG70

Part No.	Description	Packaging Type
NFZG70	Adjustable Watering Wand, 28 in. - 3-Pattern	● ●
	● Retail packaging (English only)	
	● Individually boxed no retail packaging with suffix -E	

Lawn Sprinklers



**WATER AREA UP TO
2,400 SQ. FT.**

Flexzilla™ Oscillating Lawn Sprinklers are essential tools for watering your lawn or garden. Waters a range up to 2,400 sq. ft. using 18 durable plastic nozzles. The range adjustment collar allows you to set the precise coverage area to efficiently water your yard. Our proven design makes this sprinkler ideal for everyday watering needs.



SFZG61

SFZG62

COMMON FEATURES:

- Range adjustment collar makes it easy to position water where you need it without wasting water on the sidewalk or driveway
- 18 plastic jet nozzles cover up to 2,400 sq. ft. in your lawn or garden
- Clog resistant filter allows water to flow evenly
- Nozzle cleaning tool and end plug
- Leak-free connections - Rubber gasket provides secure, watertight connections to garden hoses

SFZG62 FEATURES:

- Metal Base - Ensures the sprinkler stays in place and does not flip over during use.

Part No.	Description	Packaging Type
SFZG61	Oscillating Lawn Sprinkler, 2,400 sq. ft.	● ●
SFZG62	Oscillating Lawn Sprinkler with Metal Base, 2,400 sq. ft.	● ●
	● Retail packaging (English only)	
	● Individually boxed no retail packaging with suffix -E	



NFZG01-N

NFZG02-N

Part No.	Retail Packaging
NFZG01-N	●
NFZG02-N	●
	● Retail packaging (English/French)

Water Nozzles



FEATURES:

- Precision flow port – Inline connection allows water to flow directly, not up and through the handle – increases water flow, pressure and power by approximately 30%
- Multiple spray patterns – Select from jet, fan, power or low flow spray – perfect for any job in the shop, garage or home
- Ergonomic handle provides an easy grip for less user fatigue
- Machined aircraft aluminum barrel and Santoprene™ rubber handle and head
- Durable, non-marring outer cover that protects painted surfaces
- Leak-free O-ring - outlasts the competition
- Works with 1/2, 5/8 and 3/4 in. water hose

Water Hose Assemblies - Field Repairable



Flexzilla® Pro Water Hose was designed for professional use. It offers all the unique, efficient qualities of other Flexzilla hoses – it's lightweight, it lies flat, it's flexible in any weather, durable and abrasion-resistant and it will not kink when under water pressure. Also, it's easily repaired on the jobsite in a few simple steps. Plus, with our superior O-ring, you get a long-term, leak-free connection at the spigot. The Flexible Hybrid Polymer inner tube material is drinking water safe.

FEATURES:

- **Field Repairable** – Reusable anodized aircraft aluminum fittings
- Extreme all-weather flexibility (max. temp 140°F)
- Lightweight, coils easily
- Won't kink under pressure
- Lays flat - no memory
- Durable outer cover resists abrasion, UV and mold
- Reinforced mid-layering provides extra strength
- Leak free connections - A durable O-ring provides long lasting leak free connections
- Max. working pressure at 70°F: 150 psi
- Flexzilla Pro Reusable Fittings include bend reinforcement for increased flexibility. Reduces wear and tear, prolonging the life of the hose.
- Drinking water safe



HFZWP550



HFZWP550

Part No.	Hose I.D.	Hose Length	Fittings	Retail Packaging
HFZWP550	5/8 in.	50 ft.	3/4 in. - 11½ GHT	●
HFZWP5100	5/8 in.	100 ft.	3/4 in. - 11½ GHT	●

3 EASY STEPS

FIELD REPAIRABLE



1 CUT – Measure and cut desired length of hose at 90° angle.



2 INSTALL – Slide spiral fitting and nut onto hose. Push hose onto fitting until hose reaches threads.



3 TIGHTEN – Tighten fitting nut until snug. Slide bend restrictor up and snap onto nut.

Retractable Water Hose Reel with Levelwind™ Technology



Featuring Levelwind™ – Flexzilla’s unique winding system that automatically layers hose back and forth across the reel ensuring that the hose is coiled smoothly, easily...every time – and includes Flexzilla® water hose and lead-in hose.



L8340FZ

L8340FZ - Flexzilla® Levelwind™ Retractable Water Hose Reel, 1/2" x 70'



FEATURES:

- **Latching Mode Switch** – Choose from latching hose every 3 ft. for extended use or switch to free run for immediate automatic rewinding
- **Seven Position Locking Bracket** – These reels can swivel freely on the mounting bracket up to 135° or can be locked into place using the locking brace. Up to seven different locking angles can be utilized (L8300-W)
- **Adjustable Hose Stopper** – Increase or decrease the length of the hose that remains when hose is fully retracted
- **Extra Large Swivel** – A 3/4 in. swivel reduces flow restriction and allows maximum flow
- **Freestanding Base** – Portable - Use freestanding or mounted on wall or ceiling. Flat base allows reel to rest on ground
- **Built-In Handle** – For carrying ease
- **Durable Construction** – Made from durable UV stabilized polypropylene
- **Lead-in Hose Included** – 10 ft. x 3/4 in. x 1 1/2 GHT (L8340FZLI)

ASSEMBLED IN USA
of US and global components

Part No.	Hose I.D.	Hose Length	Hose Material	Working Pressure @ 70°F	Reel Inlet	Weight	Retail Packaging	Assembled in USA
L8340FZ	1/2 in.	70 ft.	Flexible Hybrid Polymer	150 psi	3/4 in. – 1 1/2 Male GHT	31 lbs.	●	●



Pressure Washer Hose Assemblies



Flexzilla® offers a revolutionary pressure washer hose that redefines flexibility. Unlike other pressure washer hose, Flexzilla stays flexible when pressurized during use and offers minimal memory when depressurized. It also lays flat and won't work against you before, during or after use.



HFZPW3425M



HFZPW3550M



HFZPW3425M



HFZPW36450M



HFZPW42650Q



HFZPW3550M-3X

Part No.	I.D.	Length	Fittings	Yoke/ Stem	Max. Working Pressure @ 70°F	Packaging Type	Made in USA
HFZPW3425M	1/4 in.	25 ft.	M22	14mm	3,100 psi	● ● ●	●
HFZPW3425M-4X	1/4 in.	25 ft.	M22	14mm	3,100 psi	● ● ●	●
HFZPW3450M	1/4 in.	50 ft.	M22	14mm	3,100 psi	● ● ●	●
HFZPW3450M-3X	1/4 in.	50 ft.	M22	14mm	3,100 psi	● ● ●	●
HFZPW3525M	5/16 in.	25 ft.	M22	14mm	3,100 psi	● ● ●	●
HFZPW3525M-4X	5/16 in.	25 ft.	M22	14mm	3,100 psi	● ● ●	●
HFZPW3550M	5/16 in.	50 ft.	M22	14mm	3,100 psi	● ● ●	●
HFZPW3550M-3X	5/16 in.	50 ft.	M22	14mm	3,100 psi	● ● ●	●
HFZPW36425M	1/4 in.	25 ft.	M22	14mm	3,600 psi	● ● ●	●
HFZPW36450M	1/4 in.	50 ft.	M22	14mm	3,600 psi	● ● ●	●
HFZPW40525M	5/16 in.	25 ft.	M22	14mm	4,000 psi	● ● ●	●
HFZPW40550M	5/16 in.	50 ft.	M22	14mm	4,000 psi	● ● ●	●
HFZPW426050Q	3/8 in.	50 ft.	Integrated Quick Connect	—	4,600 psi	● ● ●	●
HFZPW426100Q	3/8 in.	100 ft.	Integrated Quick Connect	—	4,600 psi	● ● ●	●

Part nos. with -3X or -4X suffix include 3 or 4 hose assemblies respectively in a retail merchandiser display

● Retail packaging (English only)

● Individually boxed no retail packaging with suffix -E

FEATURES:

- Extreme flexibility under pressure, from subzero to 140°F
- Made of Flexible Hybrid Polymer material
- Integral non-kink bend restrictor
- Cold water use only
- Available with M22 or Integrated Quick Connect fittings

MADE IN USA
of US and imported parts

LIGHTED PLUG

Light up any work site with the lighted power indicator, ensuring you can always find the power source.

GLOW STRIPE

Features a glow-in-the-dark stripe that runs the length of the cord.

EXTENSION CORDS

Extension Cords



PRO

Flexzilla® Pro industrial grade extension cords are engineered to hold up to the toughest jobs. They are easy to coil and remain flexible in temperatures as low as -58°F and up to 140°F. Plus, the grounded plug includes a lighted power indicator which lets you know power is running through the cord. Flexzilla Pro Extension Cords are ideal for outdoor industrial grade applications.

FEATURES:

- Extreme all-weather flexibility (-58°F to 140°F)
- Abrasion and corrosion-resistant
- Glow-in-the-dark stripe
- Power indicator light
- Resists kinks and easy to coil
- Grounded plug
- Water Resistant
- Flame Retardant
- Outdoor use
- cULus Listed



FZ512725



FZ512830



FZ512935

Part No.	Cord Length	Gauge	Retail Packaging
FZ512930	50 ft.	10 ga.	●
FZ512935	100 ft.	10 ga.	●
FZ512825	25 ft.	12 ga.	●
FZ512830	50 ft.	12 ga.	●
FZ512835	100 ft.	12 ga.	●
FZ512725	25 ft.	14 ga.	●
FZ512730	50 ft.	14 ga.	●
FZ512735	100 ft.	14 ga.	●

● Retail packaging (English/Spanish)



FZ512835



Flexzilla® Pro Extension Cords are manufactured by Prime Wire & Cable, Inc. in partnership with Legacy Manufacturing Company, and are distributed by both Prime Wire & Cable and Legacy Mfg. Co.

Retractable Extension Cord Reels



Flexzilla® Retractable Extension Cord Reels come pre-loaded with 25 or 50 feet of oil-resistant cord, a lighted triple tap outlet and grounded 5 foot lead-in cord. Each reel also contains a circuit breaker with reset button, adjustable cord stopper, power indicator light, and a swivel mounting bracket. The reels lock the cord out in 1 foot increments. The impact resistant housing protects and stores the extension cord when not in use. These retractable reels are ideal for general, commercial and industrial use.



FZ8160253

GAUGE	CORD LENGTH
16/3 AWG	25 FT.



FZ8140503

GAUGE	CORD LENGTH
14/3 AWG	50 FT.

FEATURES:

- Lighted triple tap outlet for plenty of capacity
- Circuit breaker with reset button prevents breaker from tripping and blown fuses
- Reset circuit at reel
- Oil-Resistant AWG SJTOW cord flexible in low temperatures and resists the effects of oil, water and sunlight
- Swivel mounting bracket pivots in the direction of your work
- Reel can be mounted to wall or ceiling

- Cord locks out in 1 ft. increments
- Adjustable cord stopper ensures outlet is always within reach
- Power indicator light
- Grounded plug includes 5 ft. lead-in cord
- Impact resistant housing
- Recommended for dry, indoor locations
- cULus Listed



Part No.	Cord Length	Cord Gauge	Max. Watts	Max. Amps	Max. Voltage	Max. Hz	Retail Packaging
FZ8160253	25 ft.	16/3 AWG	1250W	10A	125V	60 Hz	●
FZ8140503	50 ft.	14/3 AWG	1625W	13A	125V	60 Hz	●

● Retail packaging (English/French)

Retractable Extension Cord Reel

PRO

The Flexzilla® Pro Retractable Extension Cord Reel comes pre-loaded with 60 feet of cord, a lighted triple tap outlet and grounded 4.5 foot lead-in cord. The 12 gauge oil resistant cord allows you to power heavy-duty equipment in the shop or on the jobsite. The reel utilizes a self-leveling system, which winds the cord evenly as it automatically retracts. The reel also contains a circuit breaker with reset button, adjustable cord stopper, power indicator light, and a swivel mounting bracket. The reel locks the cord out in 2 foot increments. The impact resistant housing protects and stores the extension cord when not in use. This retractable reel is ideal for commercial and industrial use.

FEATURES:

- Self-Leveling System winds the cord evenly
- Lighted triple tap outlet for plenty of capacity
- Circuit breaker with reset button prevents breaker from tripping and blown fuses. Reset circuit at reel
- Power indicator light
- Oil resistant 12/3 AWG SJTOW cord flexible in low temperatures and resists the effects of oil, water and sunlight
- Cord locks out in 2 ft. increments
- Adjustable cord stopper ensures outlet is always within reach
- Grounded plug includes 4.5 ft. lead-in cord
- Swivel mounting bracket pivots in the direction of your work. Reel can be mounted to wall or ceiling
- Impact resistant housing
- Recommended for dry, indoor locations



FZ8120603



Grounded Plug



GAUGE
12/3 AWG

CORD LENGTH
60 FT.



FZ8120603



SELF-LEVELING SYTEM

Part No.	Cord Length	Cord Gauge	Max. Watts	Max. Amps	Max. Voltage	Max. Hz	Retail Packaging
FZ8120603	60 ft.	12/3 AWG	1875W	15A	125V	60 Hz	●

● Retail packaging (English/French)

GREASING EQUIPMENT

FLEXZILLA® GREASE HOSE

Stays flexible, even in subzero temperatures.



LED LIGHTING

Keep your work space well-lit long after sundown.

RAPID RELOAD™ TECHNOLOGY

Push button technology that allows for quick cartridge loading and includes a threadless grease barrel.
(Rapid Reload™ Push Button Technology Patent Pending)



20V Cordless Grease Gun Kit



There is a new creature dominating automotive shops, farms and worksites across the country. Introducing the Flexzilla® 20V Cordless Grease Gun Kit. It proves what can be accomplished when you combine over 30 years of grease gun experience from Legacy Manufacturing with the extreme performance of Flexzilla.

L1388LFZ KIT INCLUDES:

- Flexzilla 20V Cordless Grease Gun
- Flexzilla Grease Hose - 42 in.
- (2) 20V Lithium-Ion Rechargeable Batteries
- 1-Hour Quick Charger
- Automatic Air Bleeder
- 4-Jaw Coupler
- Shoulder Strap
- Carrying Case



L1388LFZ

GREASE GUN FEATURES:

- Rapid Reload™ Push Button Technology
 - For fast cartridge loading and unloading
 - Includes lightweight threadless grease barrel
- Flexzilla Grease Hose - 42 in.
 - Extreme cold-weather flexibility (subzero to 140°F)
 - Non-kink bend restrictor
- LED Light - Illuminate workspace
- Ergonomic Grip
- Non-slip Pads - Stabilize gun when standing up and laying on its side. Ideal for tight spaces
- Hose Dock - Secure and manage hose
- Lightweight Aluminum Barrel with Firm Grip Knurling - For better grip and durability
- Positive T-Grip Follower Handle
- Pressure Relief Valve
- 4-Jaw Coupler - Provides quality connection, disconnection, and sealing to zerk
- Holds 14 oz. Grease Cartridge (Cartridge not included)
- Delivers up to 7,000 psi

RAPID RELOAD™ PUSH BUTTON TECHNOLOGY

- For fast cartridge loading
(Patent Pending)



1 Press to release barrel



2 Slide barrel out to reload



L1388LFZ



L1388LFZ in Case



L1388LFZ-C

L1388LFZ-B

Part No.	Description	Retail Packaging
L1388LFZ	Flexzilla® 20V Cordless Grease Gun Kit	●
L1388LFZ-B	Flexzilla® 20V Lithium-Ion Rechargeable Battery for L1388LFZ	●
L1388LFZ-C	Flexzilla® 20V Lithium-Ion 1-Hour Quick Charger for L1388LFZ-B	●

Lever Action Grease Gun

The highest standards of engineering and craftsmanship are built into every Flexzilla® Grease Gun making them the choice for those who work in rugged conditions. Flexzilla Grease Hoses are more flexible than traditional rubber or thermoplastic hoses and stay flexible, even in subzero temperatures.

Heavy Duty Lever Action Grease Gun - Variable Stroke



FEATURES:

- Flexzilla 18 in. Grease Hose - Extreme cold-weather flexibility (subzero to 140°F)
- Soft Barrel Grip - Provides better ergonomic control and comfort
- Heavy-Duty Cast Head Construction - For maximum durability and longer service life
- Durable Follower Rod And Spring - For consistent priming
- Bleeder Valve - For purging unwanted air
- Variable Stroke - Allows grease delivery in confined areas
- 4-Jaw Coupler - Provides quality connection, disconnection, and sealing to zerk
- 3-Way Loading - Cartridge, bulk, filler nipple
- Wide Grip Clearance
- Holds 14 oz. Grease Cartridge
- Includes 6 in. angled extension

Part No.	Retail Packaging
L1355FZ	

Quick-Release Grease Coupler

The Flexzilla™ Quick-Release Grease Coupler features an innovative design which enables quick and easy connections to grease fittings, even in tight spaces. The Quick-Release Grease Coupler features a spring latch for positive engagement and allows for one-handed operation. When the fitting becomes pressurized, depress the thumb lever and release the coupler. No more stuck on couplers and broken grease fittings. Plus, the Quick-Release Grease Coupler eliminates grease spurts when disconnecting, keeping your workspace clean.

FEATURES:

- 6-Jaw Coupler with high strength steel jaws provide improved clamping force on the zerk
- Releases easily under high pressure
- Spring latch for positive engagement
- Ergonomic thumb lever provides effortless one-handed coupling and uncoupling, even under pressure - no more struggling when removing coupler
- Compact design is ideal for use in tight spaces, 2.9 in. long by 1.2 in. tall
- Compatible with all sizes and forms of mounts, fits all SAE and metric zerk fittings
- For use with most manual, battery and air operated grease guns and pumps

*Grease hose not included



Part No.	FNPT Fitting	Retail Packaging
L2050FZ	1/8 in.	



Grease Hoses

Flexzilla™ Grease Hoses are more flexible than traditional rubber or thermoplastic hoses and stay flexible, even in subzero temperatures.

FEATURES:

- Extreme cold-weather flexibility
- 10,000 psi working pressure
- For use with manual, battery or air operated grease guns
- Coupler sold separately



L2910FZ



L2925FZ



L2925FZSP



L2955FZSP



L2965FZSP

Part No.	Description	Hose I.D.	Hose Length	MNPT Fitting	Spring Guard	Retail Packaging
L2910FZ	Flexzilla® 12 in. Grease Hose	3/16 in.	12 in.	1/8 in.	–	●
L2925FZ	Flexzilla® 36 in. Grease Hose	3/16 in.	36 in.	1/8 in.	–	●
L2925FZSP	Flexzilla® 36 in. Grease Hose w/ Spring Guard	3/16 in.	36 in.	1/8 in.	Yes	●
L2955FZSP	Flexzilla® 18 in. Grease Hose w/ Spring Guard	1/8 in.	18 in.	1/8 in.	Yes	●
L2965FZSP	Flexzilla® 36 in. Grease Hose w/ Spring Guard	1/8 in.	36 in.	1/8 in.	Yes	●

Legacy™ BRANDS

FLEXZILLA®

PREMIUM HOSES, TOOLS & EQUIPMENT

flexzilla.com

COLORS™

SMARTFLEX®

ColorConnex®

Color Code System for Standard Interchanges

LOCK-N-LOAD™

THREADLESS BARREL GREASE GUNS

Workforce®

Hose Reel



Legacy

LEVELWIND

Levelwind™ Technology

This unique winding system automatically layers the hose back and forth across the reel. This ensures that the hose is coiled smoothly and easily every time.

Latching Mode Switch

Choose from latching hose every 3 ft. for extended use or switch to free run for immediate automatic rewinding

Levelwind™ Retractable Hose Reel

Levelwind™ Technology - This unique winding system automatically layers the hose back and forth across the reel ensuring that the hose is coiled smoothly, easily...every time. Levelwind reels include hose and lead-in hose.



L8310 - Levelwind™ Retractable Air Hose Reel, 3/8" x 100'

FEATURES:

- **Latching Mode Switch** - Choose from latching hose every 3 ft. for extended use or switch to free run for immediate automatic rewinding
- **Seven Position Locking Bracket** - These reels can swivel freely on the mounting bracket up to 135° or can be locked into place using the locking brace. Up to seven different locking angles can be utilized (L8300-W)
- **Adjustable Hose Stopper** - Increase or decrease the length of the hose that remains when the hose is fully retracted
- **Extra Large Swivel** - A 3/4 in. swivel reduces flow restrictions and allows for maximum flow
- **Freestanding Base** - Portable - Use freestanding or mounted on wall or ceiling. Flat base allows reel to rest on ground
- **Built-In Handle** - For carrying ease
- **Durable Construction** - Made from durable UV stabilized polypropylene
- **Hoses Included** - PVC or reinforced rubber twin hose and lead-in hose included
- **Assembled in USA of US and global components**

Levelwind™ Retractable Hose Reel (continued)



L8310



L8310 Retail Package

Part No.	Application	Hose I.D.	Hose Length
L8310	Air	3/8 in.	100 ft.

Hose Material	Working Pressure @ 70°F	Temperature Range (F°)
PVC	350 psi	15° to 150°

Hose Inlet	Hose Outlet	Weight
3/4 in.-11½ Male GHT	1/4 in. MNPT	31 lbs.

Lead-in Hoses and Mounting Brackets - Levelwind™ Reels

L8300-W FEATURES:

- Includes a seven position locking brace
- Reel can swivel freely on the mounting bracket up to 135° or can be locked into place using the locking brace
- Mounting options: Wall or overhead ceiling

L8300-B FEATURES:

- Includes a seven position locking brace
- Reel can swivel freely on the mounting bracket up to 360° or can be locked into place using the locking brace
- Up to seven different locking angles can be utilized
- Mounting options: High wall or bench



L8300-W



L8300-B



L8305LI



L8335LI

Part No.	Lead-in Hose For Part Number(s)	Application	Hose I.D.	Hose Length	Fittings	Hose Material	Working Pressure @ 70°F	Temperature Range (F°)	Retail Packaging
L8305LI	L8305, L8306, L8310	Compressed Air	3/8 in.	3 ft.	1/4 in. MNPT x 3/4 in.-11½ Female GHT	PVC	300 psi	40° to 140°	-
L8335LI	L8335	Air/Water	1/2 in.	3 ft.	1/2 in. MNPT x 3/4 in.-11½ Female GHT	PVC	300 psi	40° to 140°	-

Hoses



SMARTFLEX[®]

SmartFlex[®]

SmartFlex[®] Hybrid Polymer Blend hoses offer premium performance at a mid-level price point. SmartFlex offers quality and value.

SmartFlex® Air Hoses

SmartFlex® Air Hoses, From the Makers of Flexzilla®, feature a hybrid polymer blend material and provide premium performance at a mid-level price point. Smartflex air hoses are flexible in all-weather and have an abrasion-resistant outer cover for durability. Rugged bend restrictors reduce wear and tear, prolonging the life of the hose. SmartFlex air hoses offer quality and value and are an ideal choice for projects at home or on the job.

Air Hose Assemblies - Hybrid Polymer Blend FROM THE MAKERS OF FLEXZILLA®

HOSE FEATURES:

- All-weather flexibility
- Durable and abrasion-resistant outer cover
- Kink resistant under pressure
- Lightweight, coils easily
- Working pressure: 300 psi
- Temp. range: -30° to 140°F
- Nickel plated brass fittings



HSF3850BL2

Part No.	Color	Hose I.D.	Hose Length	Fittings	Retail Packaging
HSF3825BL2	Blue	3/8 in.	25 ft.	1/4 in. MNPT	●
HSF3850BL2	Blue	3/8 in.	50 ft.	1/4 in. MNPT	●

Air Hose Assemblies - Rubber FROM THE MAKERS OF FLEXZILLA®

SmartFlex® Rubber Air Hose, From the Makers of Flexzilla®, is designed with a Class C oil resistant EPDM rubber that resists heat, chemicals, and aging. The outer cover is abrasion resistant. The reinforced polyester rubber tube also provides additional strength. Rugged bend restrictors reduce wear and tear, prolonging the life of the hose. This hose is designed for a wide range of automotive, industrial, construction and agricultural applications.

HOSE FEATURES:

- Class C oil resistant EPDM rubber resists heat, chemicals and aging
- Durable and abrasion-resistant outer cover
- Polyester reinforced for additional strength
- Increased flexibility in cold weather
- Brass 1/4 in. MNPT fittings
- Working pressure: 300 psi
- Includes rugged bend restrictors that reduces wear and tear, prolonging the life of the hose



HSFR3850BK2

Part No.	Color	Hose I.D.	Hose Length	Fittings	Retail Packaging
HSFR3850BK2	Black	3/8 in.	50 ft.	1/4 in. MNPT	●



SmartFlex® Water Hoses

SmartFlex® Water Hoses, From the Makers of Flexzilla®, feature a hybrid polymer blend material and provide premium performance at a mid-level price point. Smartflex water hoses are flexible in all-weather and have an abrasion-resistant outer cover for durability. The large grip on the female end allows you to use the power of your entire hand to make tight, leak free connections. The inner tube material is drinking water safe. SmartFlex is an adaptable, swivel-handle water hose that is an ideal choice for use around your home and lawn.

Garden & RV/Marine Hose Assemblies

FROM THE MAKERS OF **FLEXZILLA®**

FEATURES:

- All-weather flexibility
- Kink resistant under pressure
- Lightweight, coils easily
- Abrasion-resistant outer cover
- Tight leak free connections – A large grip lets you use the power of your entire hand to make tight connections easy
- Durable O-ring - Provides long lasting leak free connections
- Drinking water safe



HSFG550GR



HSFRV550



Part No.	Color	Hose I.D.	Hose Length	Fittings	Packaging Type	
HSFG550GR	Green	5/8 in.	50 ft.	3/4 in. - 1 1/2" GHT	●	●
HSFG5100GR	Green	5/8 in.	100 ft.	3/4 in. - 1 1/2" GHT	●	
HSFRV425	White	1/2 in.	25 ft.	3/4 in. - 1 1/2" GHT	●	
HSFRV450	White	1/2 in.	50 ft.	3/4 in. - 1 1/2" GHT	●	
HSFRV525	White	5/8 in.	25 ft.	3/4 in. - 1 1/2" GHT	●	
HSFRV550	White	5/8 in.	50 ft.	3/4 in. - 1 1/2" GHT	●	

● Retail packaging (English only)

● Individually boxed no retail packaging with suffix -CA

Workforce® Air Hose & Kit

Workforce® PVC Air Hoses are made from virgin resin PVC, giving them excellent flexibility and low temperature resistance. The outer cover also uses virgin resin PVC that is UV, oil, and abrasion resistant. The inner tube is reinforced with extra strong polyester braiding which is 20% lighter per foot than comparable rubber hoses. The Workforce air hoses resist cracking and fading. If coupling, use crimped-on fittings only. Reusable fittings not recommended.

PVC & Rubber Air Hose Assemblies

PVC HOSE FEATURES:

- Outer cover and inner tube are made from the highest quality PVC materials
- Temp. Range: 15° to 150°F
- Twin Spiral Braiding - Extra strong polyester textile cord adds reinforcement to inner tube
- Cover is oil and abrasion-resistant and non-marring
- Includes bend restrictors that reduces wear and tear, prolonging the life of the hose
- Corrosion-resistant solid brass NPT fittings

RUBBER HOSE FEATURES:

- Construction:
 - Tube - RMA Class C (Medium oil-resistance)
 - Cover - Synthetic rubber
- Temp. range: -20° to 140°F
- Working pressure: 300 psi

Part No.	Color	Hose I.D.	Hose Length	Working Pressure @ 70°F	Fittings	Retail Pkg
PVC Air Hose Assemblies						
HWF3825BL2	Blue	3/8 in.	25 ft.	350 psi	1/4 in. MNPT	●
HWF3850BL2	Blue	3/8 in.	50 ft.	350 psi	1/4 in. MNPT	●
Rubber Air Hose Assemblies						
HRE1225RD3	Red	1/2 in.	25 ft.	300 psi	3/8 in. MNPT	●
HRE1250RD3	Red	1/2 in.	50 ft.	300 psi	3/8 in. MNPT	●
HRE3825RD2	Red	3/8 in.	25 ft.	300 psi	1/4 in. MNPT	●
HRE3850RD2	Red	3/8 in.	50 ft.	300 psi	1/4 in. MNPT	●



Truck Tire Inflator Kit - Include Hose, Glad-hand and Chuck

Workforce® truck tire inflator kit use truck's on-board air supply to inflate tires in remote situations.

Part No.	Color	Hose I.D.	Hose Length	Fittings	Retail Packaging
HGH2	Blue	3/8 in.	50 ft.	1/4 in. MNPT	-

HGH2 KIT INCLUDES:

- Glad-hand attachment, 30° dual angle and straight-on air chuck



Air Line Accessories

The ColorConnex® System

ColorConnex is a patented system that allows color-to-color matching of couplers and plugs among the standard pneumatic interchanges.

ColorConnex®

ColorConnex®



ColorConnex® is a patented system that allows color-to-color matching of couplers and plugs among the standard pneumatic interchanges.

- Industrial (Type D): Red
- Automotive (Type C): Blue
- ARO (Type B): Green

By using **ColorConnex** to dedicate line use, you can ensure you never use a lubricated line for a dry line application, preventing cross contamination.

- **Match coupler and plug types**
- **Dedicate hose applications**



Industrial Interchange

Couplers, Plugs and Kits

Part No.	Color	Type	Interchange	Connection Size	Body Size	Max. Pressure	Material	Retail Packaging
ColorConnex® Couplers								
A73410D	Red	D	Industrial	1/4 in. FNPT	1/4 in.	300 psi	Steel/Aluminum*	●
A73420D	Red	D	Industrial	1/4 in. MNPT	1/4 in.	300 psi	Steel/Aluminum*	●
ColorConnex® Plugs								
A73430D-2PK	Red	D	Industrial	1/4 in. FNPT	1/4 in.	300 psi	Aluminum*	●
A73440D-2PK	Red	D	Industrial	1/4 in. MNPT	1/4 in.	300 psi	Aluminum*	●

*6061-T6 Aircraft Aluminum



Part No.	Color	Type	Interchange	Connection Size	Body Size	Max. Pressure	Material	Contents	Bulk Quantity	Retail Pkg
ColorConnex® 3-Pc. Coupler and Plug Kit										
A73452D	Red	D	Industrial	1/4 in. NPT	1/4 in.	300 psi	Steel/Aluminum*	(1) FNPT Coupler, (1) FNPT Plug and (1) MNPT Plug	N/A	●
ColorConnex® 7-Pc. Coupler and Plug Kit										
A73457D	Red	D	Industrial	1/4 in. NPT	1/4 in.	300 psi	Steel/Aluminum*	(1) FNPT Coupler, (1) MNPT Coupler, (2) FNPT Plugs and (3) MNPT Plugs	N/A	●
ColorConnex® 14-Pc. Coupler and Plug Kit										
A73458D	Red	D	Industrial	1/4 in. NPT	1/4 in.	300 psi	Steel/Aluminum*	(2) FNPT Couplers, (2) MNPT Couplers, (4) FNPT Plugs and (6) MNPT Plugs	N/A	●

*6061-T6 Aircraft Aluminum



Automotive Interchange

Couplers, Plugs and Kits

Part No.	Color	Type	Interchange	Connection Size	Body Size	Max. Pressure	Material	Retail Packaging
ColorConnex® Couplers								
A72410C	Blue	C	Auto	1/4 in. FNPT	1/4 in.	300 psi	Steel/Aluminum*	●
A72420C	Blue	C	Auto	1/4 in. MNPT	1/4 in.	300 psi	Steel/Aluminum*	●
ColorConnex® Plugs								
A72430C-2PK	Blue	C	Auto	1/4 in. FNPT	1/4 in.	300 psi	Aluminum*	●
A72440C-2PK	Blue	C	Auto	1/4 in. MNPT	1/4 in.	300 psi	Aluminum*	●

*6061-T6 Aircraft Aluminum



Part No.	Color	Type	Interchange	Connection Size	Body Size	Max. Pressure	Material	Contents	Bulk Quantity	Retail Pkg
ColorConnex® 3-Pc. Coupler and Plug Kit										
A72452C	Blue	C	Auto	1/4 in. NPT	1/4 in.	300 psi	Steel/Aluminum*	(1) FNPT Coupler, (1) FNPT Plug and (1) MNPT Plug	N/A	●
ColorConnex® 7-Pc. Coupler and Plug Kit										
A72457C	Blue	C	Auto	1/4 in. NPT	1/4 in.	300 psi	Steel/Aluminum*	(1) FNPT Coupler, (1) MNPT Coupler, (2) FNPT Plugs and (3) MNPT Plugs	N/A	●
ColorConnex® 14-Pc. Coupler and Plug Kit										
A72458C	Blue	C	Auto	1/4 in. NPT	1/4 in.	300 psi	Steel/Aluminum*	(2) FNPT Couplers, (2) MNPT Couplers, (4) FNPT Plugs and (6) MNPT Plugs	N/A	●

*6061-T6 Aircraft Aluminum



ARO Interchange

Couplers, Plugs and Kits

Part No.	Color	Type	Interchange	Connection Size	Body Size	Max. Pressure	Material	Retail Packaging
ColorConnex® Couplers								
A71410B	Green	B	ARO	1/4 in. FNPT	1/4 in.	300 psi	Steel/Aluminum*	●
A71420B	Green	B	ARO	1/4 in. MNPT	1/4 in.	300 psi	Steel/Aluminum*	●
ColorConnex® Plugs								
A71430B-2PK	Green	B	ARO	1/4 in. FNPT	1/4 in.	300 psi	Aluminum*	●
A71440B-2PK	Green	B	ARO	1/4 in. MNPT	1/4 in.	300 psi	Aluminum*	●

*6061-T6 Aircraft Aluminum



Part No.	Color	Type	Interchange	Connection Size	Body Size	Max. Pressure	Material	Contents	Bulk Quantity	Retail Pkg
ColorConnex® 3-Pc. Coupler and Plug Kit										
A71452B	Green	B	ARO	1/4 in. NPT	1/4 in.	300 psi	Steel/Aluminum*	(1) FNPT Coupler, (1) MNPT Plug and (1) FNPT Plug	N/A	●
ColorConnex® 7-Pc. Coupler and Plug Kit										
A71457B	Green	B	ARO	1/4 in. NPT	1/4 in.	300 psi	Steel/Aluminum*	(1) FNPT Coupler, (1) MNPT Coupler, (2) FNPT Plugs and (3) MNPT Plugs	N/A	●
ColorConnex® 14-Pc. Coupler and Plug Kit										
A71458B	Green	B	ARO	1/4 in. NPT	1/4 in.	300 psi	Steel/Aluminum*	(2) FNPT Couplers, (2) MNPT Couplers, (4) FNPT Plugs and (6) MNPT Plugs	N/A	●

*6061-T6 Aircraft Aluminum



Blow Guns & Tire Maintenance



Blow Guns

Ideal for applications in the garage, shop and worksite.

Workforce® Blow Guns



Blow Guns featuring our telescoping extension improves reach without refitting the gun. Maximum inlet air pressure: 110 psi.

AG2-10

FEATURES:

- 360° Adjustable Length Extension
- Locks at any length between 6.5 and 11 in.
- Ideal for tight or hard-to-access spaces
- Includes a threaded removable rubber tip

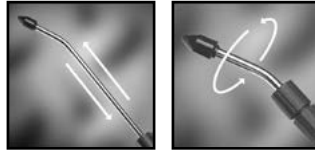

AG4-10

FEATURES:

- Dual air chuck
 - Has a unique design that allows for the purging of moisture from air lines prior to inflating tires
- Doubles as a blow gun
 - Simply pull the trigger on handle for a steady stream of air



Part No.	Inlet FNPT	Overall Length	Nozzle	Max. dBA	Air Consumption (SCFM)	Body Material	Retail Pkg
AG2-10*	1/4 in.	12.5 in. to 17.5 in.	Rubber	87	13	ABS	●
AG4-10*	1/4 in.	11.5 in.	Rubber	87	13	ABS	●

*U.S. Pat. No. D562,661 S and 6,698,672 B1
 **U.S. Pat. No. D562,661 S, 6,698,672 B1 and 6,561,233 B2

Lever-trigger blow guns for most frequent-use applications. Can be disassembled for cleaning or repair using common o-rings.

Part No.	Description	Inlet FNPT	Outlet NPSM Female	Overall Length	Max. dBA	Air Consumption (SCFM)	Max. Inlet Pressure	Material	Color	Retail Packaging
AG7	Lever Blow Gun with Rubber Tip	1/4 in.	1/8 in.	5 in.	87	11	150 psi	Plated Zinc	Chrome	●

Workforce® Tire Gauges

Proper tire pressure is critical to maximizing the performance and life of tires. It also increases gas mileage, improves vehicle handling and helps prevent blowouts.



Heavy-Duty Truck and Bus Straight-On Dual Head Tire Pressure Gauge

FEATURES:

- Reads from 10 to 150 psi
- Reverse dual foot head simplifies reading pressure on inner dual wheels



Dual Foot Tire Inflator

FEATURES:

- Air inflator provides user with easy controlled inflation
- For use with direct lines
- Chrome plated steel dual chuck, 6 in.
- Die-cast zinc alloy body with heavy-duty brass valves
- Easy to read recessed glass sight pressure gauge
- Indicator bar calibrated in 2 psi increments from 10 to 120 psi
- Heavy-duty rubber hose, 12 in.
- Lightweight, yet stands the pounding of hard surfaces
- 1/4 in. FNPT

Greasing Equipment

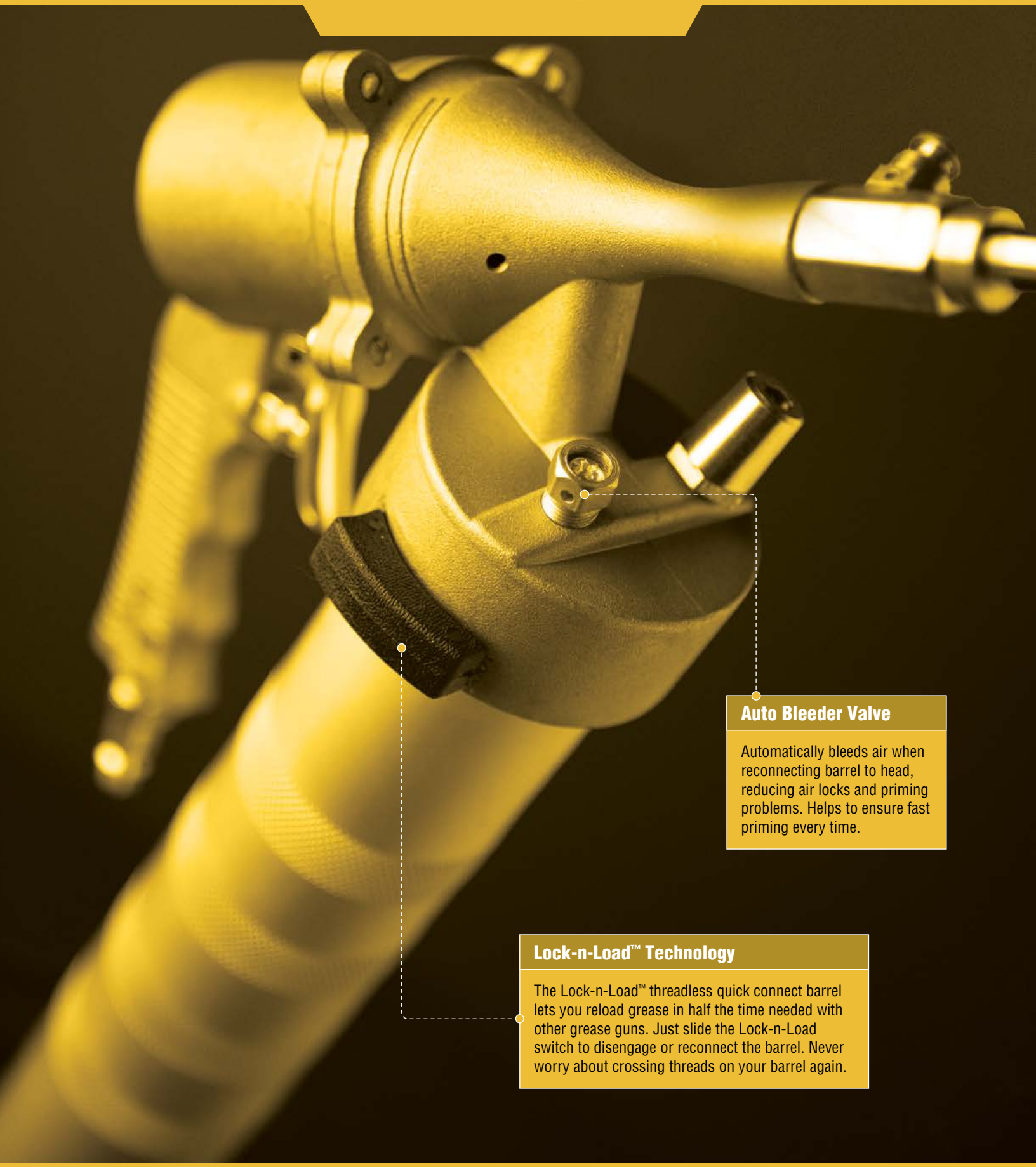

Auto Bleeder Valve

Automatically bleeds air when reconnecting barrel to head, reducing air locks and priming problems. Helps to ensure fast priming every time.

Lock-n-Load™ Technology

The Lock-n-Load™ threadless quick connect barrel lets you reload grease in half the time needed with other grease guns. Just slide the Lock-n-Load switch to disengage or reconnect the barrel. Never worry about crossing threads on your barrel again.

Lock-n-Load™ Grease Guns



LOCK-N-LOAD™

THREADLESS BARREL GREASE GUNS

Lock-n-Load™ technology is Legacy's first-in-the-industry system for fast grease reloading. The Lock-n-Load threadless quick connect barrel lets you reload grease in half the time compared to other grease guns. Just slide the Lock-n-Load switch to disengage or reconnect the barrel. Never worry about crossing threads on your barrel again, and get fast priming every time.

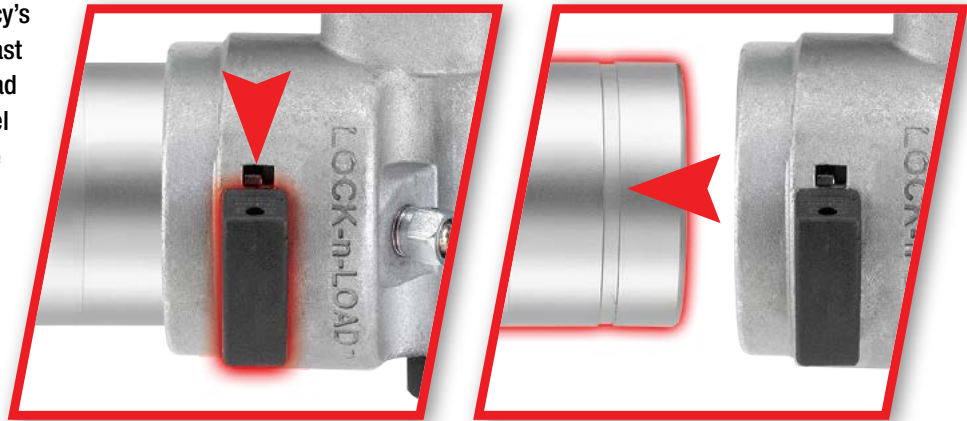

RELOAD 2X FASTER

COMPARED TO THREADED BARREL GREASE GUNS

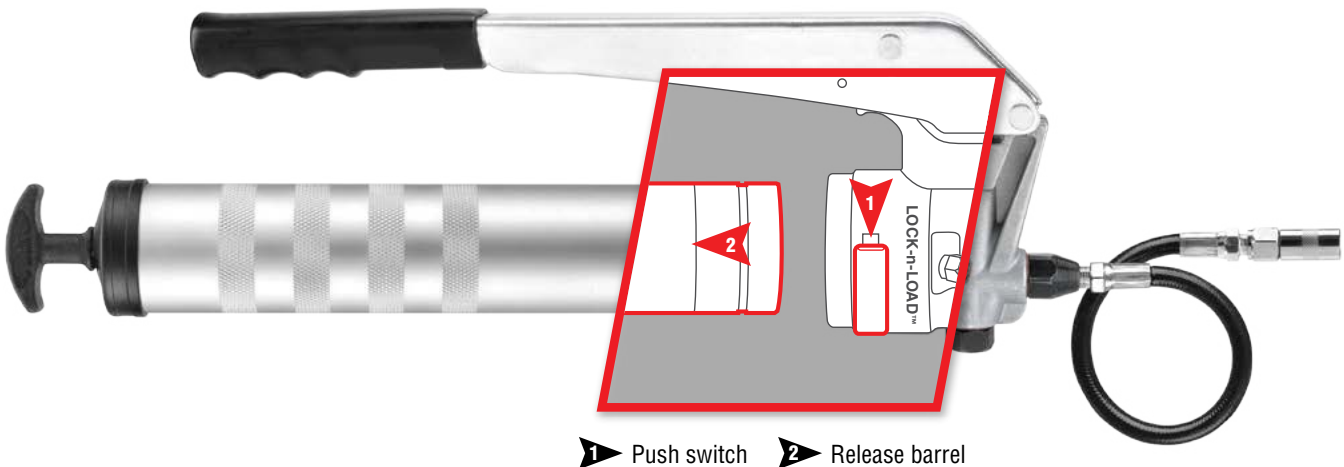

Lock-n-Load™ Grease Guns (continued)

COMMON FEATURES:

- Lock-n-Load™ threadless quick connect barrel allows you to reload grease in half the time compared to other grease guns
- Automatic Bleeder Valve - Bleeds air when reconnecting barrel to head. Reduces air locks and priming problems
- Heavy-duty Die-cast Head Construction - For maximum durability and longer service life
- 3-Way Loading - Cartridge, bulk, filler nipple
- Lightweight Aluminum Barrel with Firm Grip Knurling - For better grip and durability
- Ergonomic T-grip follower handle
- Holds 14 oz. grease cartridge



L1045L

L1045L - Lever Action Grease Gun

VARIABLE STROKE

- Allows grease delivery where short strokes are needed

FEATURES:

- Delivers up to 10,000 psi
- Protected Piston and Smooth Action Lever - The unique roller glide piston provides a low friction lever action. By not pinning the lever to the piston like the competition, damage to the piston is prevented if the gun is dropped
- Handle fully extended to 45° permits use in tight spaces
- Reinforced handle to withstand demanding environments and rough handling
- Spring loaded handle to facilitate one handed operation
- Handle Lock - Prevents discharge of grease during storage or when working in tight spaces. During use, lock can be stored in handle
- Includes: 4-Jaw coupler for better grip and longer service life, 12 in. flexible grease hose for hard-to-reach grease fittings and 6 in. angled extension
- Strokes per ounce = 26



L1075L

L1075L - Pistol Grip Grease Gun

VARIABLE STROKE

- Allows grease delivery where short strokes are needed

FEATURES:

- Delivers up to 5,000 psi
- Includes: 4-Jaw coupler for better grip and longer service life, 12 in. flexible grease hose for hard-to-reach grease fittings and 6 in. straight extension
- Strokes per ounce = 32

Workforce® Suction Gun



L1700 - Suction Gun

FEATURES:

- Heavy-duty follower for positive suction
- Ergonomic grip follower handle
- Flexible vinyl hose for hard-to-reach areas
- Non-slip knurled barrel for better grip
- 16 oz. capacity

Workforce® Grease Guns

The highest standards for engineering and craftsmanship are built into every Workforce® grease gun making them the choice for those who work under rugged conditions!



L1380 - 12V Cordless Grease Gun Kit

FEATURES:

- Delivers up to 6,000 psi
- No manual pumping required
- Machined and hardened piston
- Cartridge and bulk loading
- Powerful 12V motor
- Planetary gear drive
- Plated steel barrel
- Includes: 30 in. flexible grease hose for hard-to-reach grease fittings, 4-Jaw coupler for better grip and longer service life, 1 hour quick-charger, two Ni-Cd rechargeable 12V batteries, shoulder strap, and carrying case - durable case for long-lasting protection and storage
- Ounces per minute = 1.90



L1380



L1380-B

Retail Pkg.



L1380-C

Retail Pkg.



Part No.	Description	Part No.	Description
L1380-B	Replacement battery	L1380-C	Replacement battery charger

Workforce® Grease Guns (continued)



L1305

L1305 - Mini Grease Gun

FEATURES:

- 3 oz. cartridge loading
- Chrome finish
- Includes: 4-Jaw coupler for better grip and longer service life, 12 in. flexible grease hose and 4 in. straight extension
- Strokes per 0.5 ounce = 54



L1310

L1310 - Lever Grease Gun

FEATURES:

- 2-Way Loading - Cartridge or bulk
- Filler nipple port for loading grease
- Positive-grip follower handle with locking tab
- Includes: 4-Jaw coupler for better grip and longer service life and 6 in. angled extension
- Strokes per ounce = 28



L1320

L1320 - Pistol Grip Grease Gun

FEATURES:

- Filler nipple port for loading grease
- Positive-grip follower handle
- Includes: 4-Jaw coupler for better grip and longer service life and 6 in. straight extension
- Holds 14 oz. grease cartridge
- Strokes per ounce = 41

Workforce® Pro Grease Guns (continued)



L1025

L1025 - Dual Setting Lever Action Grease Gun

FEATURES:

- Dual Setting
 - High Volume/Low Pressure
 - Strokes per ounce = 14
 - High Pressure/Low Volume
 - High pressure mode – 8,000 to 10,000 psi (helps clear clogged fittings)
- Bleeder valve for purging unwanted air
- 2-Way loading - Cartridge and bulk
- Positive T-grip follower handle
- Includes: 4-Jaw coupler for better grip and longer service life and 6 in. angled extension



L1325

L1325 - Heavy-Duty Pistol Grip Grease Gun

FEATURES:

- 2-Way Loading - Cartridge or bulk
- Filler nipple port for loading grease
- Positive-grip follower handle
- Includes: 4-Jaw coupler for better grip and longer service life, 12 in. flexible grease hose and 6 in. straight extension
- Strokes per ounce = 41



L1355

L1355 - Heavy-Duty Lever Action Grease Gun

FEATURES:

- Includes: (2) 4-Jaw couplers, 12 in. flexible grease hose and 6 in. angled extension
- Strokes per ounce = 24

Workforce™ Grease Couplers

High pressure grease couplers for manual and air operated equipment. These couplers are equipped with 1/8 in. ends and hardened precision fit jaws for extended service life.

Part No.	Description	Pressure	Quick Connect Compatible	Retail Packaging
L2010	Workforce™ Grease Coupler, 4-Jaw, Ball Check	6,000 psi	Yes	●
L2010-2PK	Workforce™ Grease Coupler, 4-Jaw, Ball Check, 2-Pack	6,000 psi	Yes	●
L2015	Lock-n-Load™ Grease Coupler, 4-Jaw, High Pressure	10,000 psi	Yes	●
L2020	Workforce™ Grease Coupler, 3-Jaw, High Pressure, Large Style	10,000 psi	No	●



L2100-1 - Grease Coupler, Needle-Point, Hypodermic Type

FEATURES:

- For boots or sealed bearings
- Includes a protective plastic cover
- 18 gauge needle
- For use with manual guns only



L2110 - Grease Coupler, Needle-Point, Straight

FEATURES:

- Allows operator to contact flush type or hard-to-reach hydraulic type fittings
- Threads 1/8 in. FNPT



L2130 - Grease Coupler, Seal-Off/Rubber Tip

FEATURES:

- Used for lubricating cars with greasing plugs, spindles and U-Joints
- Threads 1/8 in. FNPT
- Oil and grease resistant rubber tip
- For use with manual guns only

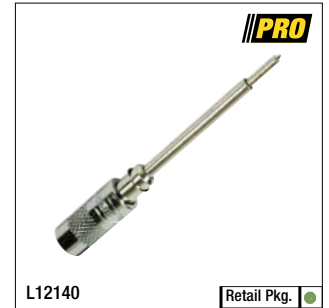

L12140 - Grease Coupler, 3 in. Needle-Point, Straight

FEATURES:

- Needle type coupler for flush type or hard-to-reach fittings
- Quick connect
- Ideal for 4-wheel drive vehicles
- Excellent on CV joints



L2040 - Grease Coupler, Right Angle, Slide-on

FEATURES:

- Angle adapter specifically made for compact, subcompact and 4-wheel drive vehicles
- Ideal for working in tight areas

Workforce™ Grease Hoses

Standard-Duty Rubber Grease Hose Features:

- SAE100R1 single steel wire braid grease hose with oil-resistant cover
- Operational Temp.: -40° to 190°F
- Heavy-duty, high quality 1/8 in. MNPT fittings
- For manual operated grease guns only

Thermoplastic Grease Hose Features:

- SAE100R7 thermoplastic grease hose
- 12,000 psi burst pressure
- Heavy-duty, high quality 1/8 in. MNPT fittings
- For manual operated grease guns only

Part No.	Description	Hose I.D.	Hose Length	Working Pressure	Coupler	Spring Guard	Retail Packaging
L2210-1	Grease Hose, 18 in. Steel Braid/Rubber	3/16 in.	18 in.	3,000 psi	N/A	No	●
L2270-1	Grease Hose, 12 in. Thermoplastic	1/8 in.	12 in.	3,000 psi	N/A	No	●
L2270SP-1	Grease Hose, 12 in. Thermoplastic Spring Guard	1/8 in.	12 in.	3,000 psi	N/A	Yes	●
L2275-1	Grease Hose, 18 in. Thermoplastic	1/8 in.	18 in.	3,000 psi	N/A	No	●
L2275SP-1	Grease Hose, 18 in. Thermoplastic, Spring Guard	1/8 in.	18 in.	3,000 psi	N/A	Yes	●
L2285SP-1	Grease Hose, 36 in. Thermoplastic, Spring Guard	3/16 in.	36 in.	3,000 psi	N/A	Yes	●



L2210-1 Retail Package



L2270-1



L2270SP-1

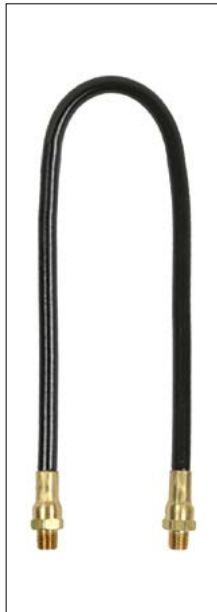

L2275-1



L2275SP-1



L2285SP-1 Retail Package

Workforce™ Grease Accessories, Repair Tools & Oil Pump



GCB12

Retail Pkg.

GCB12 - Porta-Pak™ 12-Pack Grease and Caulk Tube Storage Box

FEATURES:

- Protected storage for 12 tubes of grease and/or caulk

- Adjustable shoulder strap
- Stores tubes in upright position
- Damage and weather-resistant
- Made with high-impact plastic construction
- Grease cartridges and caulk not included



L2470

Retail Pkg.

L2470 - Grease Gun Holder

FEATURES:

- Attach holder to workbench, pegboard or most any area designed for grease or suction guns with 2-1/4 in. OD barrels



L2475

Retail Pkg.

L2475 - Bearing Packer

FEATURES:

- Will pack any bearing up to 5 in. OD while forcing out old grease
- Can be used with any Legacy grease gun except the L1305



L5960

Retail Pkg.

L5960 - All-In-One Repair Tool, 1/4 in. - 28

FEATURES:

- Re-taps 1/4 in. - 28 threads
- Installs 5/16 in. and 3/8 in. hex straight or angle-type fittings
- Removes 5/16 in. and 3/8 in. hex straight or angle-type fittings
- “Easy-out” removes broken 1/4 in. NPT fittings



L5970

Retail Pkg.

L5970 - All-In-One Repair Tool, 1/8 in. NPT Fittings

FEATURES:

- Re-taps 1/8 in. NPT threads
- Installs 7/16 in. and 3/8 in. hex straight or angle-type fittings
- Removes 7/16 in. and 3/8 in. hex straight or angle-type fittings
- “Easy-out” removes broken 1/8 in. NPT fittings



L3000

Retail Pkg.

L3000 - Lever Action Barrel Pump

FEATURES:

- Die-cast head with steel piston and brass segments which assures long life and durability
- Fits 16-55 gal. drums with standard 2 in. bung openings
- Telescopic suction tube dispenses petroleum-based fluids
- Curved discharge spout with garden hose threads
- Dispenses 10 oz. per stroke



L2440

Retail Pkg.

L2440 - Grease Extension, 6 in. Angled

FEATURES:

- Thread size 1/8 in. MNPT

Workforce™ Standard, Metric & Drive Grease Fittings

Part No.	Description	Thread Size	Retail Packaging
L5001	Grease Fittings, 1/4 in. - 28 Straight, 10-Pc.	1/4 in. -28 Thread	●
L5031	Grease Fittings, 45° 1/4 in. - 28 Straight, 10-Pc.	1/4 in. -28 Thread	●
L5211	Grease Fittings, 1/8 in. Straight PTF, 10-Pc.	1/8 in. NPT	●
L5221	Grease Fittings, 45° 1/8 in. PTF, 10-Pc.	1/8 in. NPT	●
L5401	Grease Fittings, Metric, 5-Pc.	6mm x 1 Straight	●
L5501	Grease Fittings, Metric, 5-Pc.	8mm x 1 Straight	●
L5601	Grease Fittings, Drive Type, 10-Pc.	3/16 in. Straight	●
L5621	Grease Fittings, Drive Type, 10-Pc.	5/16 in. Straight	●
L5701	Grease Fittings, Metric, 5-Pc.	10mm. x 1 Straight	●

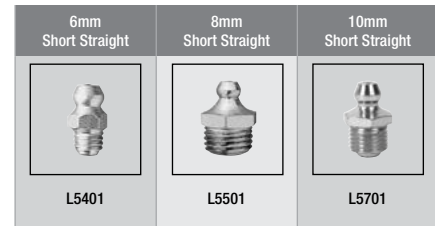
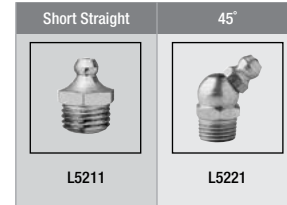
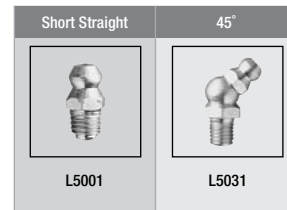

L5900 - Grease Fitting Assortment, Standard, 8-Pc.

- 3 most common fittings for domestic and foreign cars and trucks, comes in a clam-pack container

L5950 - Grease Fitting Assortment, Standard, 96-Pc.

- 6 most popular 1/4 in. - 28 and 1/8 in. MNPT fitting sizes contained in a refillable plastic box

L5910 - Grease Fitting Assortment, Metric, 8-Pc.

- 6 mm assortment contains most common fittings used when replacing damaged fittings or converting from plugs, comes in a clam-pack container

L5990 - Grease Fitting Assortment, Metric, 96-Pc.

- 9 most popular 6 mm, 8mm and 10 mm fitting sizes contained in a refillable plastic box

Part No.	Description - Standard	Contents			Retail Packaging
L5900	Grease Fitting Assortment - Standard 8-Pc.	4 - 1/4 in. - 28, Short Straight	2 - 1/4 in. - 28, 45°	2 - 1/4 in. - 28, 90°	●
L5950	Grease Fitting Assortment - Standard 96-Pc.	24 - 1/4 in. - 28, Short Straight	12 - 1/4 in. - 28, 45°	12 - 1/4 in. - 28, 90°	●
		24 - 1/8 in. NPT, Short Straight	12 - 1/8 in. NPT, 45°	12 - 1/8 in. NPT, 90°	
Part No.	Description - Metric	Contents			Retail Packaging
L5910	Grease Fitting Assortment - Metric 8-Pc.	4 - M6 x 1 Thread, Short Straight	2 - M6 x 1 Thread, 45°	2 - M6 x 1 Thread, 90°	●
L5990	Grease Fitting Assortment - Metric 96-Pc.	40 - M6 x 1 Thread, Straight	6 - M6 x 1 Thread, 45°	6 - M6 x 1 Thread, 90°	●
		10 - M8 x 1 Thread, Straight	6 - M8 x 1 Thread, 45°	6 - M8 x 1 Thread, 90°	
		10 - M10 x 1 Thread, Straight	6 - M10 x 1 Thread, 45°	6 - M10 x 1 Thread, 90°	

PLAN-O-GRAMS

ONE-STOP SHOP

All the high-performance tools you need for that big project in one spot.

FLEXITOL
Premium tools, drills & attachments

Air Hoses, Reels and Accessories

Items Shown:

- Recoil Hoses
- Whip Hoses
- Tire Inflators
- Pro High Flow Couplers and Plugs
- Pro Reusable Fittings and Splicers
- Air Hoses
- Pro Air Hoses – Field Repairable
- Air Hose Reels
- Extension Cord Reels



Air Hoses, Tools and Accessories

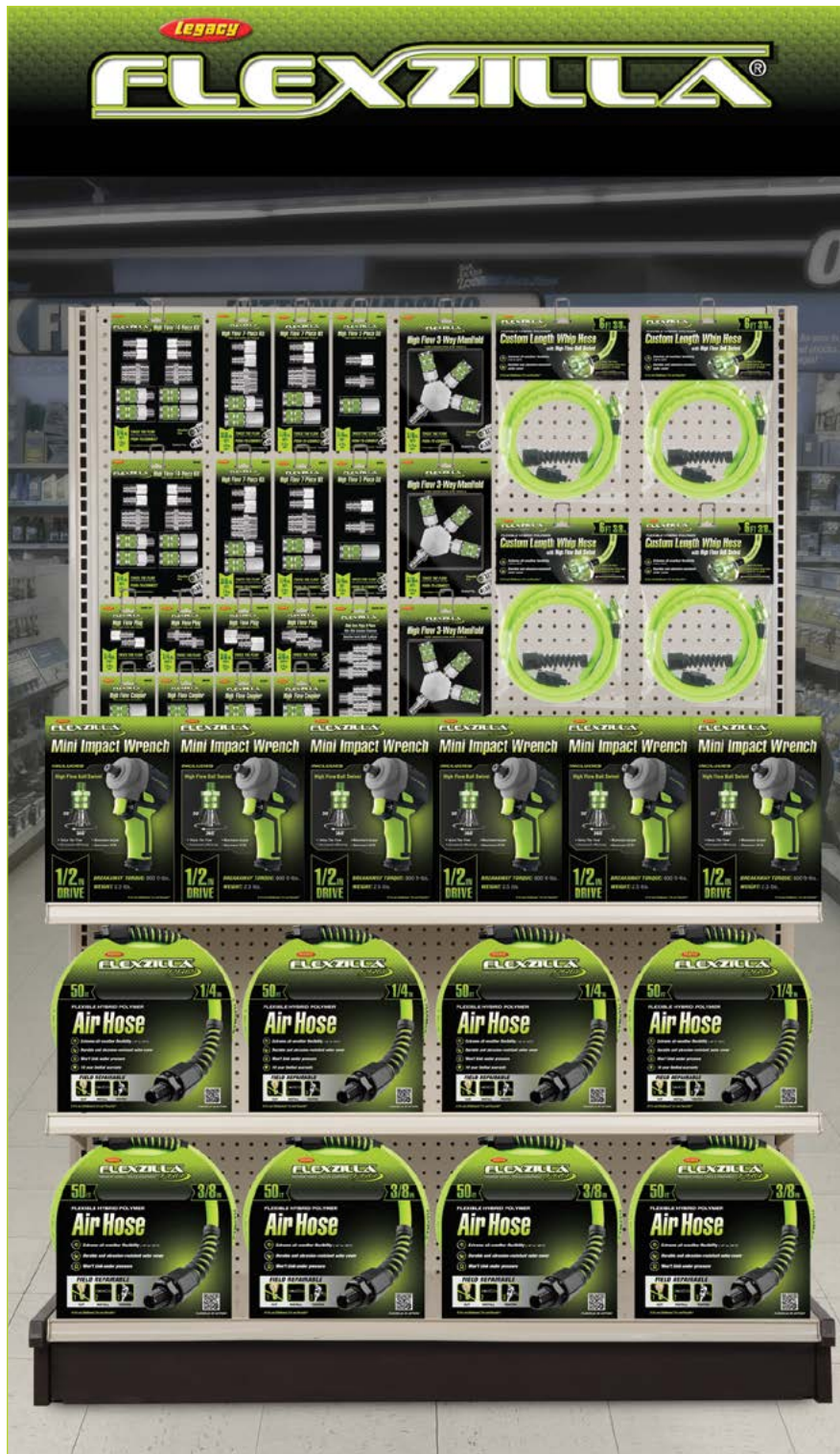

Items Shown:

- Pro High Flow Couplers and Plugs
- Pro Custom Length Whip Hoses
- Pro Mini Impact Wrench
- Pro Air Hoses – Field Repairable

Blow Guns and Assorted Products

Items Shown:

- Blow Guns and Kits
- Pro Extension Cords
- 11-Piece Air Hose Compressor Kits
- Truck Tire Inflator Kits
- Air Hose Reels with Levelwind™ Technology
- Extension Cord Reels

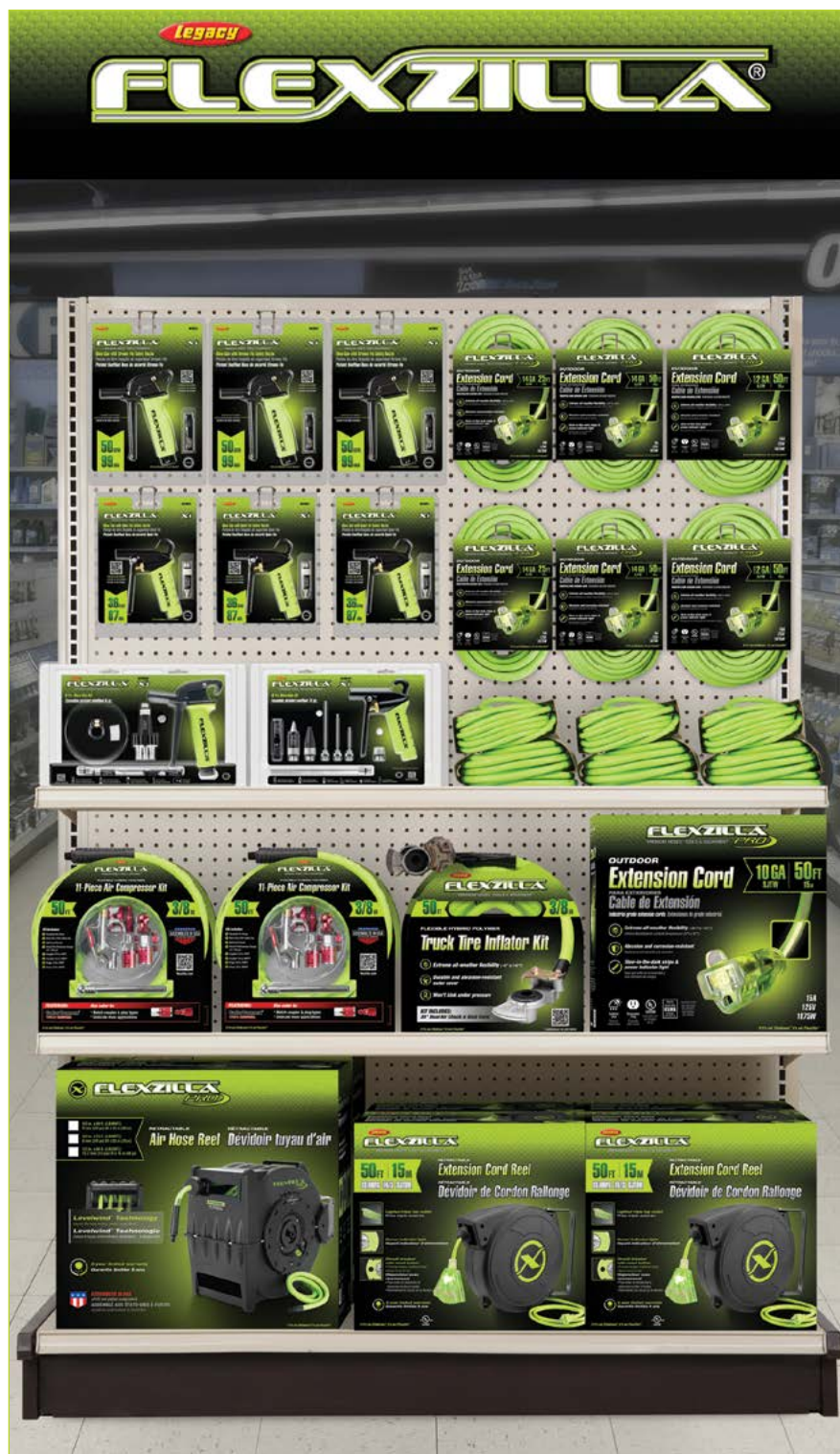

Greasing Equipment



Items Shown:

- Grease Hoses
- Grease Guns – Lever Action
- Grease Guns – 20V Cordless Kit

Custom Hose Center

Items Shown:

- Reusable Fittings and Splicers
- Bulk Air Hose
- Bulk Water Hose

3 EASY STEPS

 **FIELD REPAIRABLE**



1

CUT – Measure and cut desired length of hose at 90° angle.



2

INSTALL – Slide spiral fitting and nut onto hose. Push hose onto fitting until hose reaches threads.



3

TIGHTEN – Tighten fitting nut until snug. Slide bend restrictor up and snap onto nut.

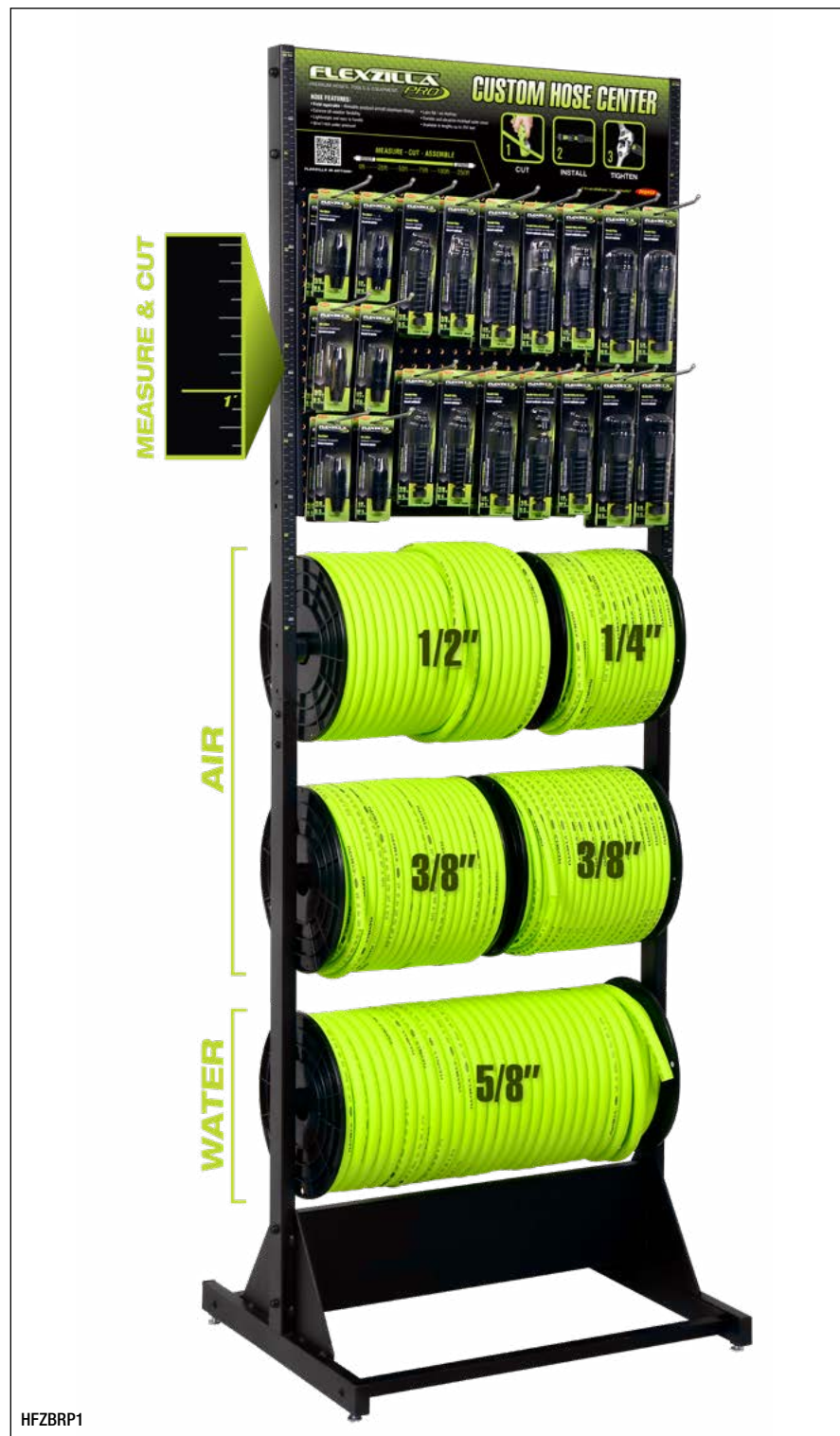

HFZBRP1

Water Hoses, Reels and Nozzles



Items Shown:

- Garden Hose Nozzles
- 3-Piece Nozzle Kit with Quick Connections
- Quick-Connect Garden Hose Fittings
- Pro Water Hose Nozzles
- Garden Lead-in Hoses
- Pressure Washer Hoses
- SwivelGrip® Garden Hoses
- Garden Hoses
- Garden Hose 5-Pc. Kits with Quick Connect Attachments
- Pro Water Hoses – Field Repairable
- Water Hose Reels with Levelwind Technology™

Garden Hose Center

Items Shown:

- SwivelGrip® Garden Hoses
- Garden Hoses
- Garden Hose Kits with Quick Connect Attachments
- Colors SwivelGrip® Garden Hoses
- SmartFlex® Garden Hoses
- SmartFlex® RV/Marine Hoses



Colors™ SwivelGrip® Hoses



Items Shown:

- Colors™ SwivelGrip® Garden Hoses
- Available in Colors:
 - Brown Mulch
 - Forest Green
 - Red Clay
 - Slate Gray

SmartFlex® Air, Garden and RV/Marine Hoses

Items Shown:

- Hybrid Air Hoses
- Rubber Air Hoses
- RV/Marine Hoses
- Garden Hoses



ColorConnex® Couplers, Plugs and Kits



Items Shown:

- ColorConnex Couplers, Plugs & Kits
- Industrial (Type D): Red
- Automotive (Type C): Blue
- ARO (Type B): Green

Workforce® and Lock-n-Load® Greasing Equipment

Items Shown:

- Grease Fittings
- Large Style Couplers
- 4-Jaw Couplers
- Grease Fitting Kits
- Grease Extensions
- Needle Point Couplers
- 3-Jaw Couplers
- Grease Gun Brackets
- Grease Fitting Repair Tools
- Grease Couplers
- Grease Whip Hoses
- Bearing Packers
- Workforce Grease Guns
- Lock-n-Load Grease Guns



Part No.	Pg.
A53416FZ	37
A53426FZ	37
A53430FZ-2PK	37
A53440FZ-2PK	37
A53440FZBS	37
A53452FZ	38
A53457FZ	38
A53458FZ	38
A53616FZ	37
A53626FZ	37
A53630FZ-2PK	37
A53640FZ-2PK	37
A53657FZ	38
A55618FZ	40
A55628FZ	40
A55630FZ	40
A55640FZ	40
A55656FZ	40
A55818FZ	40
A55828FZ	40
A55830FZ	40
A55840FZ	40
A55856FZ	40
A71410B	84
A71420B	84
A71430B-2PK	84
A71440B-2PK	84
A71452B	84
A71452B-CA	84
A71457B	84
A71457B-CA	84
A71458B	84
A71458B-CA	84
A72410C	83
A72420C	83
A72430C-2PK	83
A72440C-2PK	83
A72452C	83

Part No.	Pg.
A72452C-CA	83
A72457C	83
A72457C-CA	83
A72458C	83
A72458C-CA	83
A73410D	82
A73420D	82
A73430D-2PK	82
A73440D-2PK	82
A73452D	82
A73452D-CA	82
A73457D	82
A73457D-CA	82
A73458D	82
A73458D-CA	82
A86666FZ	38
AG1006FZ	43
AG1012FZ	43
AG1016FZ	43
AG1090FZ	43
AG1091FZ	43
AG1092FZ	43
AG1093FZ	43
AG1099FZ	43
AG1102FZ	42
AG1200FZKIT	42
AG1202FZ	42
AG1402FZ	42
AG1500FZKIT	42
AG1502FZ	42
AG2-10	86
AG4-10	86
AG7	86
AG934FZ	43
AL2000FZ	45
AL2025FZ-1	45
AL2025FZ-2	45
AL2050	86

Part No.	Pg.
AL2051FZ	45
AT1475FZ	48
CB20100F	12
CB20200F	12
CF10050F	12
DRAIN013	11
FDRCF1150030	11
FDRCF1150058	11
FDRCF1150115	11
FILTER057	11
FILTER107KIT	11
FILTERKIT011	11
FILTERKIT012	11
FKIT008AWB	11
FKIT011A	11
FKIT026A	11
FS050V80Y1	10
FS05V080I1	9
FS07V080Y1	10
FS10V080V1	10
FS10V120V1	10
FXS07V080V1	9
FXS07V080V3-208	9
FXS07V080V3-230	9
FXS10A120V1	9
FXS10A120V3-208	9
FXS10A120V3-230	9
FXS10V080V1	9
FXS10V080V3-208	9
FXS10V080V3-230	9
FXS10V120V1	9
FXS10V120V3-208	9
FXS10V120V3-230	9
FZ512725	65
FZ512730	65
FZ512735	65
FZ512825	65
FZ512830	65

Part No.	Pg.
FZ512835	65
FZ512930	65
FZ512935	65
FZ8120603	67
FZ8140503	66
FZ8160253	66
GCB12	95
HFZ1202YW3S	16
HFZ1202YW4S	16
HFZ1204YW3S	16
HFZ1204YW4S	16
HFZ1206YW3S	16
HFZ1206YW4S	16
HFZ1208YW3S	16
HFZ12100YW3	14
HFZ12100YW4	14
HFZ12250YW	20, 21
HFZ1225YW3	14
HFZ1250YW3	14
HFZ1250YW3-CA	14
HFZ1250YW4	14
HFZ1405YW2B	16
HFZ14100YW2	14
HFZ14100YW2-3X	14
HFZ14100YW2-CA	14
HFZ14100YW2-D	15
HFZ14250YW	20, 21
HFZ1425YW2	14
HFZ1425YW2-CA	14
HFZ1425YW2-D	15
HFZ1450YW2	14
HFZ1450YW2-CA	14
HFZ1450YW2-D	15
HFZ1450YW2-E	14
HFZ3802YW2B	16
HFZ3804YW2B	16
HFZ3806YW2B	16
HFZ38100YW2	14

Part No.	Pg.
HFZ38100YW2-CA	14
HFZ38100YW2-D	15
HFZ38100YW2-E	14
HFZ38250YW	20, 21
HFZ3825YW2	14
HFZ3825YW2-CA	14
HFZ3825YW2-D	15
HFZ3825YW2-E	14
HFZ3835YW2	14
HFZ3835YW2-D	15
HFZ3850YW2	14
HFZ3850YW2-3X	14
HFZ3850YW2-CA	14
HFZ3850YW2-D	15
HFZ3850YW2-E	14
HFZ3850YW3	14
HFZBRP1	19
HFZC505BRS-E	54
HFZC505GRS-E	54
HFZC505GYS-E	54
HFZC505TCS-E	54
HFZC5100BRS-E	54
HFZC5100GRS-E	54
HFZC5100GYS-E	54
HFZC5100TCS-E	54
HFZC510BRS-E	54
HFZC510GRS-E	54
HFZC510GYS-E	54
HFZC510TCS-E	54
HFZC525BRS-E	54
HFZC525GRS-E	54
HFZC525GYS-E	54
HFZC525TCS-E	54
HFZC550BRS	54
HFZC550BRS-E	54
HFZC550GRS	54
HFZC550GRS-E	54
HFZC550GYS	54

Part No.	Pg.
HFZC550GYS-E	54
HFZC550TCS	54
HFZC550TCS-E	54
HFZC575BRS-E	54
HFZC575GRS-E	54
HFZC575GYS-E	54
HFZC575TCS-E	54
HFZCLB11D	16
HFZCLB11D-3X	16
HFZG12050QN	55
HFZG505YW	52
HFZG505YW-E	52
HFZG505YWLI	52
HFZG505YWS	51
HFZG505YWS-E	51
HFZG5100YW	52
HFZG5100YW-36T	52
HFZG5100YW-CA	52
HFZG5100YW-E	52
HFZG5100YWS	51
HFZG5100YWS-CA	51
HFZG5100YWS-E	51
HFZG510YW	52
HFZG510YW-CA	52
HFZG510YW-E	52
HFZG510YWLI	52
HFZG510YWS	51
HFZG510YWS-CA	51
HFZG510YWS-E	51
HFZG525YW	52
HFZG525YW-E	52
HFZG525YWS	51
HFZG525YWS-CA	51
HFZG525YWS-E	51
HFZG550YW	52
HFZG550YW-48T	52
HFZG550YW-CA	52
HFZG550YW-E	52

Part No.	Pg.
HFZG550YWS	51
HFZG550YWS-30X	51
HFZG550YWS-CA	51
HFZG550YWS-E	51
HFZG575YW	52
HFZG575YW-48T	52
HFZG575YW-E	52
HFZG575YWS	51
HFZG575YWS-CA	51
HFZG575YWS-E	51
HFZG6100YW	52
HFZG6100YW-E	52
HFZG650YW	52
HFZG650YW-E	52
HFZG675YW	52
HFZG675YW-CA	52
HFZG675YW-E	52
HFZGA60	57
HFZGAK01	55
HFZGAK02	55
HFZGAK02-CA	55
HFZGAK11	56
HFZGAK12	56
HFZGAK13	56
HFZGAK14	56
HFZGSK01	57
HFZP14100YW2	22
HFZP14100YW2-D	23
HFZP1425YW2	22
HFZP1425YW2-D	23
HFZP1450YW2	22
HFZP1450YW2-D	23
HFZP3806YW2B	23
HFZP38100YW2	22
HFZP38100YW2-D	23
HFZP3825YW2	22
HFZP3825YW2-D	23
HFZP3835YW2	22

Part No.	Pg.
HFZP3850YW2	22
HFZP3850YW2-D	23
HFZPW3425M	63
HFZPW3425M-4X	63
HFZPW3425M-E	63
HFZPW3450M	63
HFZPW3450M-3X	63
HFZPW3450M-E	63
HFZPW3525M	63
HFZPW3525M-4X	63
HFZPW3525M-E	63
HFZPW3550M	63
HFZPW3550M-3X	63
HFZPW3550M-E	63
HFZPW36425M	63
HFZPW36425M-E	63
HFZPW36450M	63
HFZPW36450M-E	63
HFZPW40525M	63
HFZPW40525M-E	63
HFZPW40550M	63
HFZPW40550M-E	63
HFZPW426050Q	63
HFZPW426050Q-E	63
HFZPW426100Q	63
HFZPW426100Q-E	63
HFZW58250YW	20, 21
HFZWP5100	61
HFZWP550	61
HGH2	79
HGH2-FZ	46
HGH7-FZ	46
HR-05	20
HRE1225RD3	79
HRE1250RD3	79
HRE3825RD2	79
HRE3850RD2	79
HSF3825BL2	77

Part No.	Pg.
HSF3850BL2	77
HSFG5100GR	78
HSFG550GR	78
HSFG550GR-CA	78
HSFR3850BK2	77
HSFRV425	78
HSFRV450	78
HSFRV525	78
HSFRV550	78
HWF3825BL2	79
HWF3850BL2	79
ISOLATORS001	11
L1025	92
L1045L	89
L1075L	89
L12140	93
L1305	91
L1310	91
L1320	91
L1325	92
L1355	92
L1355FZ	70
L1380	90
L1380-B	90
L1380-C	90
L1388LFZ	69
L1388LFZ-B	69
L1388LFZ-C	69
L1700	90
L2010	93
L2010-2PK	93
L2015	93
L2020	93
L2040	93
L2050FZ	70
L2100-1	93
L2110	93
L2130	93

Part No.	Pg.
L2210-1	94
L2270-1	94
L2270SP-1	94
L2275-1	94
L2275SP-1	94
L2285SP-1	94
L2440	95
L2470	95
L2475	95
L2910FZ	71
L2925FZ	71
L2925FZSP	71
L2955FZSP	71
L2965FZSP	71
L3000	95
L5001	96
L5031	96
L5211	96
L5221	96
L5401	96
L5501	96
L5601	96
L5621	96
L5701	96
L5900	96
L5910	96
L5950	96
L5960	95
L5970	95
L5990	96
L8011FZ	30
L8011FZLI	34
L8041FZ	30
L8041FZLI	34
L8232FZ	27
L8250FZ	27
L8250FZLI	34
L8251FZP	26

Part No.	Pg.
L8251FZPLI	34
L8300-B	25, 75
L8300-W	25, 75
L8305FZ	25
L8305FZLI	34
L8305LI	75
L8306FZ	25
L8310	73, 74, 75
L8335FZ	25
L8335FZLI	34
L8335LI	75
L8340FZ	62
L8340FZLI	34
L8603FZ	28
L8611FZ	28
L8611FZLI	34
L8650FZ	31
L8651FZ	33
L8651FZLI	34
L8652FZ	32
L8654FZ	33
L8654FZLI	34
L8711FZ	29
L8741FZ	29
LP1410AFZ	17
LP1410AFZ-CA	17
LP1415AFZ	17
LP1420AFZ	17
LP1420AFZ-CA	17
LP1425AFZ	17
MAINKIT008A	11
NFZG01-N	60
NFZG02-N	60
NFZG21	58
NFZG51	58
NFZG51-E	58
NFZG52	58
NFZG52-E	58

Part No.	Pg.
NFZG61	58
NFZG61-E	58
NFZG62	58
NFZG62-CA	58
NFZG62-E	58
NFZG63	58
NFZG64	59
NFZG64-E	59
NFZG65	59
NFZG65-E	59
NFZG66	59
NFZG66-E	59
NFZG67	59
NFZG67-E	59
NFZG69	59
NFZG70	59
NFZG70-E	59
OILFZ004	11
OILPIS102Q	11
RP900250	20, 21
RP900250BS	20, 21
RP900250S	20, 21
RP900375	20, 21
RP900375BS	20, 21
RP900375S	20, 21
RP900500	20, 21
RP900500S	20, 21
RP900625F	20, 21
RP900625M	20, 21
RP901250	20, 21
RP901375	20, 21
RP901500	20, 21
SFZG61	60
SFZG61-E	60
SFZG62	60
SFZG62-E	60
TH0317	86



SEE FLEXZILLA® IN ACTION!

VIEW OUR PRODUCT VIDEOS ONLINE!

 flexzilla.com

 www.youtube.com/@Flexzilla

 legacymfg.com

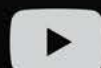
 www.youtube.com/@LegacyInnovation

Videos available upon request



Mission:

To create innovative products that customers are passionate about.

Vision:

Legacy Manufacturing creates leading global brands that consistently surpass customer expectations for performance and job satisfaction.

We challenge convention, embrace experimentation and applaud innovation. Legacy constantly seeks ways to make our products better.

Taking the work out of work.™



Legacy Manufacturing Company

6509 Partners Ave
Marion, IA 52302
phone: 319-373-7305
toll-free: 800-645-8258
email: info@flexzilla.com
legacymfg.com
flexzilla.com

See Flexzilla in Action!



Visit Legacy...



Published: January 1, 2024

Revised: January 10, 2024

Flexzilla and The Flexzilla Stylized X both are registered trademarks of Weems Industries, Inc. The color CHARTREUSE is a registered trademark of Weems Industries, Inc., including but not limited to U.S. Reg. Nos. 4,827,169 & 5,293,921.

SwivelGrip is a registered trademark of Weems Industries, Inc.

SwivelGrip® Patent Pending © Legacy Manufacturing Co.

Colors is a trademark of Weems Industries, Inc.

ColorConnex is a registered trademark of Weems Industries, Inc.

Legacy is a trademark of Weems Industries, Inc.

ColorConnex: U.S. Pat. No. 7,980,599 & 8,430,431 and Canadian Registration No. 2,575,170

Lock-n-Load: U.S. Pat. No. 8,297,476 B2 and Canadian Pat. No. 02743126

Copyright © 2024 Legacy Manufacturing Co. All Rights Reserved.