

vegó garden



PRODUCT CATALOG

We've put more thought into your garden.

Vego's modular garden beds are a fully considered system, with all the room and features to ensure you're good to grow.



100% non-toxic.

Proprietary materials means no leaching of metals & toxins for crops that stay clean.



Completely modular.

Standardized, interchangeable components to help you create your ideal garden configuration.



Super useful add-ons.

Trellises, covers, and all other upgrades to seriously level-up your garden.



Safety always in mind.

Rounded corners, smooth edges, and rounded cap nuts to protect hands, plants, and little ones.

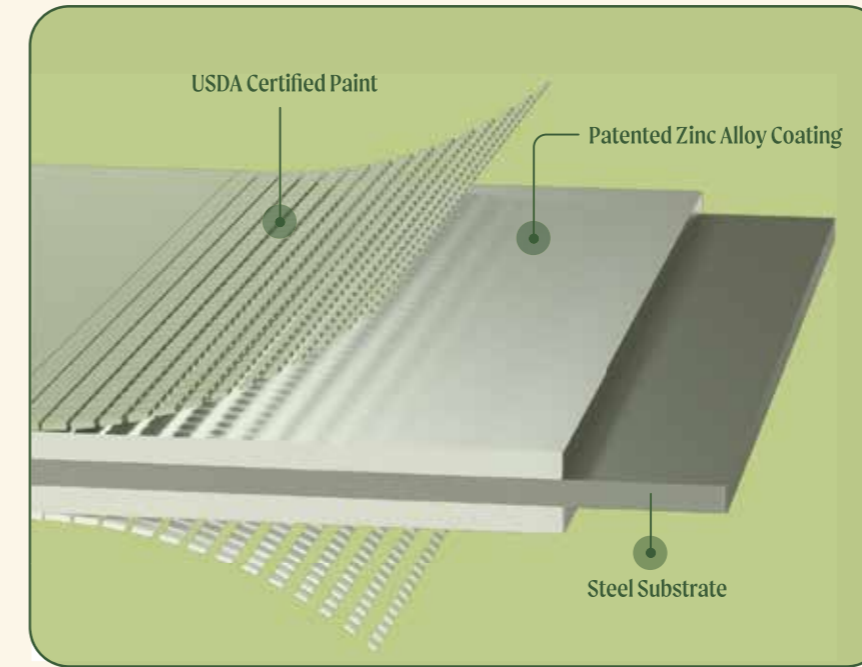

Nontoxic Garden Bed in the Industry

VZ2.0 Material:



The 1st garden bed with non-toxic USDA-approved paint



Developed by Akzo Nobel



100% Non-toxic, Eco Friendly Materials



Tested at the Texas A&M National Corrosion & Materials Reliability Lab

Easy to Assemble

5x more corrosion-resistant steel substrate, coated in Zinc, Aluminum, & Magnesium + USDA certified paint for increased longevity

Long-Lasting Quality

building your dream garden is as easy as tightening the bolts

Easy Shipping & Storage

panelized design enables easy shipping, handling and inventory storage

Table Of Content

11" Garden Beds 01

11" Tall 4 In 1	02
11" Tall 6 In 1	10
11" Tall 9 In 1	18
11" Tall 10 In 1	26
11" Tall 42" Wide Round	34
11" Tall 2' Wide Extension Kit	42

17" Garden Beds 47

17" Tall 4 In 1	48
17" Tall 6 In 1	56
17" Tall 9 In 1	64
17" Tall 10 In 1	72
17" Tall 42" Wide Round	80
17" Tall 2' Wide Extension Kit	88

32" Garden Beds 93

32" Extra Tall 4 In 1	94
32" Extra Tall 6 In 1	102

32" Extra Tall 9 In 1	110
32" Extra Tall 10 In 1	118
32" Extra Tall 42 Wide Round	126
32" Tall 2' Wide Extension Kit	134

Special Shapes 139

17" Tall L- Standard Size	140
17" Tall L- Large Size	148
17" Tall U- Standard Size	156
17" Tall U- Large Size	164
17" Tall U- Jumbo Size	172
Cascading Metal Raised Garden Bed Kit	180

Small Shapes & Parts 189

Tree Surround & Watering Ring Kit	190
17" Tall Kids First Garden Bed 42" x 24"	194
17" Tall Herb Garden Bed 24" Wide	202
17" Tall Berry Garden Bed 30" Wide	206
Bracing Rods - Twin Pack	210

Advanced Beds 213

Self-Watering Garden Bed	214
Self-Watering Planter - Twin Pack	218
Elevated Rolling Garden Bed	222
Dragon Fruit Rolling Planter	226
Rolling Planter - Twin Pack	234

Add Ons 243

Solar Garden Light	244
Garden Tool Box	246
Cover System & Mister Irrigation	248
Arched Trellis System	250
Wall Trellis System	252
In-Ground Worm Composter	254
Wicking Cells	256
Stainless Steel Gopher Net	258

Seeding Trays 261

Standard Seedling Trays	262
Seed Starting Bundle - 10 in. x 10 in.	264

Seed Starting Bundle - 10 in. x 20 in.	266
Jumbo Seedling Trays	268
Seedling Tray Lids with Drip Irrigation	270
Bottom Watering Trays	272

Essentials 275

Organic Slow Release Fertilizer	276
Straw Mulch	278
10 in 1 Hori Hori Knife Kit	280
Modular Garden Sifter	282
Vego Salad Serving Bowl	284
Vego Coffee Mug- Pearl White	292
Vego Garden Bag	300
Texas Gardener Magazine Planning Guide 2023	302
Locally Sourced Organic Worm Castings	304
Vego Sticker Kit	306
Vego Garden eGift Card	307



11" Garden Beds



Model No.
VB4N111W



11" Tall 4 In 1-Pearl White Modular Metal Raised Garden Bed Kit

Vego Garden's 11" Tall 4 In 1 metal garden raised bed is designed for urban gardening with its optimized size for a small-medium backyard.

MSRP: \$119.95



Product Features

- 4
DIFFERENT
CONFIGURATIONS
- 11
INCHES
TALL
- 20+
YEARS
DESIGN LIFE
- 20
MINUTES TO
ASSEMBLE
- 100%
RECYCLABLE
METAL

Configurations

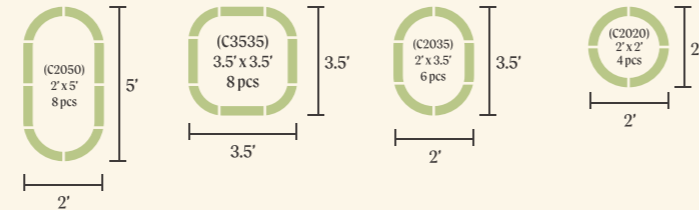



Model No.
VB4N111G



11" Tall 4 In 1-Olive Green Modular Metal Raised Garden Bed Kit

Vego Garden's 11" Tall 4 In 1 metal garden raised bed is designed for urban gardening with its optimized size for a small-medium backyard.

MSRP: \$119.95



Product Features

- 4 DIFFERENT CONFIGURATIONS
- 11 INCHES TALL
- 20+ YEARS DESIGN LIFE
- 20 MINUTES TO ASSEMBLE
- 100% RECYCLABLE METAL

Configurations

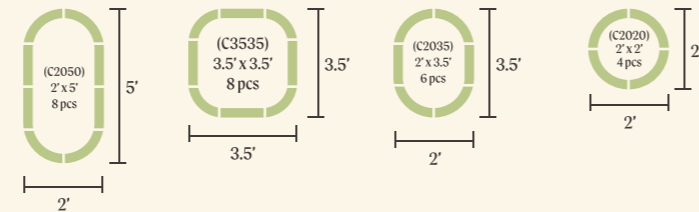



Model No.
VB4N111BG



11" Tall 4 In 1-British Green Modular Metal Raised Garden Bed Kit

Vego Garden's 11" Tall 4 In 1 metal garden raised bed is designed for urban gardening with its optimized size for a small-medium backyard.

MSRP: \$119.95



Product Features

- 4 DIFFERENT CONFIGURATIONS
- 11 INCHES TALL
- 20+ YEARS DESIGN LIFE
- 20 MINUTES TO ASSEMBLE
- 100% RECYCLABLE METAL

Configurations

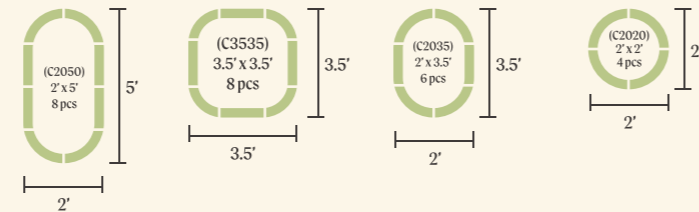



11" Tall 4 In 1-Modern Gray Modular Metal Raised Garden Bed Kit

Vego Garden's 11" Tall 4 In 1 metal garden raised bed is designed for urban gardening with its optimized size for a small-medium backyard.

MSRP: \$119.95



Model No.
VB4N111MG

Product Features

- 4
DIFFERENT
CONFIGURATIONS
- 11
INCHES
TALL
- 20+
YEARS
DESIGN LIFE
- 20
MINUTES TO
ASSEMBLE
- 100%
RECYCLABLE
METAL

Configurations

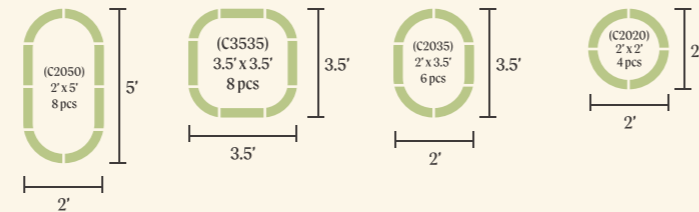



Model No.
VB6N111W



11" Tall 6 In 1-Pearl White Modular Metal Raised Garden Bed Kit

Vego Garden's 11" Tall 6-In-1 metal garden raised bed is designed for urban gardening with an optimized size and cost-conscious height for a small to medium backyards.

MSRP: \$139.95



Product Features

- 6
DIFFERENT
CONFIGURATIONS
- 11
INCHES
TALL
- 20+
YEARS
DESIGN LIFE
- 25
MINUTES TO
ASSEMBLE
- 100%
RECYCLABLE
METAL

Configurations

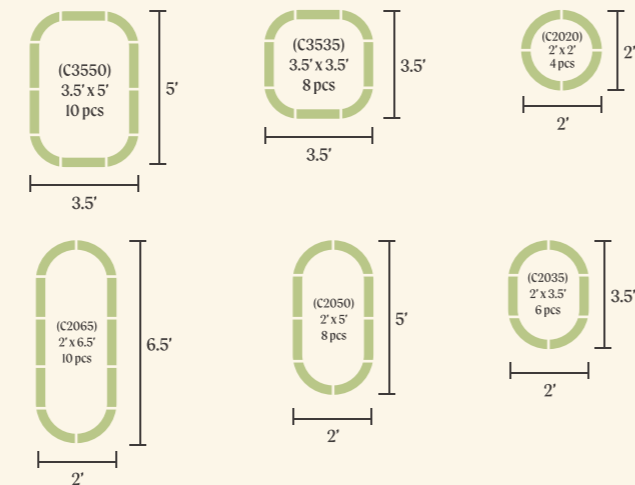



Model No.
VB6N111G

11" Tall 6 In 1-Olive Green Modular Metal Raised Garden Bed Kit

Vego Garden's 11" Tall 6-In-1 metal garden raised bed is designed for urban gardening with an optimized size and cost-conscious height for a small to medium backyards.

MSRP: \$139.95



Product Features

- 6
DIFFERENT
CONFIGURATIONS
- 11
INCHES
TALL
- 20+
YEARS
DESIGN LIFE
- 25
MINUTES TO
ASSEMBLE
- 100%
RECYCLABLE
METAL

Configurations

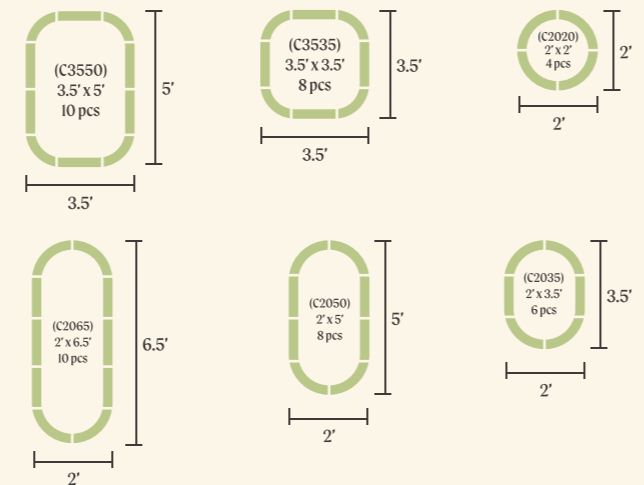

11" Tall 6 In 1-British Green Modular Metal Raised Garden Bed Kit

Vego Garden's 11" Tall 6-In-1 metal garden raised bed is designed for urban gardening with an optimized size and cost-conscious height for a small to medium backyards.

MSRP: \$139.95



Product Features

- 6
DIFFERENT
CONFIGURATIONS
- 11
INCHES
TALL
- 20+
YEARS
DESIGN LIFE
- 25
MINUTES TO
ASSEMBLE
- 100%
RECYCLABLE
METAL

Configurations

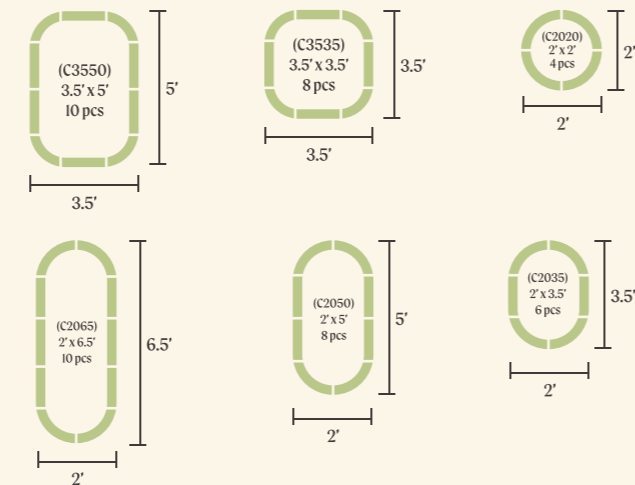

Model No.
VB6N111BG





Model No.
VB6N111MG

11" Tall 6 In 1-Modern Gray Modular Metal Raised Garden Bed Kit

Vego Garden's 11" Tall 6-In-1 metal garden raised bed is designed for urban gardening with an optimized size and cost-conscious height for a small to medium backyards.

MSRP: \$139.95



Product Features

- 6
DIFFERENT
CONFIGURATIONS
- 11
INCHES
TALL
- 20+
YEARS
DESIGN LIFE
- 25
MINUTES TO
ASSEMBLE
- 100%
RECYCLABLE
METAL

Configurations

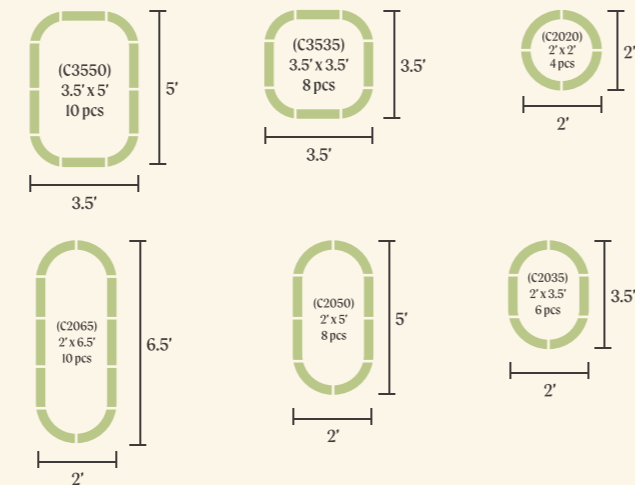



Model No.
VB9N111W



11" Tall 9 In 1-Pearl White Modular Metal Raised Garden Bed Kit

Our classic garden bed kit, in a new cost-conscious height. The 3.5' x 6.5' and 2' x 8' configurations are among the most iconic designs for anyone who is new to garden beds. Great for growing herbs, succulents, veggies, or flowers.

MSRP: \$159.95



Product Features

- 9
DIFFERENT
CONFIGURATIONS
- 11
INCHES
TALL
- 20+
YEARS
DESIGN LIFE
- 30
MINUTES TO
ASSEMBLE
- 100%
RECYCLABLE
METAL

Configurations

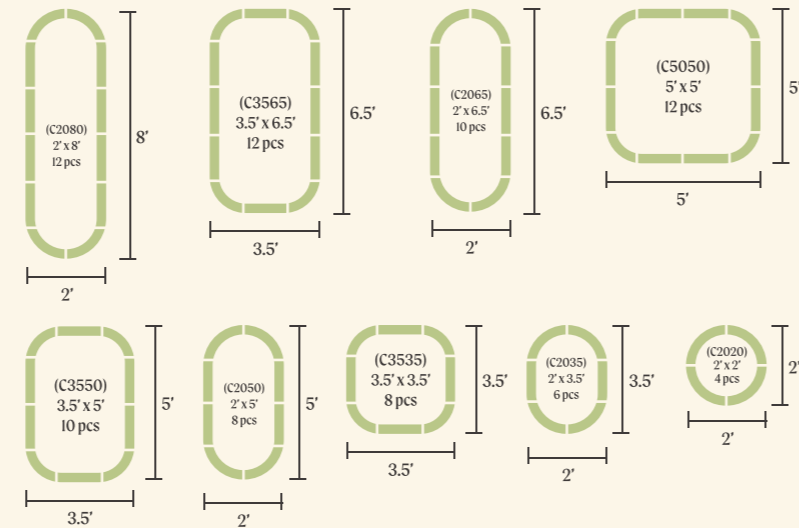



Model No.
VB9N111G



11" Tall 9 In 1-Olive Green Modular Metal Raised Garden Bed Kit

Our classic garden bed kit, in a new cost-conscious height. The 3.5' x 6.5' and 2' x 8' configurations are among the most iconic designs for anyone who is new to garden beds. Great for growing herbs, succulents, veggies, or flowers.

MSRP: \$159.95



Product Features

- 9
DIFFERENT
CONFIGURATIONS
- 11
INCHES
TALL
- 20+
YEARS
DESIGN LIFE
- 30
MINUTES TO
ASSEMBLE
- 100%
RECYCLABLE
METAL

Configurations

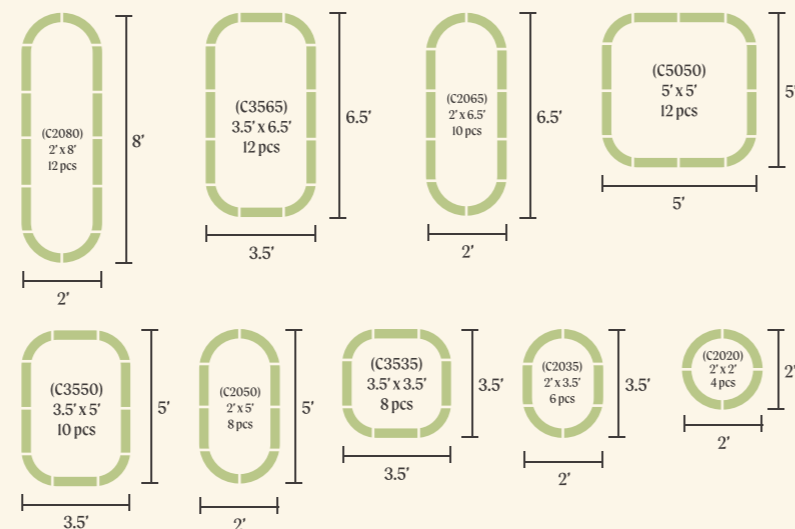

11" Tall 9 In 1-British Green Modular Metal Raised Garden Bed Kit

Our classic garden bed kit, in a new cost-conscious height. The 3.5' x 6.5' and 2' x 8' configurations are among the most iconic designs for anyone who is new to garden beds. Great for growing herbs, succulents, veggies, or flowers.

MSRP: \$159.95



Product Features

- 9
DIFFERENT
CONFIGURATIONS
- 11
INCHES
TALL
- 20+
YEARS
DESIGN LIFE
- 30
MINUTES TO
ASSEMBLE
- 100%
RECYCLABLE
METAL

Configurations

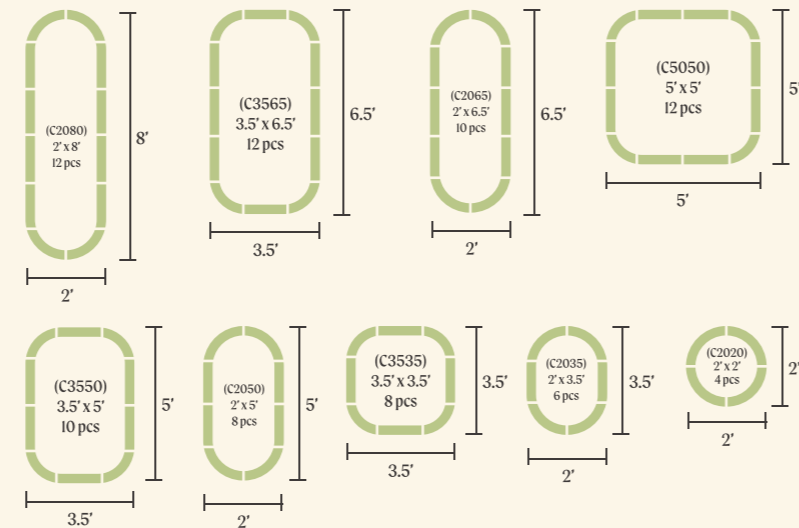

Model No.
VB9N111BG



11" Tall 9 In 1-Modern Gray Modular Metal Raised Garden Bed Kit

Our classic garden bed kit, in a new cost-conscious height. The 3.5' x 6.5' and 2' x 8' configurations are among the most iconic designs for anyone who is new to garden beds. Great for growing herbs, succulents, veggies, or flowers.

MSRP: \$159.95



Product Features

- 9
DIFFERENT
CONFIGURATIONS
- 11
INCHES
TALL
- 20+
YEARS
DESIGN LIFE
- 30
MINUTES TO
ASSEMBLE
- 100%
RECYCLABLE
METAL

Configurations

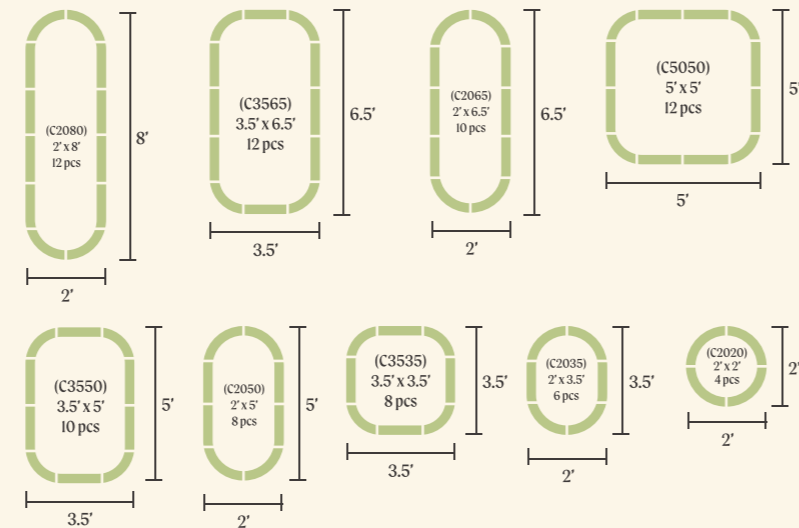

Model No.
VB9N111MG





Model No.
VB10N111W



11" Tall 10 In 1-Pearl White Modular Metal Raised Garden Bed Kit

This kit offers a spacious growing area with 10 configuration options including 4' x 8', 2.5' x 9.5', or 8 other options all in a cost-conscious 11" height. You can choose which configuration of the 10 possible designs best fits your space and maximizes your garden.

MSRP: \$219.95



Product Features

- 10
DIFFERENT
CONFIGURATIONS
- 11
INCHES
TALL
- 20+
YEARS
DESIGN LIFE
- 35
MINUTES TO
ASSEMBLE
- 100%
RECYCLABLE
METAL

Configurations

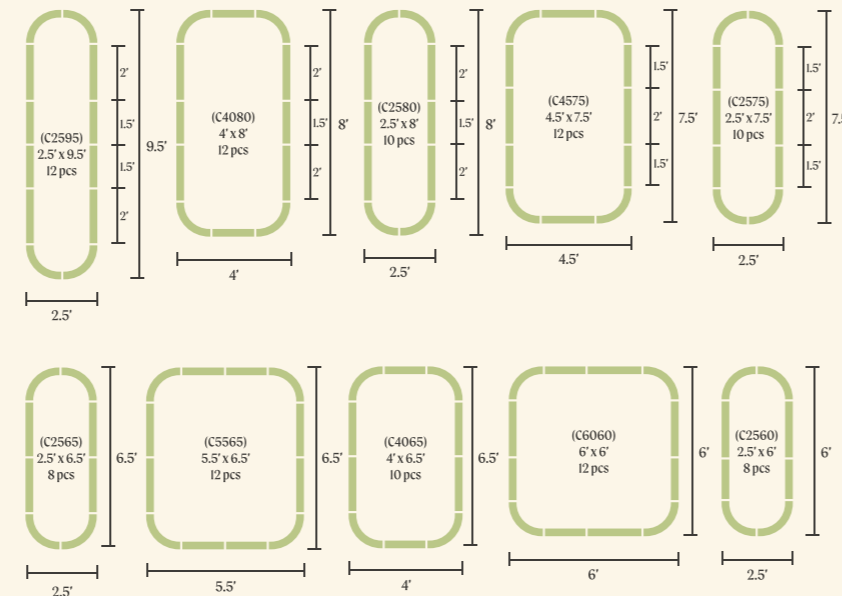



Model No.
VB10N111G



11" Tall 10 In 1-Olive Green Modular Metal Raised Garden Bed Kit

This kit offers a spacious growing area with 10 configuration options including 4' x 8', 2.5' x 9.5', or 8 other options all in a cost-conscious 11" height. You can choose which configuration of the 10 possible designs best fits your space and maximizes your garden.

MSRP: \$219.95



Product Features

- 10
DIFFERENT
CONFIGURATIONS
- 11
INCHES
TALL
- 20+
YEARS
DESIGN LIFE
- 35
MINUTES TO
ASSEMBLE
- 100%
RECYCLABLE
METAL

Configurations

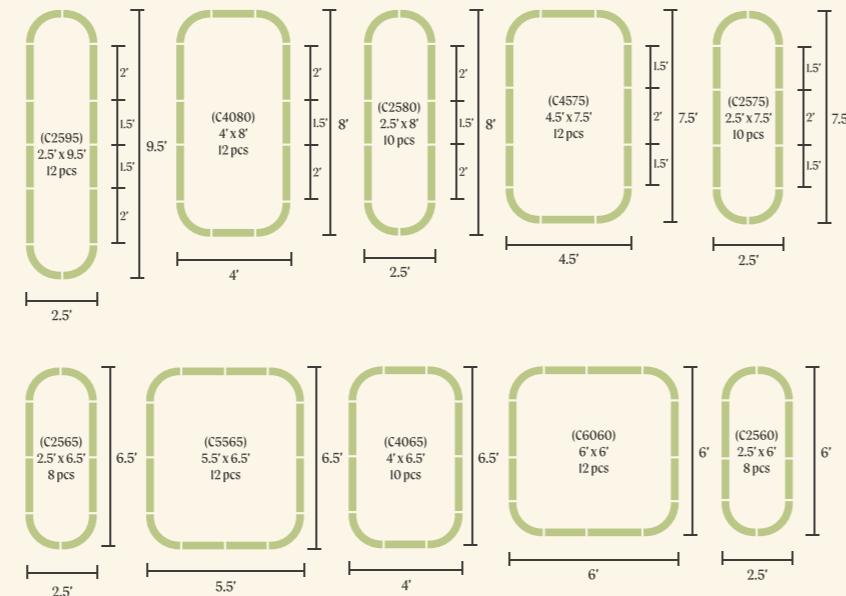



Model No.
VB10N111BG



11" Tall 10 In 1-British Green Modular Metal Raised Garden Bed Kit

This kit offers a spacious growing area with 10 configuration options including 4' x 8', 2.5' x 9.5', or 8 other options all in a cost-conscious 11" height. You can choose which configuration of the 10 possible designs best fits your space and maximizes your garden.

MSRP: \$219.95



Product Features

- 10
DIFFERENT
CONFIGURATIONS
- 11
INCHES
TALL
- 20+
YEARS
DESIGN LIFE
- 35
MINUTES TO
ASSEMBLE
- 100%
RECYCLABLE
METAL

Configurations

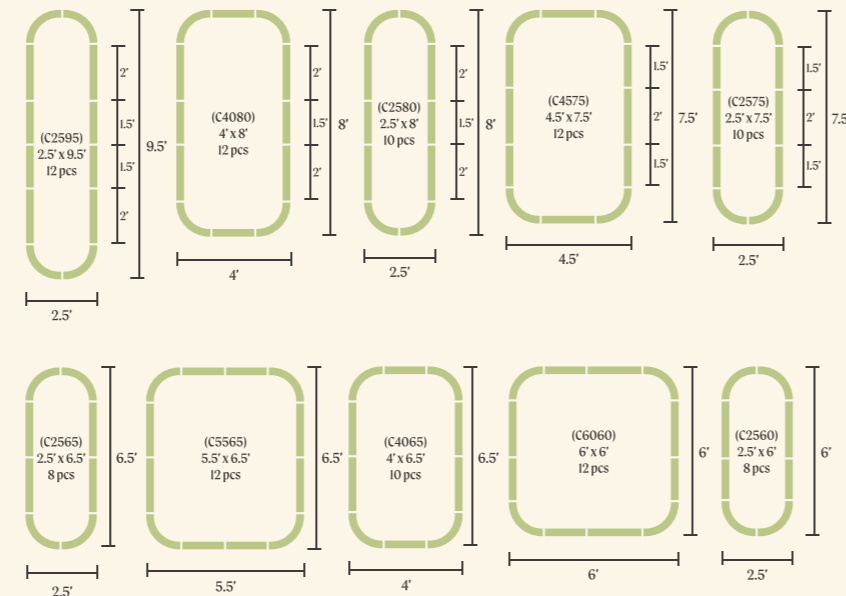



Model No.
VB10N111MG



11" Tall 10 In 1-Modern Gray Modular Metal Raised Garden Bed Kit

This kit offers a spacious growing area with 10 configuration options including 4' x 8', 2.5' x 9.5', or 8 other options all in a cost-conscious 11" height. You can choose which configuration of the 10 possible designs best fits your space and maximizes your garden.

MSRP: \$219.95



Product Features

- 10
DIFFERENT
CONFIGURATIONS
- 11
INCHES
TALL
- 20+
YEARS
DESIGN LIFE
- 35
MINUTES TO
ASSEMBLE
- 100%
RECYCLABLE
METAL

Configurations

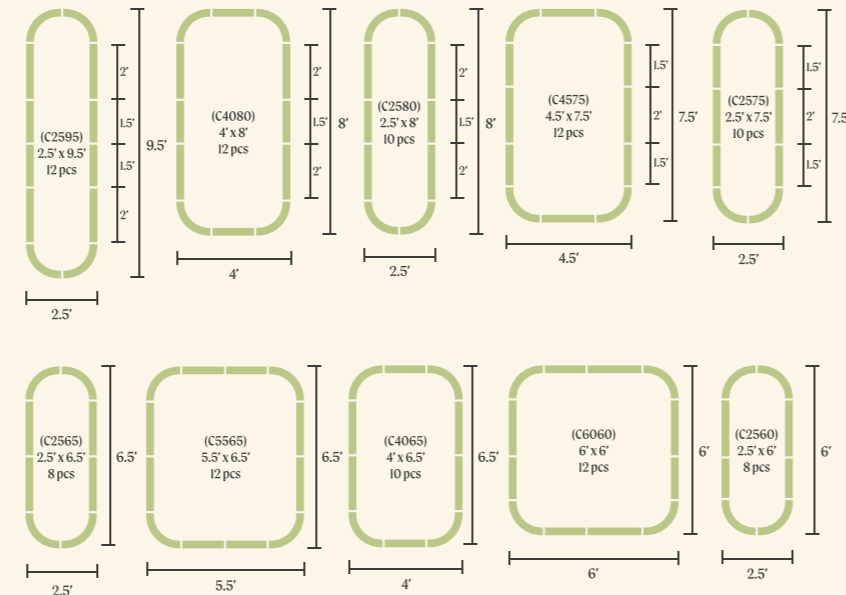

11" Tall 42" Wide Round-Pearl White Metal Raised Garden Bed Kit

The 42" round bed is an ideal size for small veggie patches. The round shape makes it super easy to plant seeds or plant starts, and the cost-conscious height still leaves plenty of root depth for veggies like lettuce, herbs, squash, & more!

MSRP: \$99.95



Product Features

11 INCHES TALL	20+ YEARS DESIGN LIFE	20 MINUTES TO ASSEMBLE	100% RECYCLABLE METAL
----------------------	-----------------------------	------------------------------	-----------------------------

Configurations



Round
Diameter(in): 42"
Height(in): 11"
Thickness: 0.6mm
Volume: 13.6cu ft



Model No.
VRB4211W



11" Tall 42" Wide Round-Olive Green Metal Raised Garden Bed Kit

The 42" round bed is an ideal size for small veggie patches. The round shape makes it super easy to plant seeds or plant starts, and the cost-conscious height still leaves plenty of root depth for veggies like lettuce, herbs, squash, & more!

MSRP: \$99.95



Product Features

11 INCHES TALL		20+ YEARS DESIGN LIFE		20 MINUTES TO ASSEMBLE		100% RECYCLABLE METAL
----------------------	--	-----------------------------	--	------------------------------	--	-----------------------------

Configurations



42"

Round
Diameter(in): 42"
Height(in): 11"
Thickness: 0.6mm
Volume: 13.6cu ft



Model No.
VRB4211G



11" Tall 42" Wide Round-British Green Metal Raised Garden Bed Kit

The 42" round bed is an ideal size for small veggie patches. The round shape makes it super easy to plant seeds or plant starts, and the cost-conscious height still leaves plenty of root depth for veggies like lettuce, herbs, squash, & more!

MSRP: \$99.95



Product Features

11 INCHES TALL	20+ YEARS DESIGN LIFE	20 MINUTES TO ASSEMBLE	100% RECYCLABLE METAL
----------------------	-----------------------------	------------------------------	-----------------------------

Configurations



Round
Diameter(in): 42"
Height(in): 11"
Thickness: 0.6mm
Volume: 13.6cu ft



Model No.
VRB4211BG



11" Tall 42" Wide Round-Modern Gray Metal Raised Garden Bed Kit

The 42" round bed is an ideal size for small veggie patches. The round shape makes it super easy to plant seeds or plant starts, and the cost-conscious height still leaves plenty of root depth for veggies like lettuce, herbs, squash, & more!

MSRP: \$99.95



Product Features

11 INCHES TALL		20+ YEARS DESIGN LIFE		20 MINUTES TO ASSEMBLE		100% RECYCLABLE METAL
----------------------	--	-----------------------------	--	------------------------------	--	-----------------------------

Configurations



Round
Diameter(in): 42"
Height(in): 11"
Thickness: 0.6mm
Volume: 13.6cu ft



Model No.
VRB4211MG

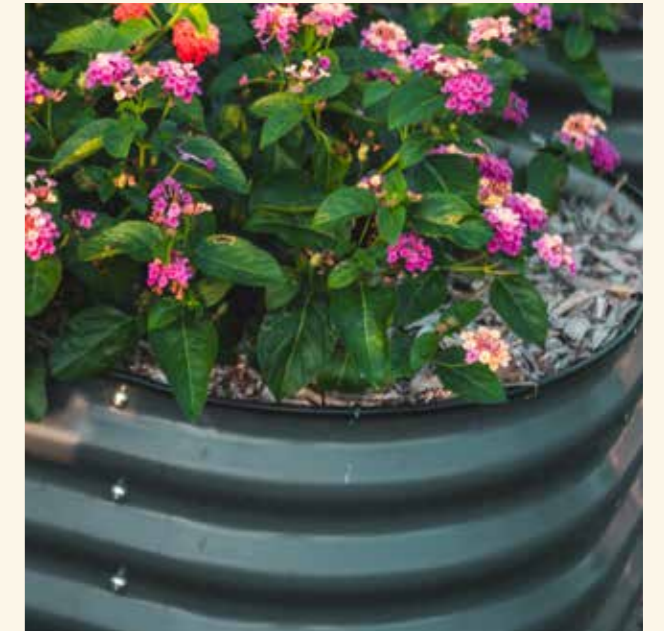

11" Tall 2' Wide Extension Kit-Pearl White

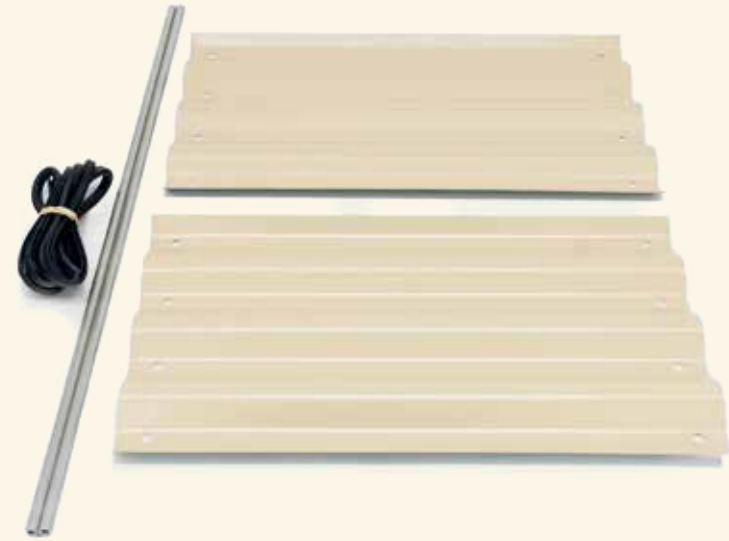

Model No	Rod Width
VE11W-BR25	2.5'
VE11W-BR35	3.5'
VE11W-BR40	4.0'
VE11W-BR45	4.5'



Configurations

- 2 ft. Extension Kit Includes:**
- 2 X Straight Panel (Each 2.0 ft. wide)
 - 2 X Bracing Rod (Select the width)
 - Hardware, Edging Cover

This kit will extend the length of your garden bed by 2 ft. With One Extension Kit. You can expand your 4 x 8 ft. bed into 4 x 10 ft., or 2.5 x 9.5 ft. into 2.5 x 11.5 ft. With Two extension kits, you can get a garden bed measuring 2.5 x 13.5 ft or 4 x 12 ft. It is just that simple.

11" Tall 2' Wide Extension Kit-Olive Green

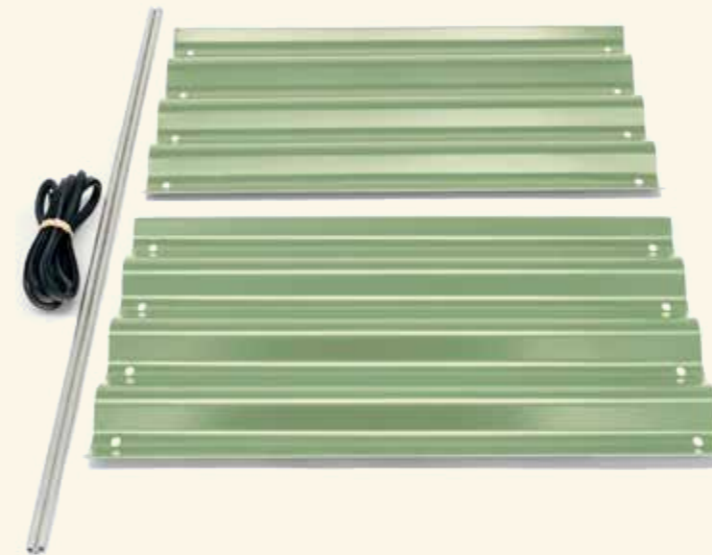

Model No	Rod Width
VE11G-BR25	2.5'
VE11G-BR35	3.5'
VE11G-BR40	4.0'
VE11G-BR45	4.5'



Configurations

- 2 ft. Extension Kit Includes:**
- 2 X Straight Panel (Each 2.0 ft. wide)
 - 2 X Bracing Rod (Select the width)
 - Hardware, Edging Cover

This kit will extend the length of your garden bed by 2 ft. With One Extension Kit. You can expand your 4 x 8 ft. bed into 4 x 10 ft., or 2.5 x 9.5 ft. into 2.5 x 11.5 ft. With Two extension kits, you can get a garden bed measuring 2.5 x 13.5 ft or 4 x 12 ft. It is just that simple.

11" Tall 2' Wide Extension Kit-British Green



Model No	Rod Width
VE11BG-BR25	2.5'
VE11BG-BR35	3.5'
VE11BG-BR40	4.0'
VE11BG-BR45	4.5'



Configurations

2 ft. Extension Kit Includes:

- 2 X Straight Panel (Each 2.0 ft. wide)
- 2 X Bracing Rod (Select the width)
- Hardware, Edging Cover

This kit will extend the length of your garden bed by 2 ft. With One Extension Kit. You can expand your 4 x 8 ft. bed into 4 x 10 ft., or 2.5 x 9.5 ft. into 2.5 x 11.5 ft. With Two extension kits, you can get a garden bed measuring 2.5 x 13.5 ft or 4 x 12 ft. It is just that simple.

11" Tall 2' Wide Extension Kit-Modern Gray



Model No	Rod Width
VE11MG-BR25	2.5'
VE11MG-BR35	3.5'
VE11MG-BR40	4.0'
VE11MG-BR45	4.5'



Configurations

2 ft. Extension Kit Includes:

- 2 X Straight Panel (Each 2.0 ft. wide)
- 2 X Bracing Rod (Select the width)
- Hardware, Edging Cover

This kit will extend the length of your garden bed by 2 ft. With One Extension Kit. You can expand your 4 x 8 ft. bed into 4 x 10 ft., or 2.5 x 9.5 ft. into 2.5 x 11.5 ft. With Two extension kits, you can get a garden bed measuring 2.5 x 13.5 ft or 4 x 12 ft. It is just that simple.



17" Garden Beds



Model No.
VB4N117W



17" Tall 4 In 1-Pearl White Modular Metal Raised Garden Bed Kit

Vego Garden's 17" Tall 4 In 1 metal garden raised bed is designed for urban gardening with its optimized size for a small-medium backyard.

MSRP: \$149.95



Product Features

- 4
DIFFERENT
CONFIGURATIONS
- 17
INCHES
TALL
- 20+
YEARS
DESIGN LIFE
- 30
MINUTES TO
ASSEMBLE
- 100%
RECYCLABLE
METAL

Configurations

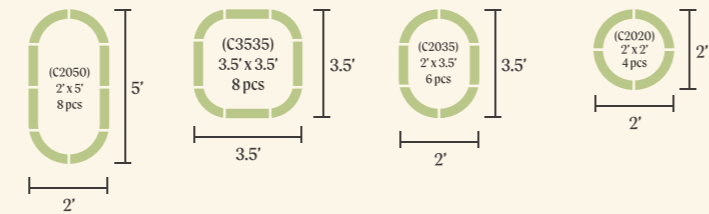



Model No.
VB4N117G



17" Tall 4 In 1-Olive Green Modular Metal Raised Garden Bed Kit

Vego Garden's 17" Tall 4 In 1 metal garden raised bed is designed for urban gardening with its optimized size for a small-medium backyard.

MSRP: \$149.95



Product Features

- 4
DIFFERENT
CONFIGURATIONS
- 17
INCHES
TALL
- 20+
YEARS
DESIGN LIFE
- 30
MINUTES TO
ASSEMBLE
- 100%
RECYCLABLE
METAL

Configurations

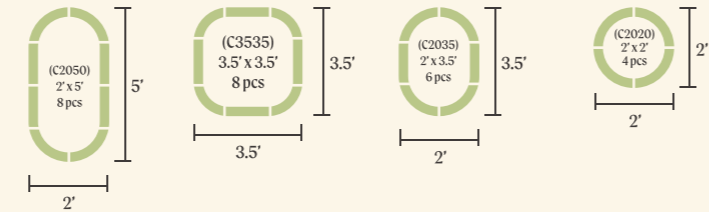



Model No.
VB4N117BW



17" Tall 4 In 1-British Green Modular Metal Raised Garden Bed Kit

Vego Garden's 17" Tall 4 In 1 metal garden raised bed is designed for urban gardening with its optimized size for a small-medium backyard.

MSRP: \$149.95



Product Features

- 4
DIFFERENT
CONFIGURATIONS
- 17
INCHES
TALL
- 20+
YEARS
DESIGN LIFE
- 30
MINUTES TO
ASSEMBLE
- 100%
RECYCLABLE
METAL

Configurations

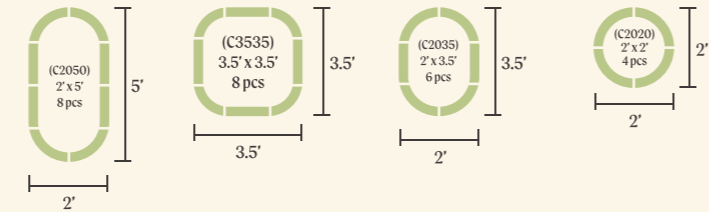



Model No.
VB4N117MG



17" Tall 4 In 1-Modern Gray Modular Metal Raised Garden Bed Kit

Vego Garden's 17" Tall 4 In 1 metal garden raised bed is designed for urban gardening with its optimized size for a small-medium backyard.

MSRP: \$149.95



Product Features

- 4
DIFFERENT
CONFIGURATIONS
- 17
INCHES
TALL
- 20+
YEARS
DESIGN LIFE
- 30
MINUTES TO
ASSEMBLE
- 100%
RECYCLABLE
METAL

Configurations

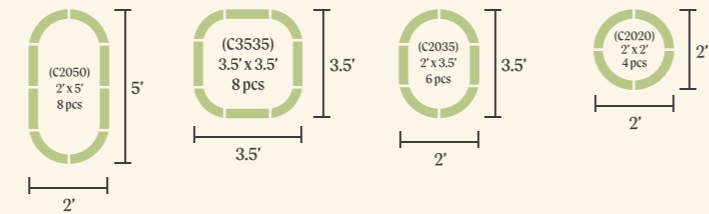



Model No.
VB6N117W



17" Tall 6 In 1-Pearl White Modular Metal Raised Garden Bed Kit

Vego Garden 17" Tall 6 In 1 metal garden raised bed is designed for urban gardening with its optimized size for a small-medium backyard.

MSRP: \$169.95



Product Features

- 6
DIFFERENT
CONFIGURATIONS
- 17
INCHES
TALL
- 20+
YEARS
DESIGN LIFE
- 35
MINUTES TO
ASSEMBLE
- 100%
RECYCLABLE
METAL

Configurations

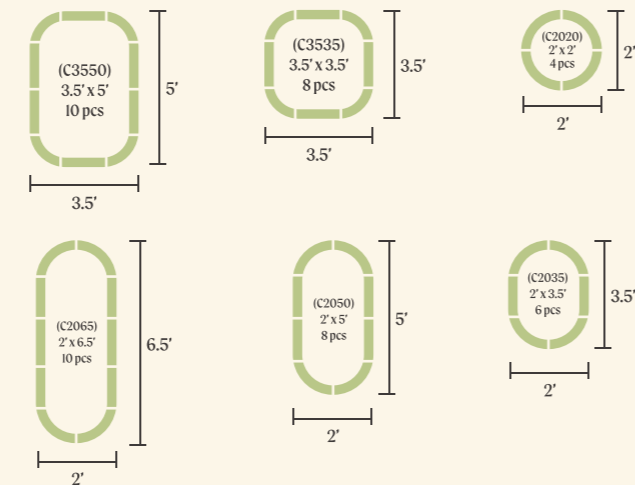



Model No.
VB6N117G



17" Tall 6 In 1-Olive Green Modular Metal Raised Garden Bed Kit

Vego Garden 17" Tall 6 In 1 metal garden raised bed is designed for urban gardening with its optimized size for a small-medium backyard.

MSRP: \$169.95



Product Features

- 6
DIFFERENT
CONFIGURATIONS
- 17
INCHES
TALL
- 20+
YEARS
DESIGN LIFE
- 35
MINUTES TO
ASSEMBLE
- 100%
RECYCLABLE
METAL

Configurations

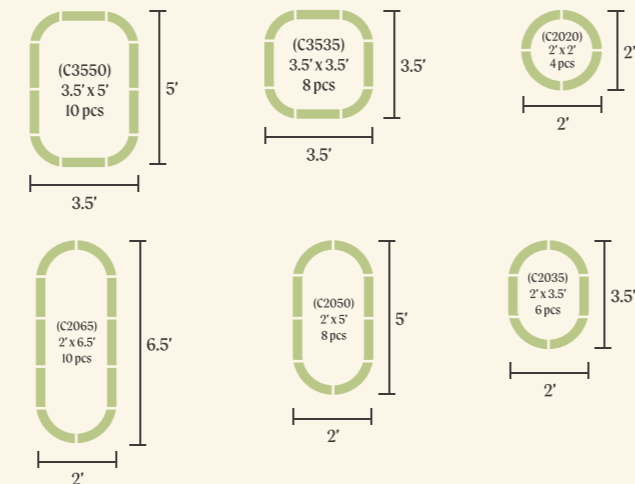



Model No.
VB6N117BG



17" Tall 6 In 1-British Green Modular Metal Raised Garden Bed Kit

Vego Garden 17" Tall 6 In 1 metal garden raised bed is designed for urban gardening with its optimized size for a small-medium backyard.

MSRP: \$169.95



Product Features

- 6
DIFFERENT
CONFIGURATIONS
- 17
INCHES
TALL
- 20+
YEARS
DESIGN LIFE
- 35
MINUTES TO
ASSEMBLE
- 100%
RECYCLABLE
METAL

Configurations

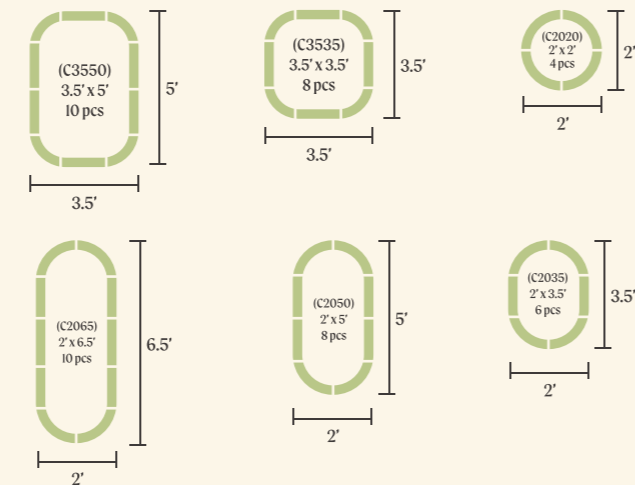



Model No.
VB6N117MG



17" Tall 6 In 1-Modern Gray Modular Metal Raised Garden Bed Kit

Vego Garden 17" Tall 6 In 1 metal garden raised bed is designed for urban gardening with its optimized size for a small-medium backyard.

MSRP: \$169.95



Product Features

- 6
DIFFERENT
CONFIGURATIONS
- 17
INCHES
TALL
- 20+
YEARS
DESIGN LIFE
- 35
MINUTES TO
ASSEMBLE
- 100%
RECYCLABLE
METAL

Configurations

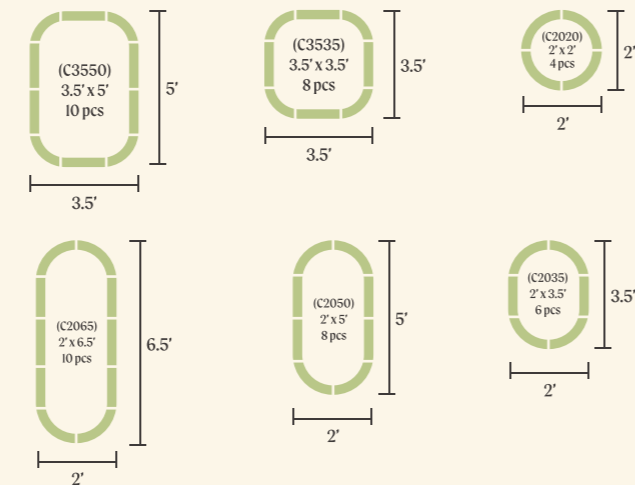



Model No.
VB9N117W



17" Tall 9 In 1-Pearl White Modular Metal Raised Garden Bed Kit

The classic of the classics, this is the first raised garden bed kit we launched. The 3.5' x 6.5' and 2' x 8' configurations are among the most iconic designs for anyone who is new to garden beds. The height is also great for easy, quick access when gardening and assists in keeping slugs and pests at a minimum too. Great for growing herbs, succulents, veggies, or flowers.

MSRP: \$189.95



Product Features

- 9
DIFFERENT
CONFIGURATIONS
- 17
INCHES
TALL
- 20+
YEARS
DESIGN LIFE
- 45
MINUTES TO
ASSEMBLE
- 100%
RECYCLABLE
METAL

Configurations

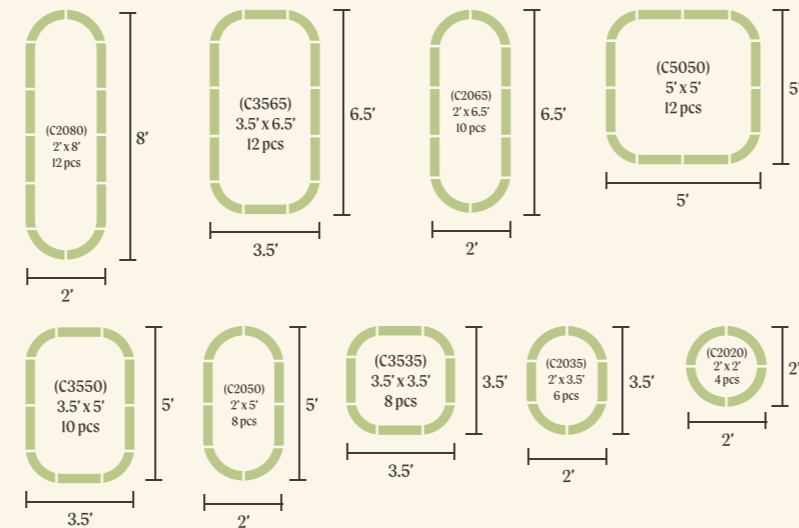



Model No.
VB9N117G



17" Tall 9 In 1-Olive Green Modular Metal Raised Garden Bed Kit

The classic of the classics, this is the first raised garden bed kit we launched. The 3.5' x 6.5' and 2' x 8' configurations are among the most iconic designs for anyone who is new to garden beds. The height is also great for easy, quick access when gardening and assists in keeping slugs and pests at a minimum too. Great for growing herbs, succulents, veggies, or flowers.

MSRP: \$189.95



Product Features

- 9
DIFFERENT
CONFIGURATIONS
- 17
INCHES
TALL
- 20+
YEARS
DESIGN LIFE
- 45
MINUTES TO
ASSEMBLE
- 100%
RECYCLABLE
METAL

Configurations

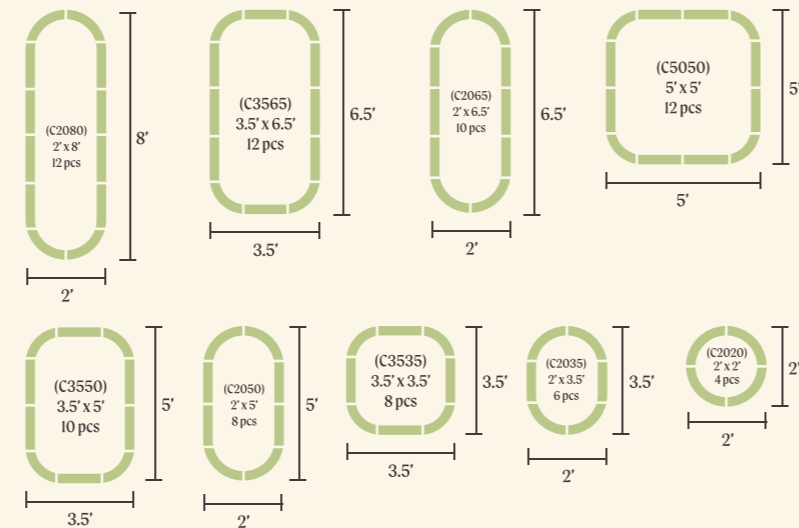



Model No.
VB9N117BW



17" Tall 9 In 1-British Green Modular Metal Raised Garden Bed Kit

The classic of the classics, this is the first raised garden bed kit we launched. The 3.5' x 6.5' and 2' x 8' configurations are among the most iconic designs for anyone who is new to garden beds. The height is also great for easy, quick access when gardening and assists in keeping slugs and pests at a minimum too. Great for growing herbs, succulents, veggies, or flowers.

MSRP: \$189.95



Product Features

- 9
DIFFERENT
CONFIGURATIONS
- 17
INCHES
TALL
- 20+
YEARS
DESIGN LIFE
- 45
MINUTES TO
ASSEMBLE
- 100%
RECYCLABLE
METAL

Configurations

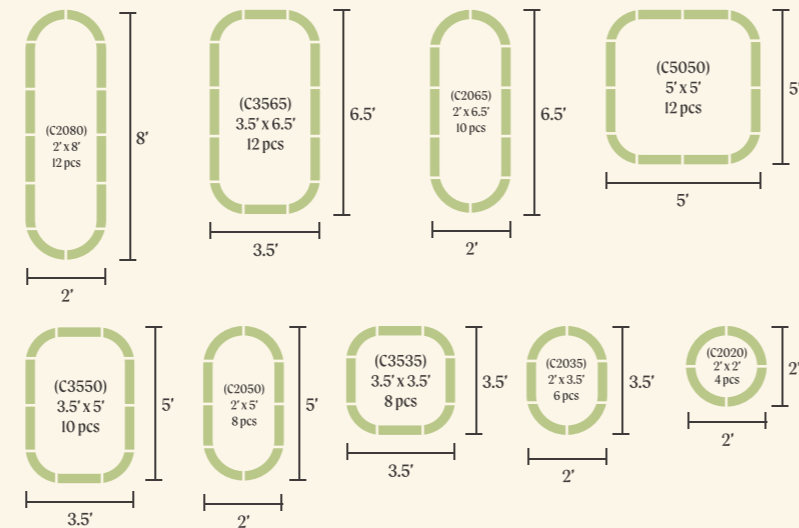



Model No.
VB9N117MG



17" Tall 9 In 1-Modern Gray Modular Metal Raised Garden Bed Kit

The classic of the classics, this is the first raised garden bed kit we launched. The 3.5' x 6.5' and 2' x 8' configurations are among the most iconic designs for anyone who is new to garden beds. The height is also great for easy, quick access when gardening and assists in keeping slugs and pests at a minimum too. Great for growing herbs, succulents, veggies, or flowers.

MSRP: \$189.95



Product Features

- 9
DIFFERENT
CONFIGURATIONS
- 17
INCHES
TALL
- 20+
YEARS
DESIGN LIFE
- 45
MINUTES TO
ASSEMBLE
- 100%
RECYCLABLE
METAL

Configurations

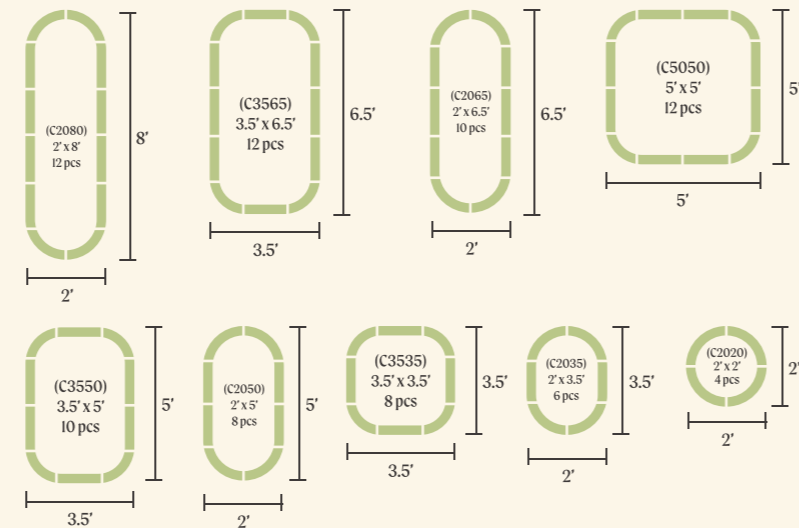



Model No.
VB10N117W



17" Tall 10 In 1-Pearl White Modular Metal Raised Garden Bed Kit

10-in-1 is the Texas-sized garden bed! This kit offers a spacious growing area with configurations including 4' x 8', 2.5' x 9.5", 6' x 6' or 7 other options. You can choose which configuration of the 10 possible designs best fits your space and maximizes your garden.

MSRP: \$259.95



Product Features

- 10
DIFFERENT
CONFIGURATIONS
- 17
INCHES
TALL
- 20+
YEARS
DESIGN LIFE
- 50
MINUTES TO
ASSEMBLE
- 100%
RECYCLABLE
METAL

Configurations

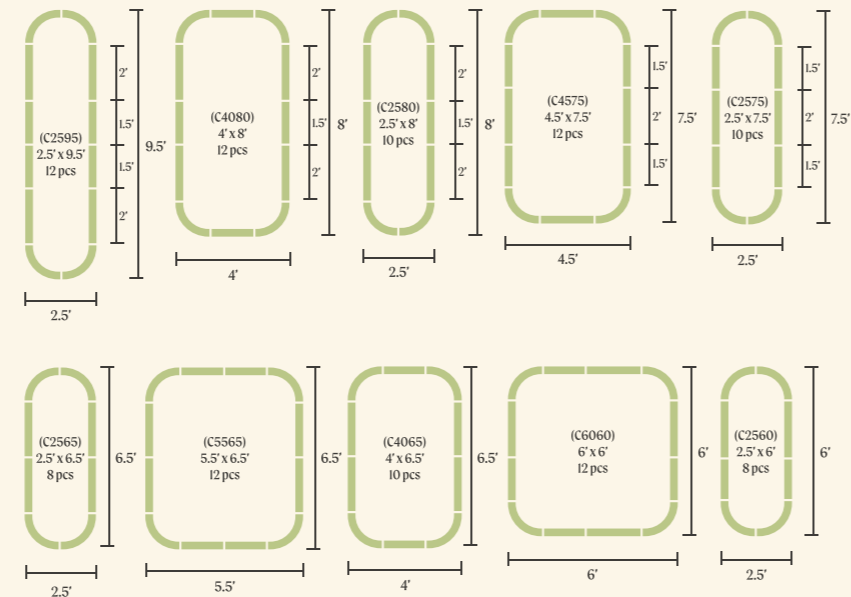



Model No.
VB10N117G



17" Tall 10 In 1-Olive Green Modular Metal Raised Garden Bed Kit

10-in-1 is the Texas-sized garden bed! This kit offers a spacious growing area with configurations including 4' x 8', 2.5' x 9.5', 6' x 6' or 7 other options. You can choose which configuration of the 10 possible designs best fits your space and maximizes your garden.

MSRP: \$259.95



Product Features

- 10
DIFFERENT
CONFIGURATIONS
- 17
INCHES
TALL
- 20+
YEARS
DESIGN LIFE
- 50
MINUTES TO
ASSEMBLE
- 100%
RECYCLABLE
METAL

Configurations

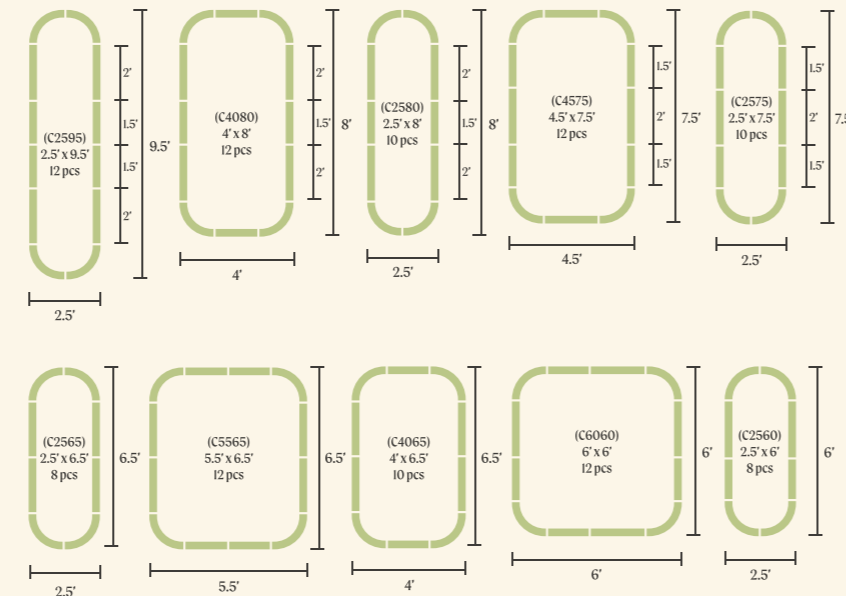



Model No. VB10N117BG



17" Tall 10 In 1-British Gray Modular Metal Raised Garden Bed Kit

10-in-1 is the Texas-sized garden bed! This kit offers a spacious growing area with configurations including 4' x 8', 2.5' x 9.5', 6' x 6' or 7 other options. You can choose which configuration of the 10 possible designs best fits your space and maximizes your garden.

MSRP: \$259.95



Product Features

- 10 DIFFERENT CONFIGURATIONS
- 17 INCHES TALL
- 20+ YEARS DESIGN LIFE
- 50 MINUTES TO ASSEMBLE
- 100% RECYCLABLE METAL

Configurations

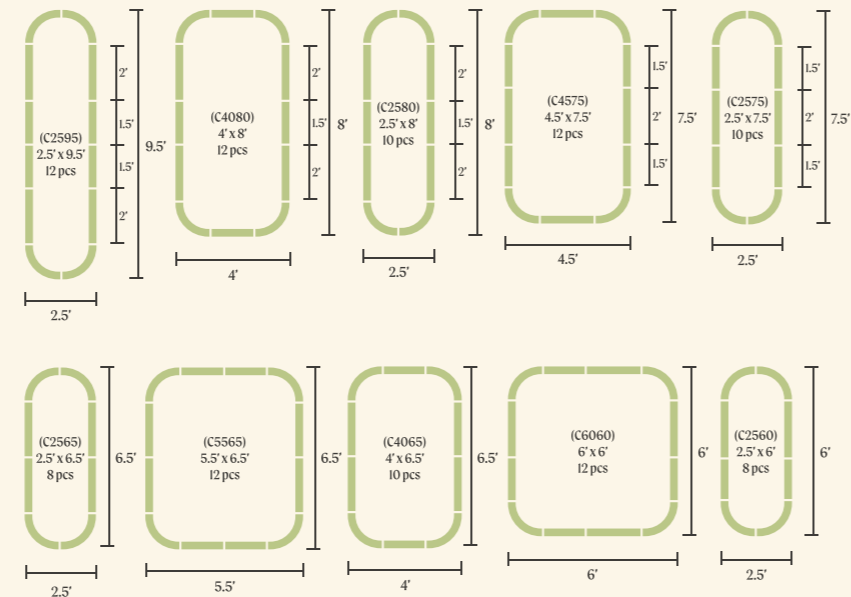



Model No.
VB10N117MG



17" Tall 10 In 1-Modern Green Modular Metal Raised Garden Bed Kit

10-in-1 is the Texas-sized garden bed! This kit offers a spacious growing area with configurations including 4' x 8', 2.5' x 9.5', 6' x 6' or 7 other options. You can choose which configuration of the 10 possible designs best fits your space and maximizes your garden.

MSRP: \$259.95



Product Features

- 10
DIFFERENT
CONFIGURATIONS
- 17
INCHES
TALL
- 20+
YEARS
DESIGN LIFE
- 50
MINUTES TO
ASSEMBLE
- 100%
RECYCLABLE
METAL

Configurations

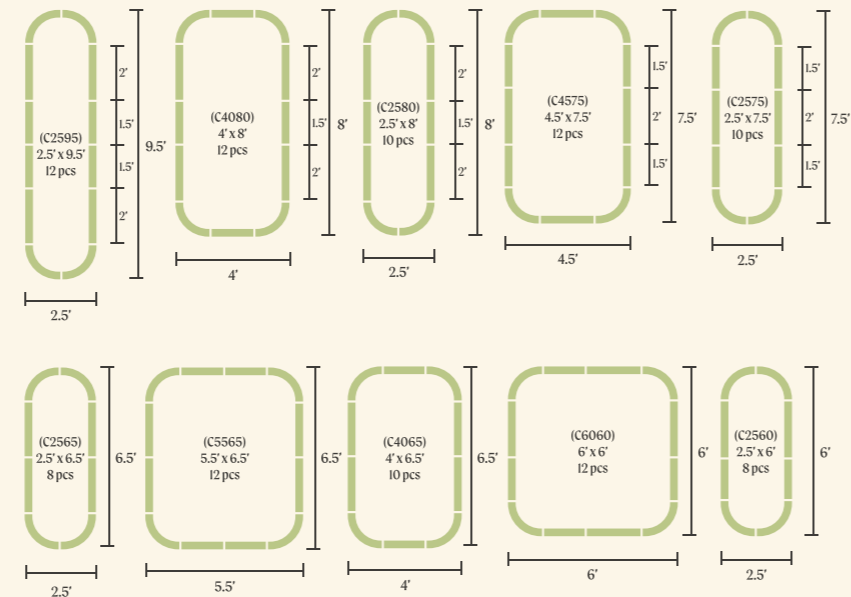

17" Tall 42" Wide Round-Pearl White Modular Metal Raised Garden Bed Kit

The 42" round bed is an ideal size for small veggie patches. The round shape makes it super easy to plant seeds or plant starts, which is a great fit for an extended patio for herbs, onions, strawberry patches and avocado trees.

MSRP: \$119.95



Product Features

- 17
INCHES
TALL
- 20+
YEARS
DESIGN LIFE
- 30
MINUTES TO
ASSEMBLE
- 100%
RECYCLABLE
METAL

Configurations



Round
 Diameter(in): 42"
 Height(in): 17"
 Thickness: 0.6mm
 Volume: 13.6cu ft



Model No.
VRB4217W



17" Tall 42" Wide Round-Olive Green Modular Metal Raised Garden Bed Kit

The 42" round bed is an ideal size for small veggie patches. The round shape makes it super easy to plant seeds or plant starts, which is a great fit for an extended patio for herbs, onions, strawberry patches and avocado trees.

MSRP: \$119.95



Product Features

- 17
INCHES
TALL
- 20+
YEARS
DESIGN LIFE
- 30
MINUTES TO
ASSEMBLE
- 100%
RECYCLABLE
METAL

Configurations



Round
Diameter(in): 42"
Height(in): 17"
Thickness: 0.6mm
Volume: 13.6cu ft



Model No.
VRB4217G



17" Tall 42" Wide Round-British Green Modular Metal Raised Garden Bed Kit

The 42" round bed is an ideal size for small veggie patches. The round shape makes it super easy to plant seeds or plant starts, which is a great fit for an extended patio for herbs, onions, strawberry patches and avocado trees.

MSRP: \$119.95



Product Features

- 17
INCHES
TALL
- 20+
YEARS
DESIGN LIFE
- 30
MINUTES TO
ASSEMBLE
- 100%
RECYCLABLE
METAL

Configurations



Round
Diameter(in): 42"
Height(in): 17"
Thickness: 0.6mm
Volume: 13.6cu ft



Model No.
VRB4217BG



17" Tall 42" Wide Round-Modern Gray Modular Metal Raised Garden Bed Kit

The 42" round bed is an ideal size for small veggie patches. The round shape makes it super easy to plant seeds or plant starts, which is a great fit for an extended patio for herbs, onions, strawberry patches and avocado trees.

MSRP: \$119.95



Product Features

- 17 INCHES TALL
- 20+ YEARS DESIGN LIFE
- 30 MINUTES TO ASSEMBLE
- 100% RECYCLABLE METAL

Configurations



Round
Diameter(in): 42"
Height(in): 17"
Thickness: 0.6mm
Volume: 13.6cu ft



Model No.
VRB4217MG

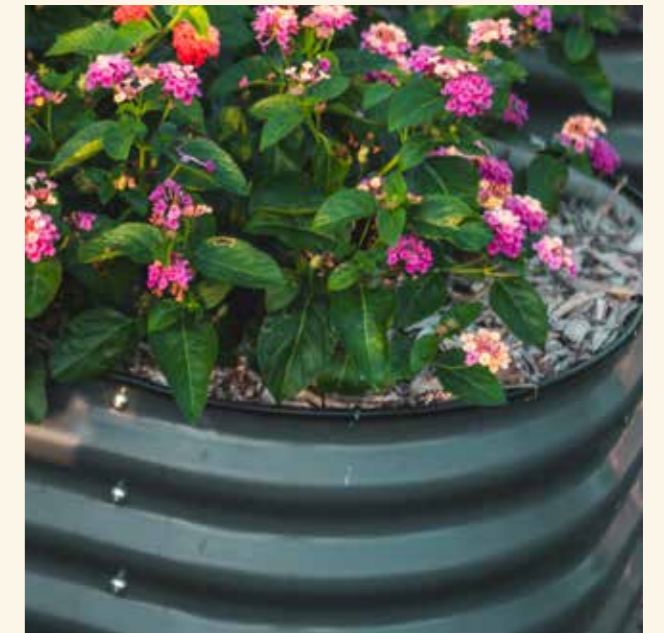

17" Tall 2' Wide Extension Kit-Pearl White

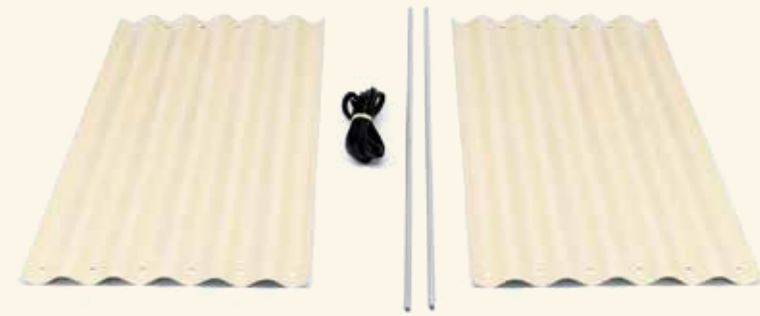

Model No	Rod Width
VE17W-BR25	2.5'
VE17W-BR35	3.5'
VE17W-BR40	4.0'
VE17W-BR45	4.5'



Configurations

- 2 ft. Extension Kit Includes:**
- 2 X Straight Panel (Each 2.0 ft. wide)
 - 2 X Bracing Rod (Select the width)
 - Hardware, Edging Cover

This kit will extend the length of your garden bed by 2 ft. With One Extension Kit. You can expand your 4 x 8 ft. bed into 4 x 10 ft., or 2.5 x 9.5 ft. into 2.5 x 11.5 ft. With Two extension kits, you can get a garden bed measuring 2.5 x 13.5 ft or 4 x 12 ft. It is just that simple.

17" Tall 2' Wide Extension Kit-Olive Green



Model No	Rod Width
VE17G-BR25	2.5'
VE17G-BR35	3.5'
VE17G-BR40	4.0'
VE17G-BR45	4.5'



Configurations

- 2 ft. Extension Kit Includes:**
- 2 X Straight Panel (Each 2.0 ft. wide)
 - 2 X Bracing Rod (Select the width)
 - Hardware, Edging Cover

This kit will extend the length of your garden bed by 2 ft. With One Extension Kit. You can expand your 4 x 8 ft. bed into 4 x 10 ft., or 2.5 x 9.5 ft. into 2.5 x 11.5 ft. With Two extension kits, you can get a garden bed measuring 2.5 x 13.5 ft or 4 x 12 ft. It is just that simple.

17" Tall 2' Wide Extension Kit-British Green



Model No	Rod Width
VE17BG-BR25	2.5'
VE17BG-BR35	3.5'
VE17BG-BR40	4.0'
VE17BG-BR45	4.5'



Configurations

- 2 ft. Extension Kit Includes:**
- 2 X Straight Panel (Each 2.0 ft. wide)
 - 2 X Bracing Rod (Select the width)
 - Hardware, Edging Cover

This kit will extend the length of your garden bed by 2 ft. With One Extension Kit. You can expand your 4 x 8 ft. bed into 4 x 10 ft., or 2.5 x 9.5 ft. into 2.5 x 11.5 ft. With Two extension kits, you can get a garden bed measuring 2.5 x 13.5 ft or 4 x 12 ft. It is just that simple.

17" Tall 2' Wide Extension Kit-Modern Gray



Model No	Rod Width
VE17MG-BR25	2.5'
VE17MG-BR35	3.5'
VE17MG-BR40	4.0'
VE17MG-BR45	4.5'



Configurations

- 2 ft. Extension Kit Includes:**
- 2 X Straight Panel (Each 2.0 ft. wide)
 - 2 X Bracing Rod (Select the width)
 - Hardware, Edging Cover

This kit will extend the length of your garden bed by 2 ft. With One Extension Kit. You can expand your 4 x 8 ft. bed into 4 x 10 ft., or 2.5 x 9.5 ft. into 2.5 x 11.5 ft. With Two extension kits, you can get a garden bed measuring 2.5 x 13.5 ft or 4 x 12 ft. It is just that simple.



32" Garden Beds



Model No.
VB4N132W



32" Extra Tall 4 In 1-Pearl White Modular Metal Raised Garden Bed Kit

There is no bending required when tending to our 32" Extra Tall raised beds, saving your back from strain. The higher depth also allows plenty of room to grow a myriad of vegetables and plants, which will flourish due to the ample space for root systems to develop, and better water drainage.

MSRP: \$209.95



Product Features

- 4
DIFFERENT
CONFIGURATIONS
- 32
INCHES
TALL
- 20+
YEARS
DESIGN LIFE
- 40
MINUTES TO
ASSEMBLE
- 100%
RECYCLABLE
METAL

Configurations

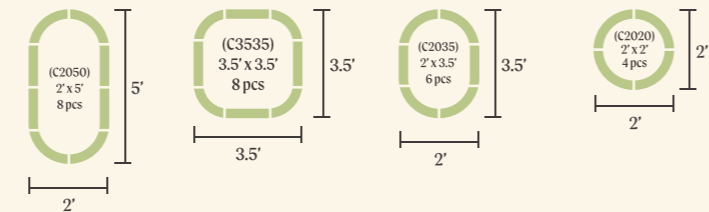



Model No.
VB4N132G



32" Extra Tall 4 In 1-Olive Green Modular Metal Raised Garden Bed Kit

There is no bending required when tending to our 32" Extra Tall raised beds, saving your back from strain. The higher depth also allows plenty of room to grow a myriad of vegetables and plants, which will flourish due to the ample space for root systems to develop, and better water drainage.

MSRP: \$209.95



Product Features

- 4
DIFFERENT
CONFIGURATIONS
- 32
INCHES
TALL
- 20+
YEARS
DESIGN LIFE
- 40
MINUTES TO
ASSEMBLE
- 100%
RECYCLABLE
METAL

Configurations

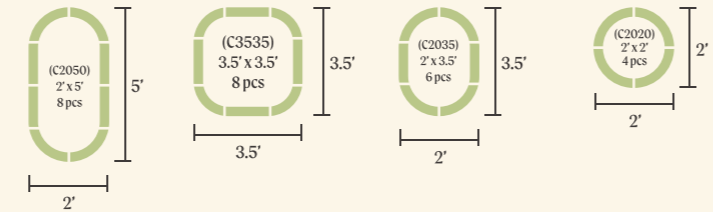



Model No.
VB4N132BG



32" Extra Tall 4 In 1-British Green Modular Metal Raised Garden Bed Kit

There is no bending required when tending to our 32" Extra Tall raised beds, saving your back from strain. The higher depth also allows plenty of room to grow a myriad of vegetables and plants, which will flourish due to the ample space for root systems to develop, and better water drainage.

MSRP: \$209.95



Product Features

- 4
DIFFERENT
CONFIGURATIONS
- 32
INCHES
TALL
- 20+
YEARS
DESIGN LIFE
- 40
MINUTES TO
ASSEMBLE
- 100%
RECYCLABLE
METAL

Configurations

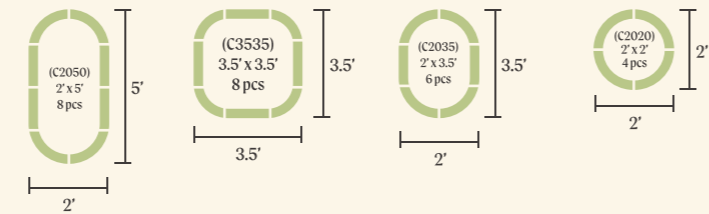



Model No.
VB4N132MG



32" Extra Tall 4 In 1-Modern Gray Modular Metal Raised Garden Bed Kit

There is no bending required when tending to our 32" Extra Tall raised beds, saving your back from strain. The higher depth also allows plenty of room to grow a myriad of vegetables and plants, which will flourish due to the ample space for root systems to develop, and better water drainage.

MSRP: \$209.95



Product Features

- 4
DIFFERENT
CONFIGURATIONS
- 32
INCHES
TALL
- 20+
YEARS
DESIGN LIFE
- 40
MINUTES TO
ASSEMBLE
- 100%
RECYCLABLE
METAL

Configurations

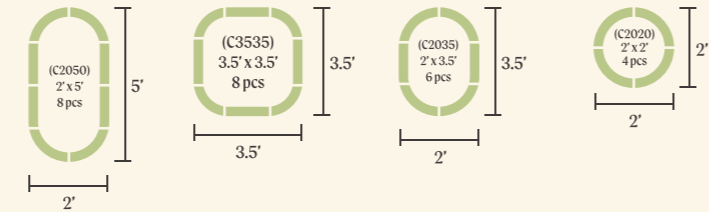



Model No.
VB6N132W



32" Extra Tall 6 In 1-Pearl White Modular Metal Raised Garden Bed Kit

There is no bending required for our extra tall raised beds. Our beds provide optimal space for you to plant larger vegetables with deep root systems, as well as smaller ones.

MSRP: \$249.95



Product Features

- 6
DIFFERENT
CONFIGURATIONS
- 32
INCHES
TALL
- 20+
YEARS
DESIGN LIFE
- 45
MINUTES TO
ASSEMBLE
- 100%
RECYCLABLE
METAL

Configurations

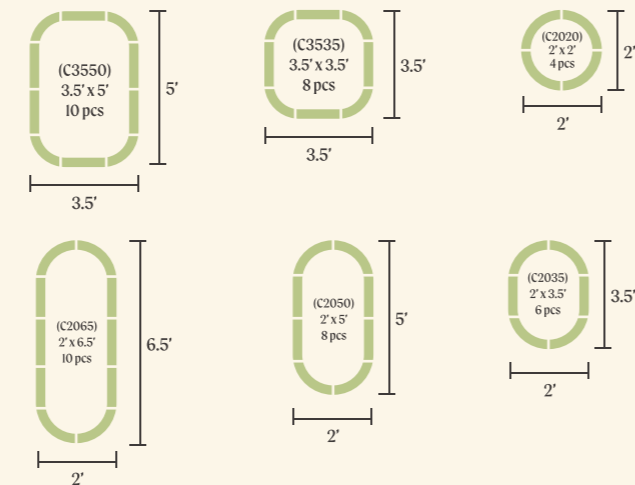



32" Extra Tall 6 In 1-Olive Green Modular Metal Raised Garden Bed Kit

There is no bending required for our extra tall raised beds. Our beds provide optimal space for you to plant larger vegetables with deep root systems, as well as smaller ones.

MSRP: \$249.95



Product Features

- 6
DIFFERENT
CONFIGURATIONS
- 32
INCHES
TALL
- 20+
YEARS
DESIGN LIFE
- 45
MINUTES TO
ASSEMBLE
- 100%
RECYCLABLE
METAL

Model No.
VB6N132G



Configurations

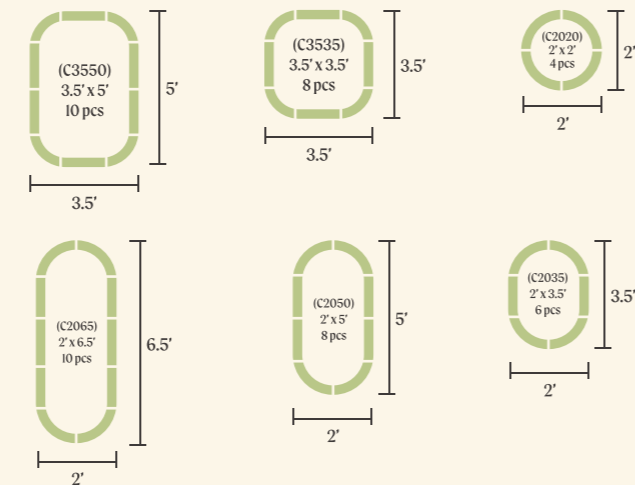



Model No. VB6N132BG



32" Extra Tall 6 In 1-British Green Modular Metal Raised Garden Bed Kit

There is no bending required for our extra tall raised beds. Our beds provide optimal space for you to plant larger vegetables with deep root systems, as well as smaller ones.

MSRP: \$249.95



Product Features

- 6
DIFFERENT
CONFIGURATIONS
- 32
INCHES
TALL
- 20+
YEARS
DESIGN LIFE
- 45
MINUTES TO
ASSEMBLE
- 100%
RECYCLABLE
METAL

Configurations

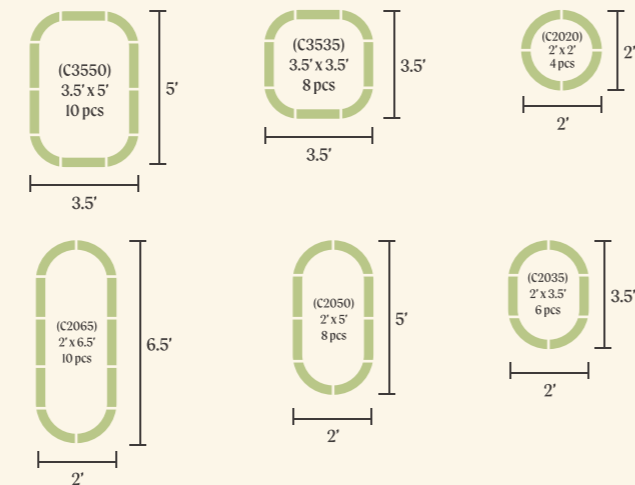

32" Extra Tall 6 In 1-Modern Green Modular Metal Raised Garden Bed Kit

There is no bending required for our extra tall raised beds. Our beds provide optimal space for you to plant larger vegetables with deep root systems, as well as smaller ones.

MSRP: \$249.95



Product Features

- 6
DIFFERENT
CONFIGURATIONS
- 32
INCHES
TALL
- 20+
YEARS
DESIGN LIFE
- 45
MINUTES TO
ASSEMBLE
- 100%
RECYCLABLE
METAL

Configurations

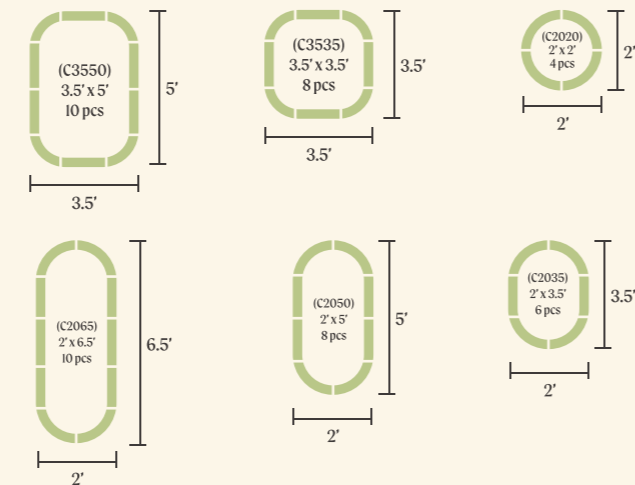

Model No.
VB6N132MG



32" Extra Tall 9 In 1-Pearl White Modular Metal Raised Garden Bed Kit

Our extra tall 32" height eliminates bending and strain on your back when you tend to your garden, as well as creates plenty of space for healthy roots.

MSRP: \$ 319.95



Product Features

- 9
DIFFERENT
CONFIGURATIONS
- 32
INCHES
TALL
- 20+
YEARS
DESIGN LIFE
- 50
MINUTES TO
ASSEMBLE
- 100%
RECYCLABLE
METAL

Configurations

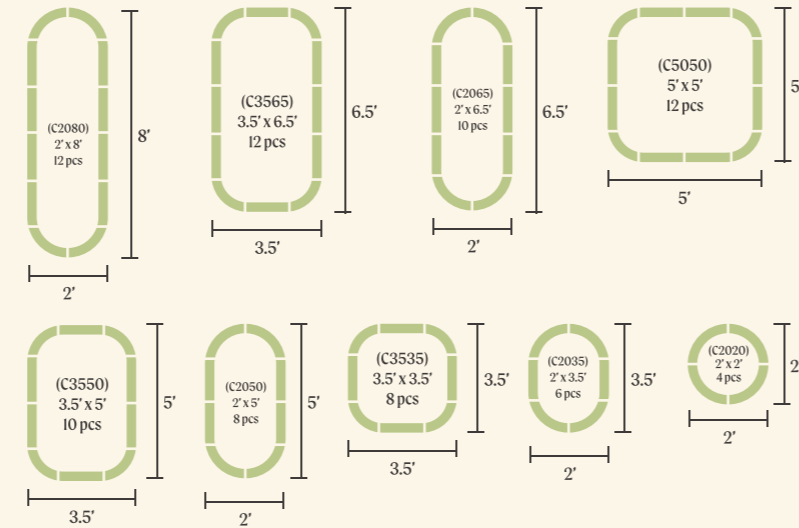

Model No.
VB9N132W





Model No.
VB9N132G



32" Extra Tall 9 In 1-Olive Green Modular Metal Raised Garden Bed Kit

Our extra tall 32" height eliminates bending and strain on your back when you tend to your garden, as well as creates plenty of space for healthy roots.

MSRP: \$ 319.95



Product Features

- 9
DIFFERENT
CONFIGURATIONS
- 32
INCHES
TALL
- 20+
YEARS
DESIGN LIFE
- 50
MINUTES TO
ASSEMBLE
- 100%
RECYCLABLE
METAL

Configurations

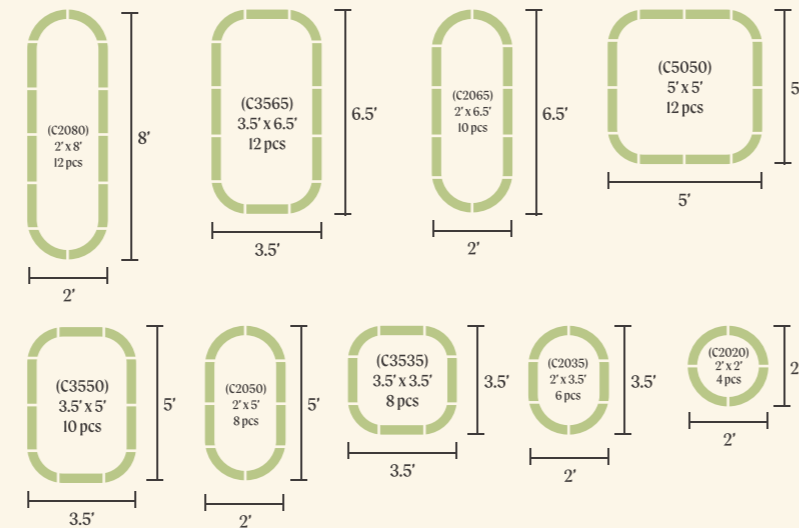

32" Extra Tall 9 In 1-British Green Modular Metal Raised Garden Bed Kit

Our extra tall 32" height eliminates bending and strain on your back when you tend to your garden, as well as creates plenty of space for healthy roots.

MSRP: \$ 319.95



Product Features

- 9
DIFFERENT
CONFIGURATIONS
- 32
INCHES
TALL
- 20+
YEARS
DESIGN LIFE
- 50
MINUTES TO
ASSEMBLE
- 100%
RECYCLABLE
METAL

Configurations

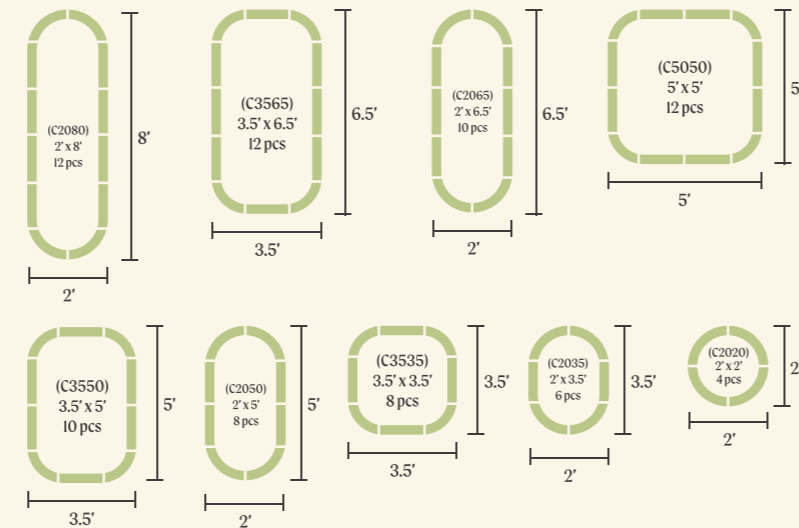

Model No.
VB9N132BG





Model No.
VB9N132MG



32" Extra Tall 9 In 1-Modern Gray Modular Metal Raised Garden Bed Kit

Our extra tall 32" height eliminates bending and strain on your back when you tend to your garden, as well as creates plenty of space for healthy roots.

MSRP: \$ 319.95



Product Features

- 9
DIFFERENT
CONFIGURATIONS
- 32
INCHES
TALL
- 20+
YEARS
DESIGN LIFE
- 50
MINUTES TO
ASSEMBLE
- 100%
RECYCLABLE
METAL

Configurations

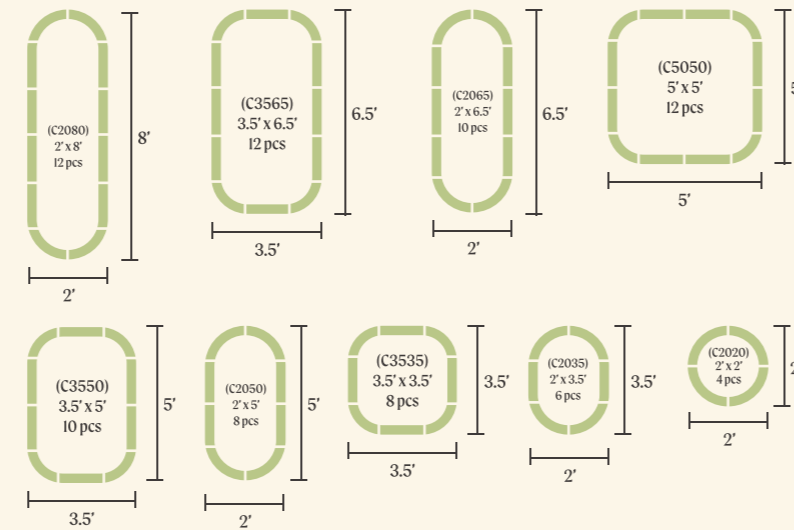



Model No.
VB10N132W



32" Extra Tall 10 In 1-Pearl White Modular Metal Raised Garden Bed Kit

You do not need to bend down at all to garden in our 32" extra tall beds. In addition, 32" is tall enough to accommodate both large and small vegetables, allowing you to further customize your garden.

MSRP: \$ 379.95



Product Features

- 10
DIFFERENT
CONFIGURATIONS
- 32
INCHES
TALL
- 20+
YEARS
DESIGN LIFE
- 60
MINUTES TO
ASSEMBLE
- 100%
RECYCLABLE
METAL

Configurations

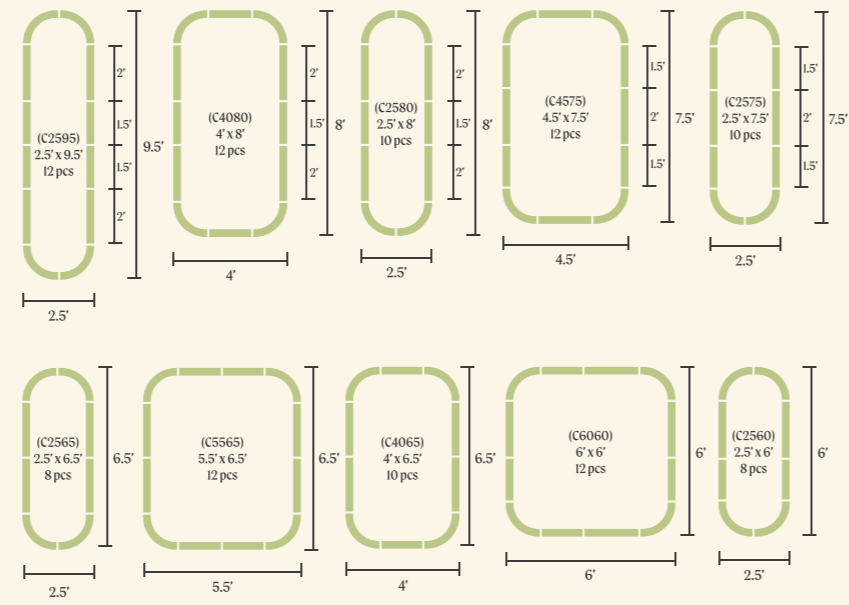



Model No.
VB10N132G



32" Extra Tall 10 In 1-Olive Green Modular Metal Raised Garden Bed Kit

You do not need to bend down at all to garden in our 32" extra tall beds. In addition, 32" is tall enough to accommodate both large and small vegetables, allowing you to further customize your garden.

MSRP: \$ 379.95



Product Features

- 10
DIFFERENT
CONFIGURATIONS
- 32
INCHES
TALL
- 20+
YEARS
DESIGN LIFE
- 60
MINUTES TO
ASSEMBLE
- 100%
RECYCLABLE
METAL

Configurations

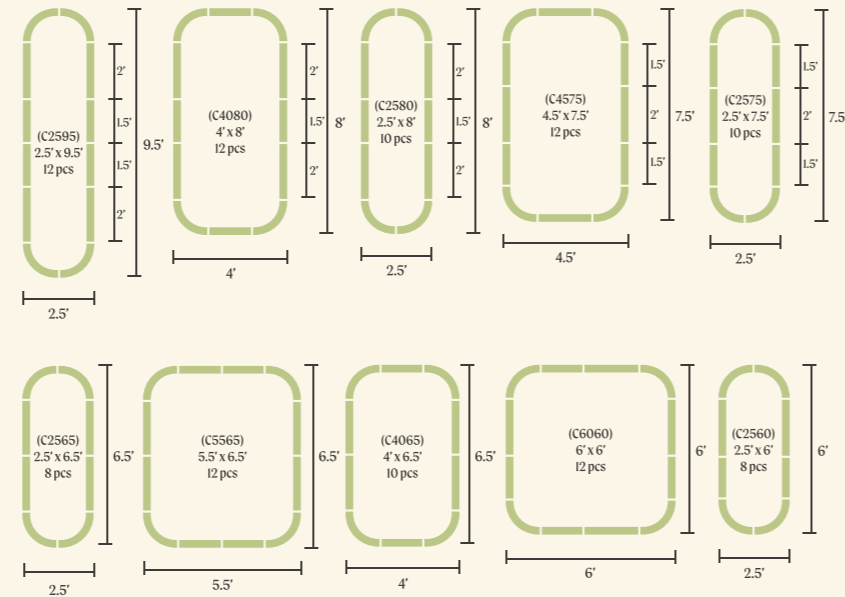



Model No. VB10N132BG



32" Extra Tall 10 In 1-British Green Modular Metal Raised Garden Bed Kit

You do not need to bend down at all to garden in our 32" extra tall beds. In addition, 32" is tall enough to accommodate both large and small vegetables, allowing you to further customize your garden.

MSRP: \$ 379.95



Product Features

- 10 DIFFERENT CONFIGURATIONS
- 32 INCHES TALL
- 20+ YEARS DESIGN LIFE
- 60 MINUTES TO ASSEMBLE
- 100% RECYCLABLE METAL

Configurations

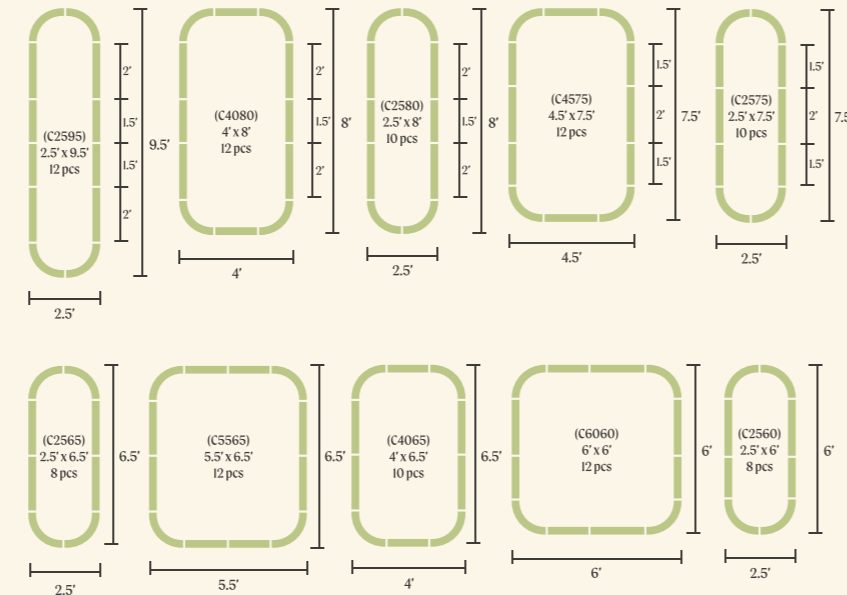



Model No.
VB10N132MG



32" Extra Tall 10 In 1-Modern Gray Modular Metal Raised Garden Bed Kit

You do not need to bend down at all to garden in our 32" extra tall beds. In addition, 32" is tall enough to accommodate both large and small vegetables, allowing you to further customize your garden.

MSRP: \$ 379.95



Product Features

- 10
DIFFERENT
CONFIGURATIONS
- 32
INCHES
TALL
- 20+
YEARS
DESIGN LIFE
- 60
MINUTES TO
ASSEMBLE
- 100%
RECYCLABLE
METAL

Configurations

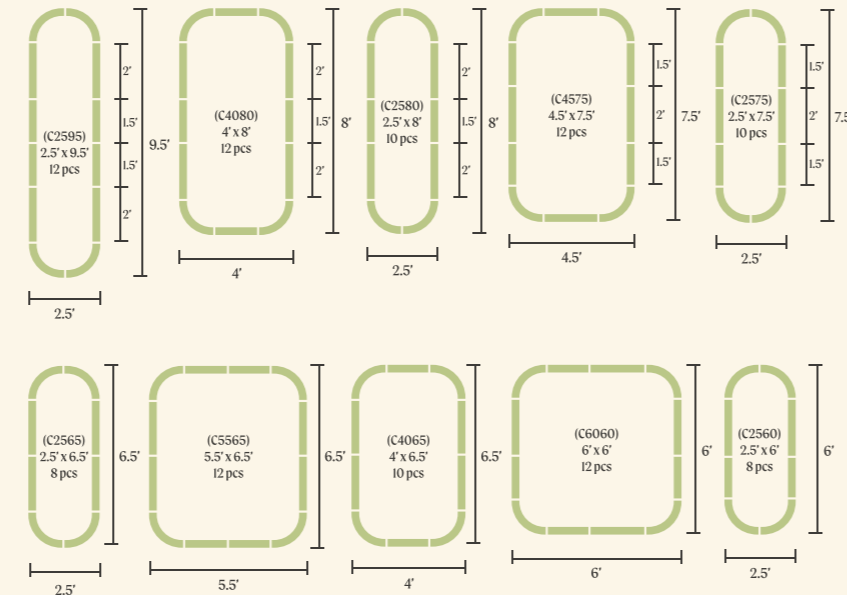

32" Extra Tall 42 Wide Round- Pearl White Metal Raised Garden Bed Kit

Featuring an elegant round design, the extra tall 42" round bed is the perfect addition to your backyard garden.

MSRP: \$199.95



Product Features

32 INCHES TALL		20+ YEARS DESIGN LIFE		30 MINUTES TO ASSEMBLE		100% RECYCLABLE METAL
----------------------	--	-----------------------------	--	------------------------------	--	-----------------------------

Configurations

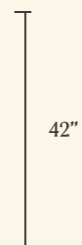

Round
Diameter(in): 42"
Height(in): 17"
Thickness: 0.6mm
Volume: 13.6cu ft

Model No.
VRB4232W

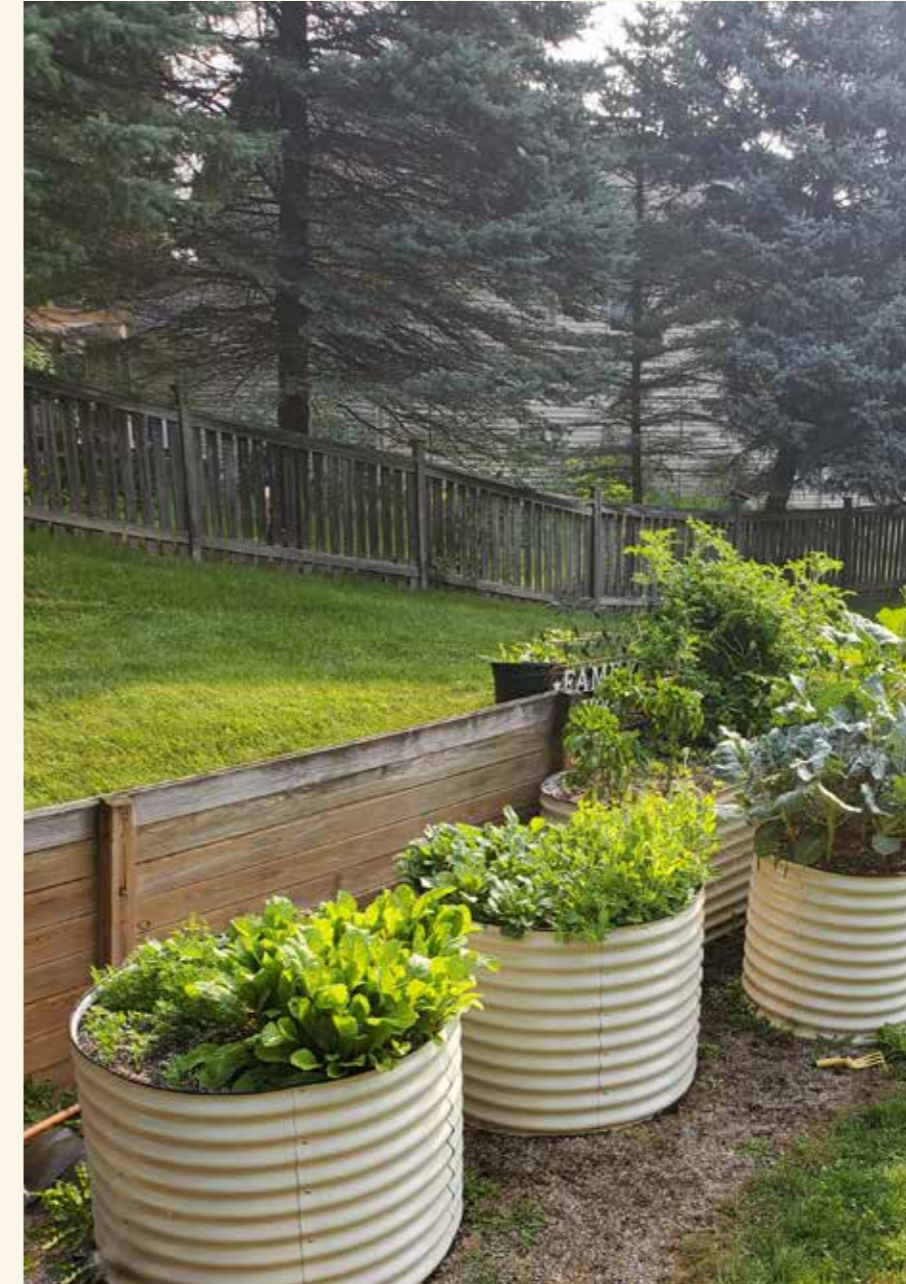

32" Extra Tall 42 Wide Round-Olive Green Metal Raised Garden Bed Kit

Featuring an elegant round design, the extra tall 42" round bed is the perfect addition to your backyard garden.

MSRP: \$199.95



Product Features

32 INCHES TALL		20+ YEARS DESIGN LIFE		30 MINUTES TO ASSEMBLE		100% RECYCLABLE METAL
----------------------	--	-----------------------------	--	------------------------------	--	-----------------------------

Configurations



Round
Diameter(in): 42"
Height(in): 17"
Thickness: 0.6mm
Volume: 13.6cu ft



Model No.
VRB4232G



32" Extra Tall 42 Wide Round-British Green Metal Raised Garden Bed Kit

Featuring an elegant round design, the extra tall 42" round bed is the perfect addition to your backyard garden.

MSRP: \$199.95



Product Features

32 INCHES TALL		20+ YEARS DESIGN LIFE		30 MINUTES TO ASSEMBLE		100% RECYCLABLE METAL
----------------------	--	-----------------------------	--	------------------------------	--	-----------------------------

Configurations



Round
Diameter(in): 42"
Height(in): 17"
Thickness: 0.6mm
Volume: 13.6cu ft

Model No.
VRB4232BG



32" Extra Tall 42 Wide Round- Modern Gray Metal Raised Garden Bed Kit

Featuring an elegant round design, the extra tall 42" round bed is the perfect addition to your backyard garden.

MSRP: \$199.95



Product Features

32 INCHES TALL	20+ YEARS DESIGN LIFE	30 MINUTES TO ASSEMBLE	100% RECYCLABLE METAL
----------------------	-----------------------------	------------------------------	-----------------------------

Configurations

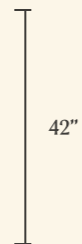

Round

Diameter(in): 42"

Height(in): 17"

Thickness: 0.6mm

Volume: 13.6cu ft

Model No.
VRB4232MG

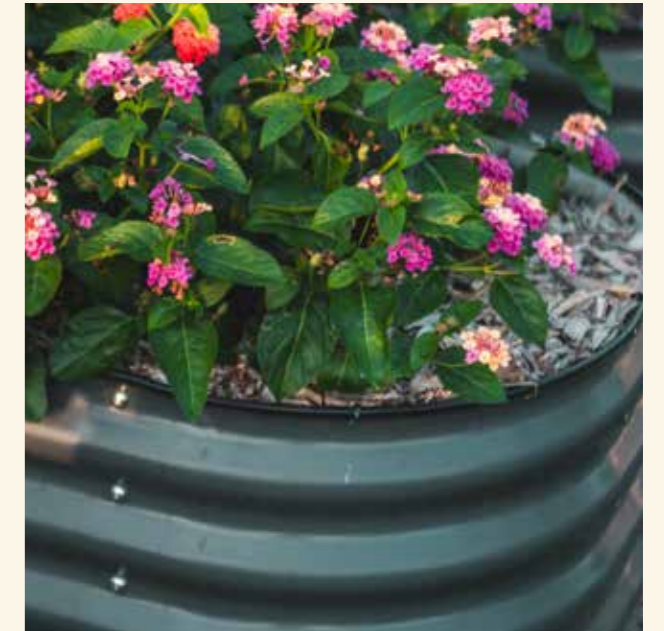

32" Tall 2' Wide Extension Kit-Pearl White



Model No	Rod Width
VE32W-BR25	2.5'
VE32W-BR35	3.5'
VE32W-BR40	4.0'
VE32W-BR45	4.5'



Configurations

2 ft. Extension Kit Includes:

- 2 X Straight Panel (Each 2.0 ft. wide)
- 2 X Bracing Rod (Select the width)
- Hardware, Edging Cover

This kit will extend the length of your garden bed by 2 ft. With One Extension Kit. You can expand your 4 x 8 ft. bed into 4 x 10 ft., or 2.5 x 9.5 ft. into 2.5 x 11.5 ft. With Two extension kits, you can get a garden bed measuring 2.5 x 13.5 ft or 4 x 12 ft. It is just that simple.

32" Tall 2' Wide Extension Kit-Olive Green



Model No	Rod Width
VE32G-BR25	2.5'
VE32G-BR35	3.5'
VE32G-BR40	4.0'
VE32G-BR45	4.5'



Configurations

2 ft. Extension Kit Includes:

- 2 X Straight Panel (Each 2.0 ft. wide)
- 2 X Bracing Rod (Select the width)
- Hardware, Edging Cover

This kit will extend the length of your garden bed by 2 ft. With One Extension Kit. You can expand your 4 x 8 ft. bed into 4 x 10 ft., or 2.5 x 9.5 ft. into 2.5 x 11.5 ft. With Two extension kits, you can get a garden bed measuring 2.5 x 13.5 ft or 4 x 12 ft. It is just that simple.

32" Tall 2' Wide Extension Kit-British Green



Model No	Rod Width
VE32BG-BR25	2.5'
VE32BG-BR35	3.5'
VE32BG-BR40	4.0'
VE32BG-BR45	4.5'



Configurations

2 ft. Extension Kit Includes:

- 2 X Straight Panel (Each 2.0 ft. wide)
- 2 X Bracing Rod (Select the width)
- Hardware, Edging Cover

This kit will extend the length of your garden bed by 2 ft. With One Extension Kit. You can expand your 4 x 8 ft. bed into 4 x 10 ft., or 2.5 x 9.5 ft. into 2.5 x 11.5 ft. With Two extension kits, you can get a garden bed measuring 2.5 x 13.5 ft or 4 x 12 ft. It is just that simple.

32" Tall 2' Wide Extension Kit-Modern Gray



Model No	Rod Width
VE32MG-BR25	2.5'
VE32MG-BR35	3.5'
VE32MG-BR40	4.0'
VE32MG-BR45	4.5'



Configurations

2 ft. Extension Kit Includes:

- 2 X Straight Panel (Each 2.0 ft. wide)
- 2 X Bracing Rod (Select the width)
- Hardware, Edging Cover

This kit will extend the length of your garden bed by 2 ft. With One Extension Kit. You can expand your 4 x 8 ft. bed into 4 x 10 ft., or 2.5 x 9.5 ft. into 2.5 x 11.5 ft. With Two extension kits, you can get a garden bed measuring 2.5 x 13.5 ft or 4 x 12 ft. It is just that simple.



Special Shapes

17" Tall L- Standard Size-Pearl White Shaped Raised Garden Bed Kit

Our L-Shaped design offers a striking configuration perfect for corners, giving you access to more growing space for your vegetables, flowers, and other plants.

MSRP: \$269.95



Product Features

17
INCHES
TALL

20+
YEARS
DESIGN LIFE

45
MINUTES TO
ASSEMBLE

100%
RECYCLABLE
METAL

Configurations

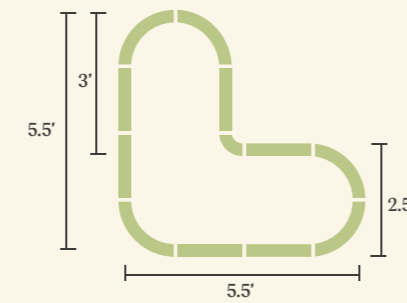

L-Shaped Standard

W x L x H: 5.5' x 5.5' x 17"

Grow Area (sq ft): 21.25

Cubic Feet: 30

Cubic Yard: 1.1



Model No.
VBLST17W

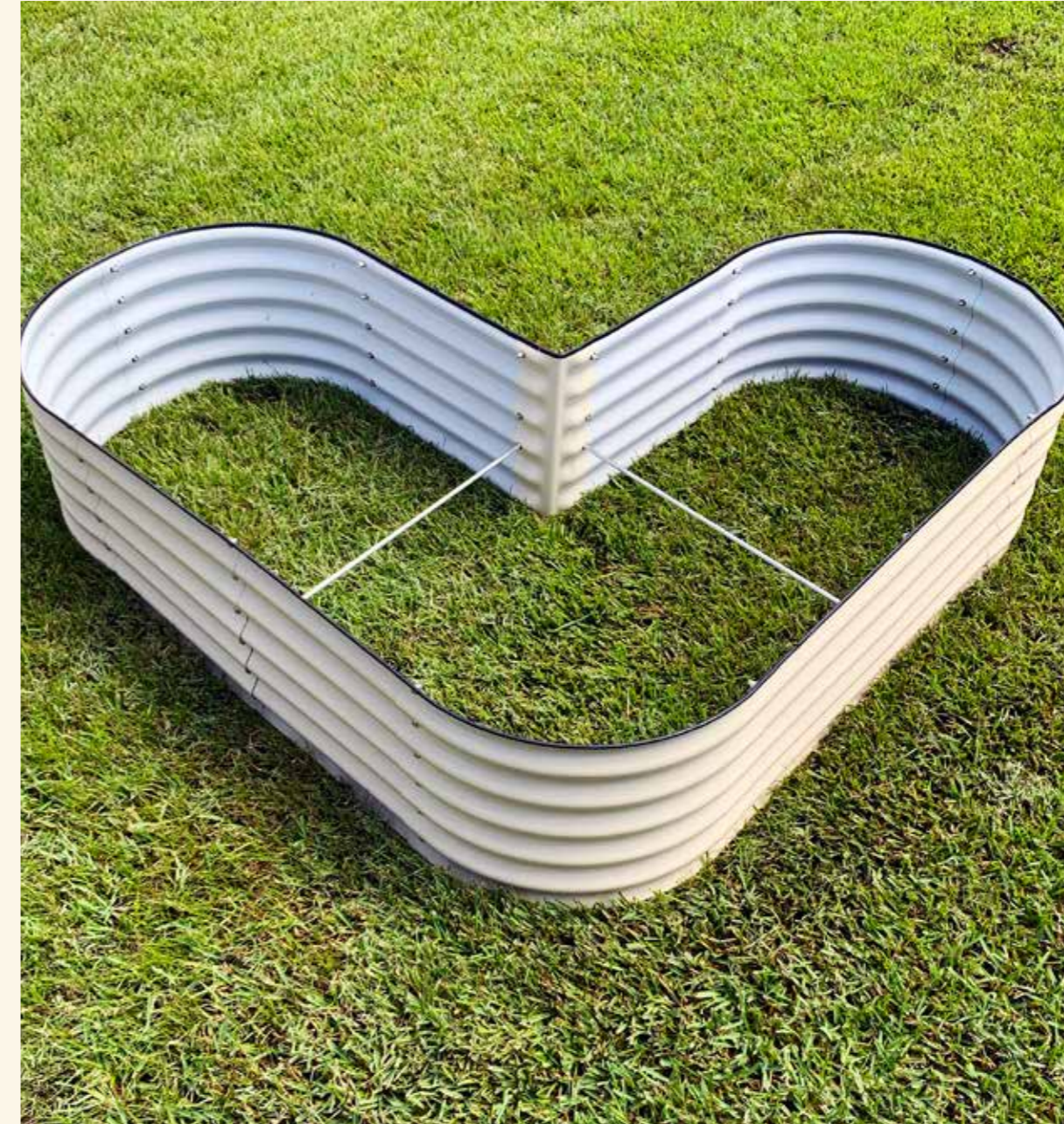

17" Tall L- Standard Size-Olive Green Shaped Raised Garden Bed Kit

Our L-Shaped design offers a striking configuration perfect for corners, giving you access to more growing space for your vegetables, flowers, and other plants.

MSRP: \$269.95



Product Features

- 17
INCHES
TALL
- 20+
YEARS
DESIGN LIFE
- 45
MINUTES TO
ASSEMBLE
- 100%
RECYCLABLE
METAL

Configurations

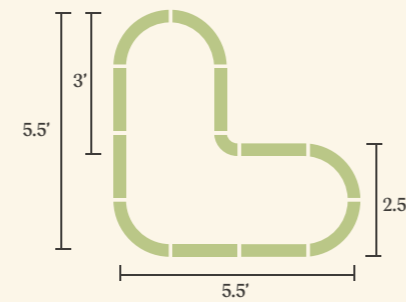

L-Shaped Standard

W x L x H: 5.5' x 5.5' x 17"

Grow Area (sq ft): 21.25

Cubic Feet: 30

Cubic Yard: 1.1



Model No.
VBLST17G

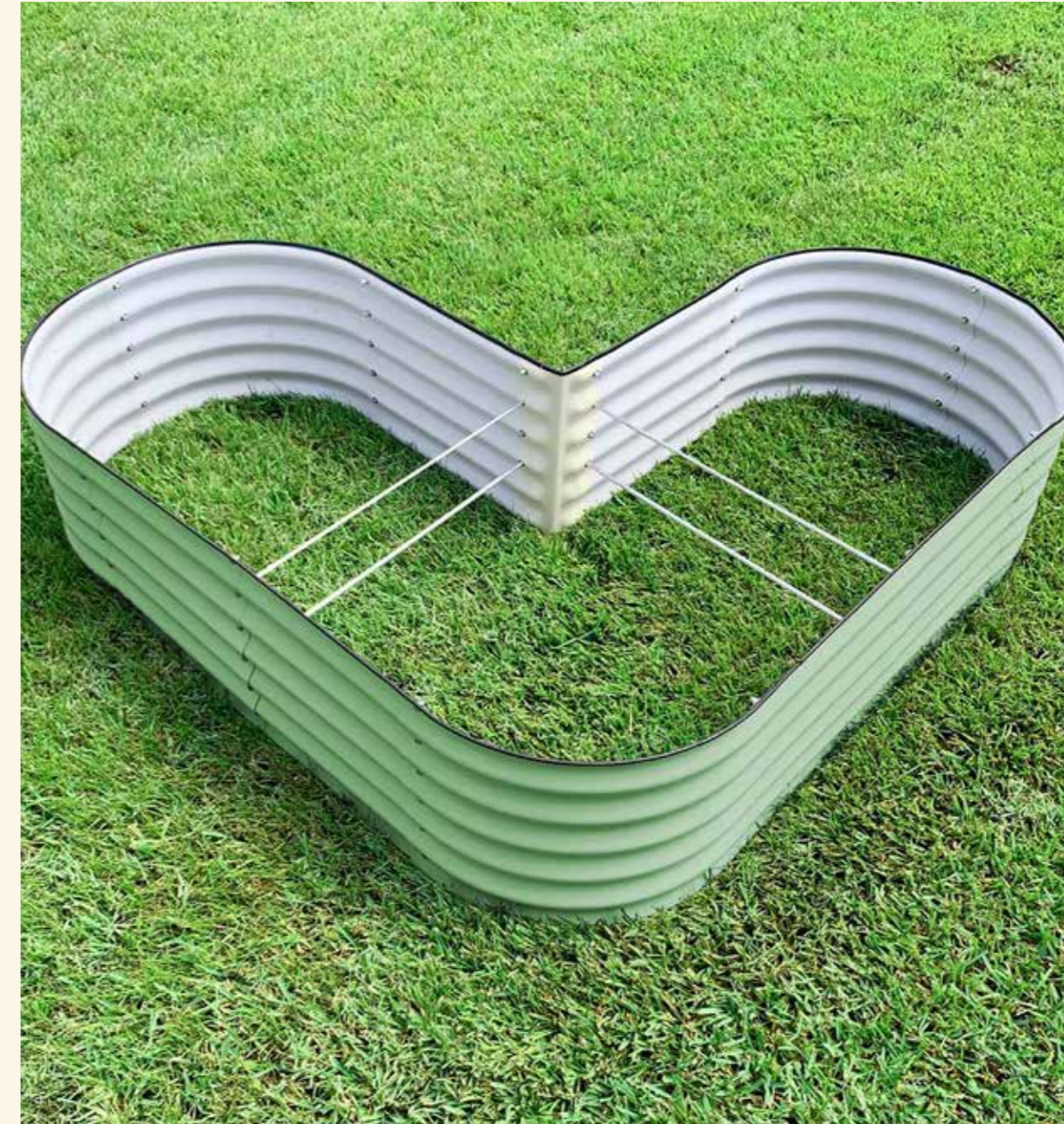

17" Tall L- Standard Size-British Green Shaped Raised Garden Bed Kit

Our L-Shaped design offers a striking configuration perfect for corners, giving you access to more growing space for your vegetables, flowers, and other plants.

MSRP: \$269.95



Product Features

- 17
INCHES
TALL
- 20+
YEARS
DESIGN LIFE
- 45
MINUTES TO
ASSEMBLE
- 100%
RECYCLABLE
METAL

Configurations

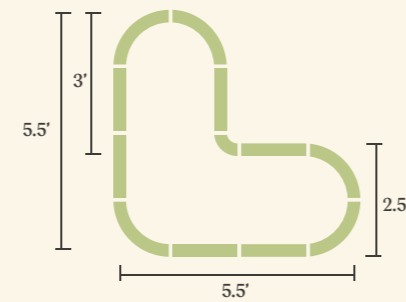

L-Shaped Standard

W x L x H: 5.5' x 5.5' x 17"

Grow Area (sq ft): 21.25

Cubic Feet: 30

Cubic Yard: 1.1



Model No.
VBLST17BG

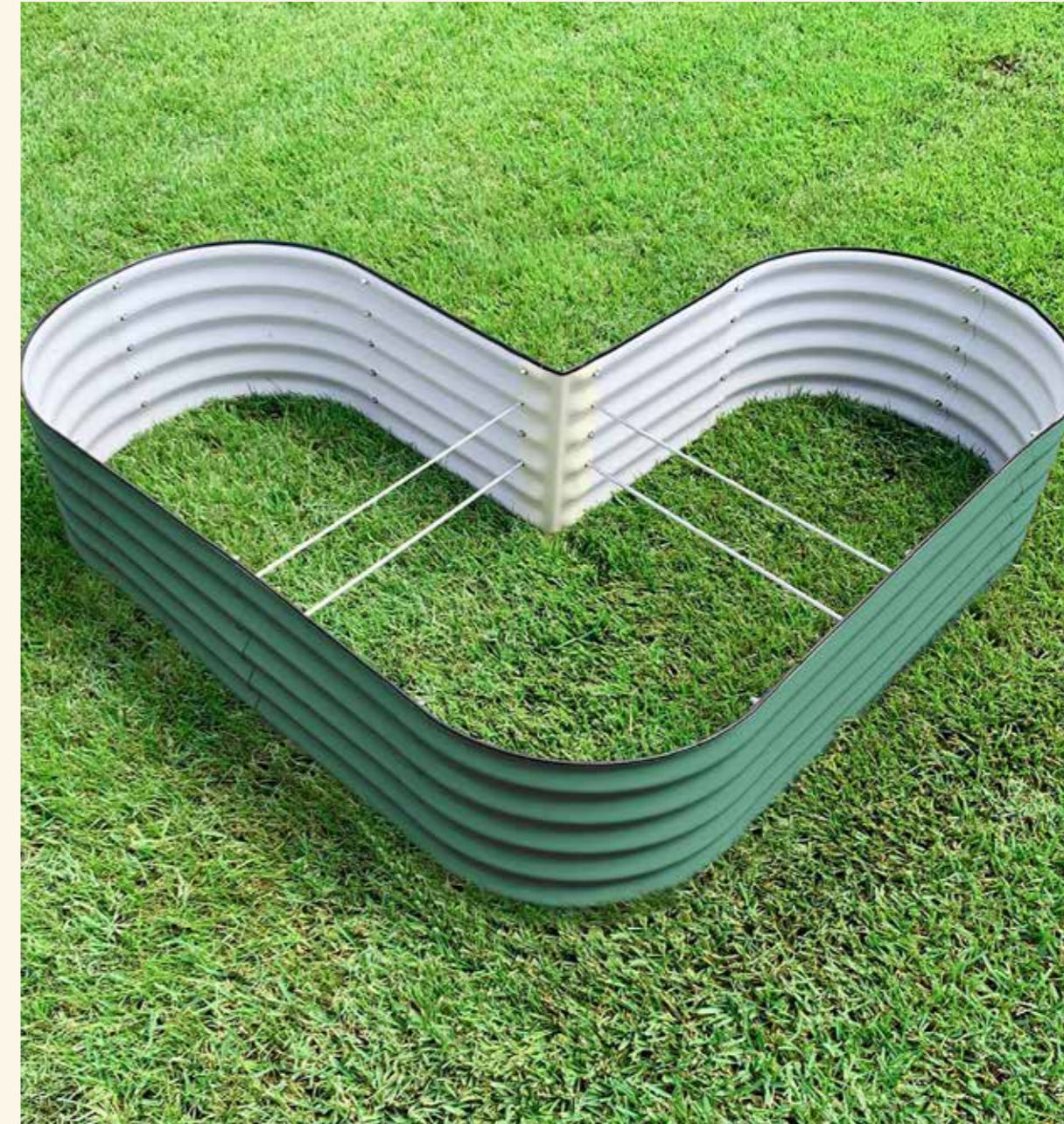

17" Tall L- Standard Size-Modern Gary Shaped Raised Garden Bed Kit

Our L-Shaped design offers a striking configuration perfect for corners, giving you access to more growing space for your vegetables, flowers, and other plants.

MSRP: \$269.95



Product Features

- 17 INCHES TALL
- 20+ YEARS DESIGN LIFE
- 45 MINUTES TO ASSEMBLE
- 100% RECYCLABLE METAL

Configurations

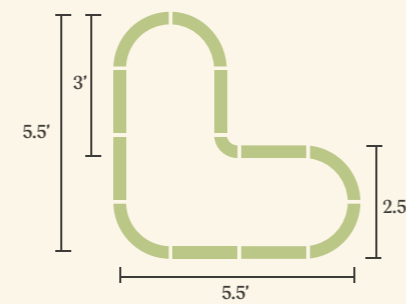

L-Shaped Standard

W x L x H: 5.5' x 5.5' x 17"

Grow Area (sq ft): 21.25

Cubic Feet: 30

Cubic Yard: 1.1



Model No. **VBLST17MG**

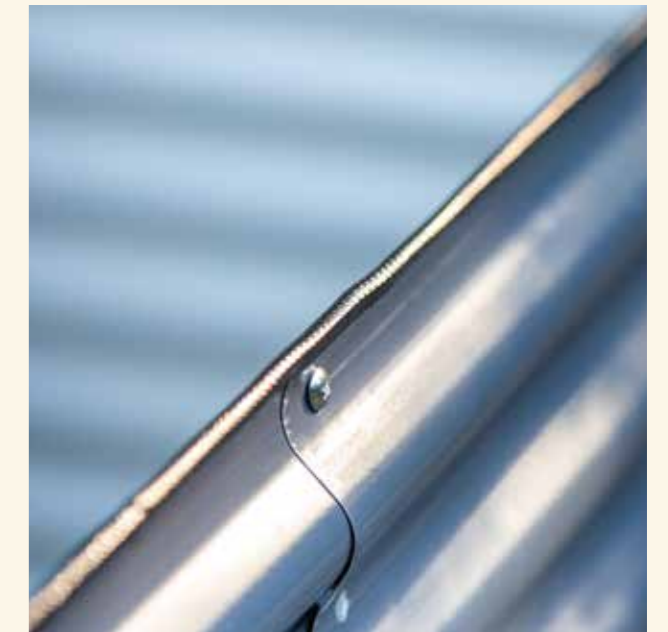

17" Tall L- Large Size-Pearl White Shaped Raised Garden Bed Kit

Our L-Shaped design offers a striking configuration perfect for corners, giving you access to more growing space for your vegetables, flowers, and other plants.

MSRP: \$369.95



Product Features

- 17
INCHES
TALL
- 20+
YEARS
DESIGN LIFE
- 60
MINUTES TO
ASSEMBLE
- 100%
RECYCLABLE
METAL

Configurations

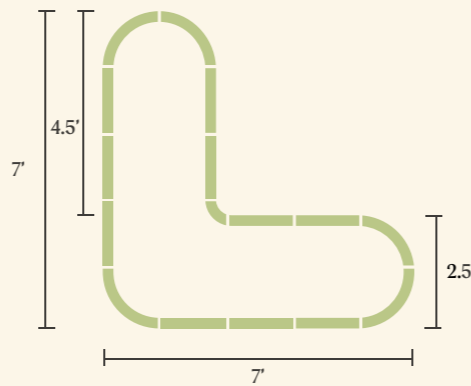

L-Shaped Large

W x L x H: 7' x 7' x 17"

Grow Area (sq ft): 28.75

Cubic Feet: 41

Cubic Yard: 1.5



Model No.
VBLLG17W



17" Tall L- Large Size-Olive Green Shaped Raised Garden Bed Kit

Our L-Shaped design offers a striking configuration perfect for corners, giving you access to more growing space for your vegetables, flowers, and other plants.

MSRP: \$369.95



Product Features

- 17
INCHES
TALL
- 20+
YEARS
DESIGN LIFE
- 60
MINUTES TO
ASSEMBLE
- 100%
RECYCLABLE
METAL

Configurations

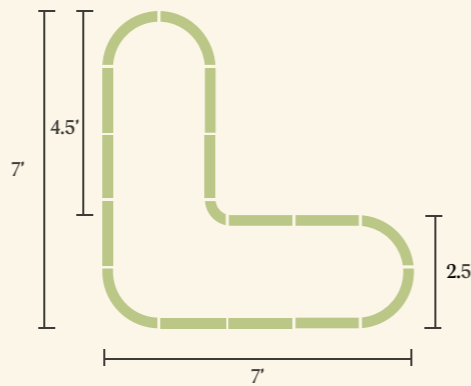

L-Shaped Large

W x L x H: 7' x 7' x 17"

Grow Area (sq ft): 28.75

Cubic Feet: 41

Cubic Yard: 1.5



Model No.
VBLLG17G



17" Tall L- Large Size-British Green Shaped Raised Garden Bed Kit

Our L-Shaped design offers a striking configuration perfect for corners, giving you access to more growing space for your vegetables, flowers, and other plants.

MSRP: \$369.95



Product Features

- 17
INCHES
TALL
- 20+
YEARS
DESIGN LIFE
- 60
MINUTES TO
ASSEMBLE
- 100%
RECYCLABLE
METAL

Configurations

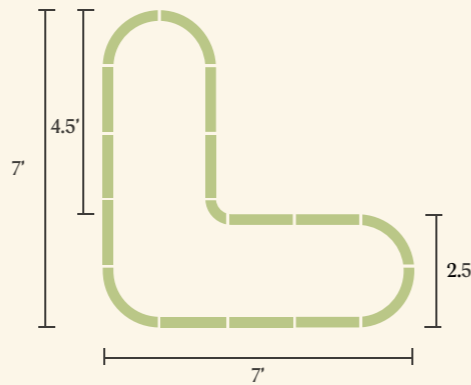

L-Shaped Large

W x L x H: 7' x 7' x 17"

Grow Area (sq ft): 28.75

Cubic Feet: 41

Cubic Yard: 1.5



Model No.
VBLLG17BG



17" Tall L- Large Size-Modern Gray Shaped Raised Garden Bed Kit

Our L-Shaped design offers a striking configuration perfect for corners, giving you access to more growing space for your vegetables, flowers, and other plants.

MSRP: \$369.95



Product Features

- 17
INCHES
TALL
- 20+
YEARS
DESIGN LIFE
- 60
MINUTES TO
ASSEMBLE
- 100%
RECYCLABLE
METAL

Configurations

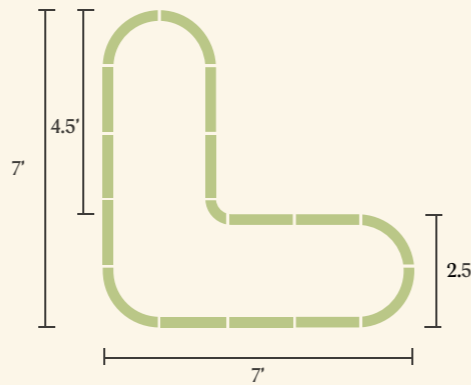

L-Shaped Large

W x L x H: 7' x 7' x 17"

Grow Area (sq ft): 28.75

Cubic Feet: 41

Cubic Yard: 1.5



Model No.
VBLLG17MG

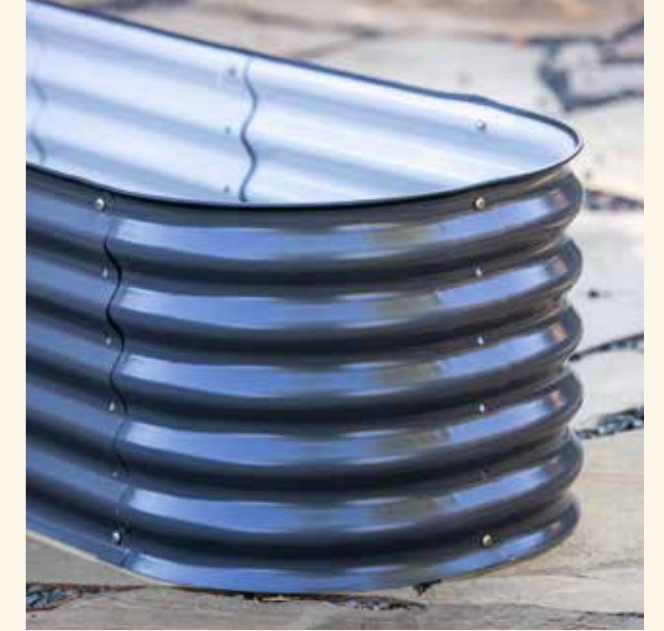

17" Tall U- Standard Size-Pearl White Shaped Raised Garden Bed Kit

Our U-Shaped design offers a convenient wrap-around configuration, giving you easy access to more growing space for your fresh vegetables, herbs and flowers.

MSRP: \$369.95



Product Features

8
OPEN
SIDES

17
INCHES
TALL

20+
YEARS
DESIGN LIFE

90
MINUTES TO
ASSEMBLE

100%
RECYCLABLE
METAL

Configurations

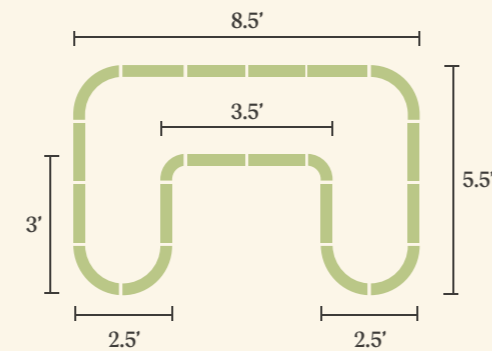

U-Shaped Standard

W x L x H: 5.5' x 8.5' x 17"

Grow Area (sq ft): 36

Cubic Feet: 51

Cubic Yard: 1.9



Model No.
VBUST17W



17" Tall U- Standard Size-Olive Green Shaped Raised Garden Bed Kit

Our U-Shaped design offers a convenient wrap-around configuration, giving you easy access to more growing space for your fresh vegetables, herbs and flowers.

MSRP: \$369.95



Product Features

8 OPEN SIDES		17 INCHES TALL		20+ YEARS DESIGN LIFE		90 MINUTES TO ASSEMBLE		100% RECYCLABLE METAL
--------------------	--	----------------------	--	-----------------------------	--	------------------------------	--	-----------------------------

Configurations

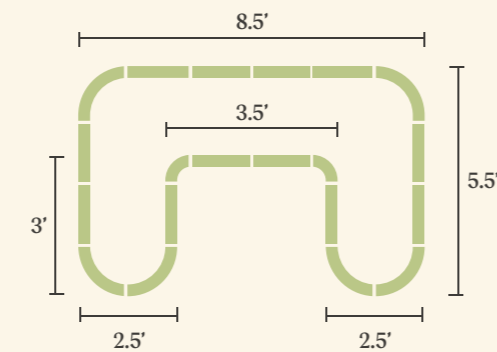

U-Shaped Standard

W x L x H: 5.5' x 8.5' x 17"

Grow Area (sq ft): 36

Cubic Feet: 51

Cubic Yard: 1.9



Model No.
VBUST17G



17" Tall U- Standard Size-British Green Shaped Raised Garden Bed Kit

Our U-Shaped design offers a convenient wrap-around configuration, giving you easy access to more growing space for your fresh vegetables, herbs and flowers.

MSRP: \$369.95



Product Features

- 8
OPEN
SIDES
- 17
INCHES
TALL
- 20+
YEARS
DESIGN LIFE
- 90
MINUTES TO
ASSEMBLE
- 100%
RECYCLABLE
METAL

Configurations

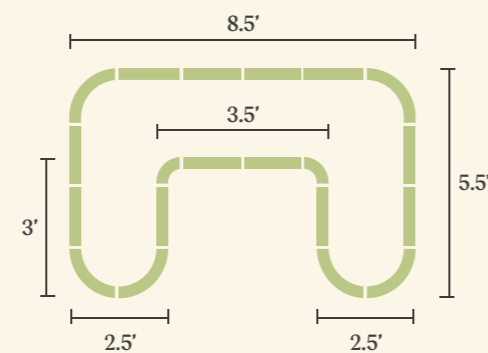

U-Shaped Standard

W x L x H: 5.5' x 8.5' x 17"

Grow Area (sq ft): 36

Cubic Feet: 51

Cubic Yard: 1.9



Model No.
VBUST17BG



17" Tall U- Standard Size-Modern Green Shaped Raised Garden Bed Kit

Our U-Shaped design offers a convenient wrap-around configuration, giving you easy access to more growing space for your fresh vegetables, herbs and flowers.

MSRP: \$369.95



Product Features

8
OPEN
SIDES

17
INCHES
TALL

20+
YEARS
DESIGN LIFE

90
MINUTES TO
ASSEMBLE

100%
RECYCLABLE
METAL

Configurations

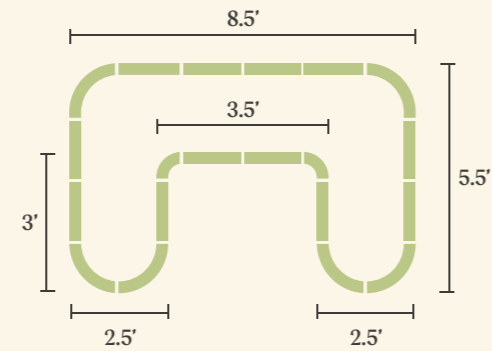

U-Shaped Standard

W x L x H: 5.5' x 8.5' x 17"

Grow Area (sq ft): 36

Cubic Feet: 51

Cubic Yard: 1.9



Model No.
VBUST17MG



17" Tall U- Large Size-Pearl White Shaped Raised Garden Bed Kit

Our U-Shaped design offers a convenient wrap-around configuration, giving you easy access to more growing space for your fresh vegetables, herbs and flowers.

MSRP: \$499.95



Product Features

- 8
OPEN
SIDES
- 17
INCHES
TALL
- 20+
YEARS
DESIGN LIFE
- 105
MINUTES TO
ASSEMBLE
- 100%
RECYCLABLE
METAL

Configurations

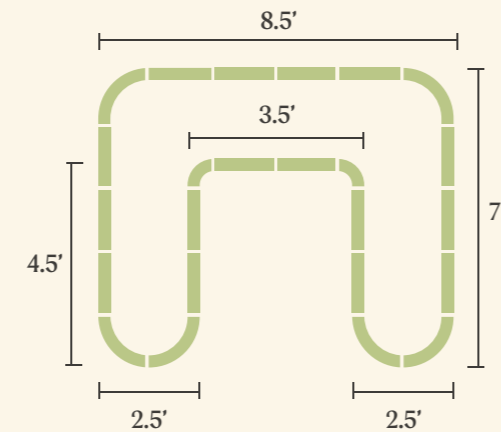

U-Shaped Large

W x L x H: 5.5' x 8.5' x 17"
 Grow Area (sq ft): 36
 Cubic Feet: 51
 Cubic Yard: 1.9



Model No.
VBULG17W



17" Tall U- Large Size-Olive Green Shaped Raised Garden Bed Kit

Our U-Shaped design offers a convenient wrap-around configuration, giving you easy access to more growing space for your fresh vegetables, herbs and flowers.

MSRP: \$499.95



Product Features

- 8
OPEN
SIDES
- 17
INCHES
TALL
- 20+
YEARS
DESIGN LIFE
- 105
MINUTES TO
ASSEMBLE
- 100%
RECYCLABLE
METAL

Configurations

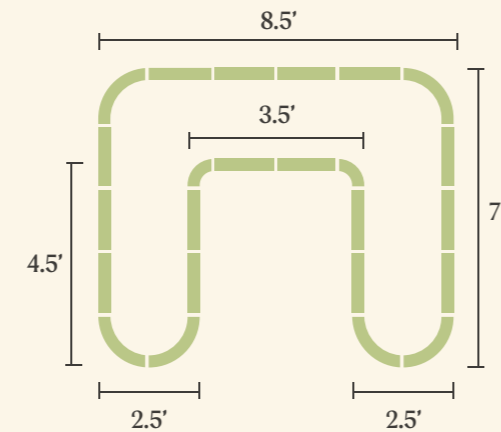

U-Shaped Large

W x L x H: 5.5' x 8.5' x 17"
 Grow Area (sq ft): 36
 Cubic Feet: 51
 Cubic Yard: 1.9



Model No.
VBULG17G



17" Tall U- Large Size-British Green Shaped Raised Garden Bed Kit

Our U-Shaped design offers a convenient wrap-around configuration, giving you easy access to more growing space for your fresh vegetables, herbs and flowers.

MSRP: \$499.95



Product Features

- 8
OPEN
SIDES
- 17
INCHES
TALL
- 20+
YEARS
DESIGN LIFE
- 105
MINUTES TO
ASSEMBLE
- 100%
RECYCLABLE
METAL

Configurations

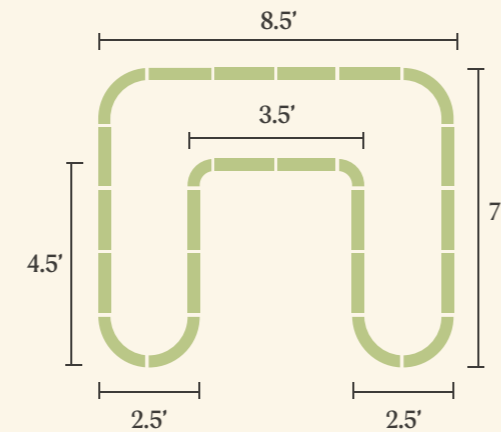

U-Shaped Large

W x L x H: 5.5' x 8.5' x 17"
 Grow Area (sq ft): 36
 Cubic Feet: 51
 Cubic Yard: 1.9



Model No.
VBULG17BG



17" Tall U- Large Size-Modern Gray Shaped Raised Garden Bed Kit

Our U-Shaped design offers a convenient wrap-around configuration, giving you easy access to more growing space for your fresh vegetables, herbs and flowers.

MSRP: \$499.95



Product Features

- 8
OPEN
SIDES
- 17
INCHES
TALL
- 20+
YEARS
DESIGN LIFE
- 105
MINUTES TO
ASSEMBLE
- 100%
RECYCLABLE
METAL

Configurations

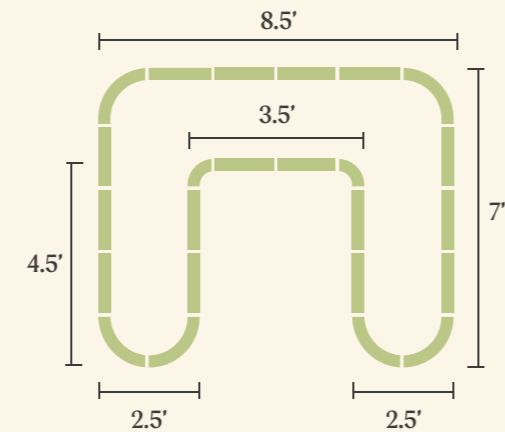

U-Shaped Large

W x L x H: 5.5' x 8.5' x 17"
 Grow Area (sq ft): 36
 Cubic Feet: 51
 Cubic Yard: 1.9



Model No.
VBULG17W



17" Tall U- Jumbo Size-Pearl White Shaped Raised Garden Bed Kit

Our U-Shaped design offers a convenient wrap-around configuration, giving you easy access to more growing space for your fresh vegetables, herbs and flowers.

MSRP: \$569.95



Product Features

- 8
OPEN
SIDES
- 17
INCHES
TALL
- 20+
YEARS
DESIGN LIFE
- 120
MINUTES TO
ASSEMBLE
- 100%
RECYCLABLE
METAL

Configurations

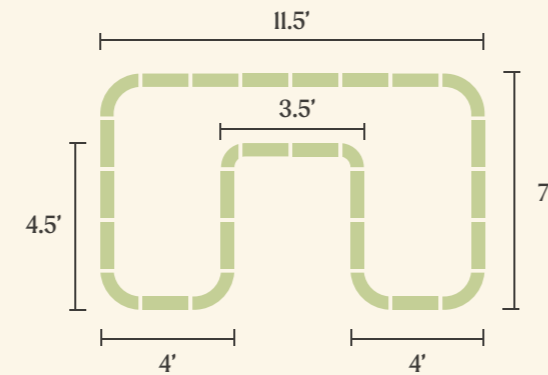

U-Shaped Jumbo

W x L x H: 7' x 11.5' x 17"

Grow Area (sq ft): 64.75

Cubic Feet: 92

Cubic Yard: 3.4



Model No.
VBUJB17W



17" Tall U- Jumbo Size-Olive Green Shaped Raised Garden Bed Kit

Our U-Shaped design offers a convenient wrap-around configuration, giving you easy access to more growing space for your fresh vegetables, herbs and flowers.

MSRP: \$569.95



Product Features

- 8
OPEN
SIDES
- 17
INCHES
TALL
- 20+
YEARS
DESIGN LIFE
- 120
MINUTES TO
ASSEMBLE
- 100%
RECYCLABLE
METAL

Configurations

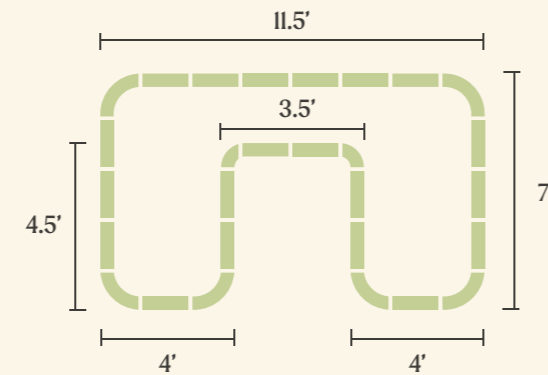

U-Shaped Jumbo

W x L x H: 7' x 11.5' x 17"

Grow Area (sq ft): 64.75

Cubic Feet: 92

Cubic Yard: 3.4

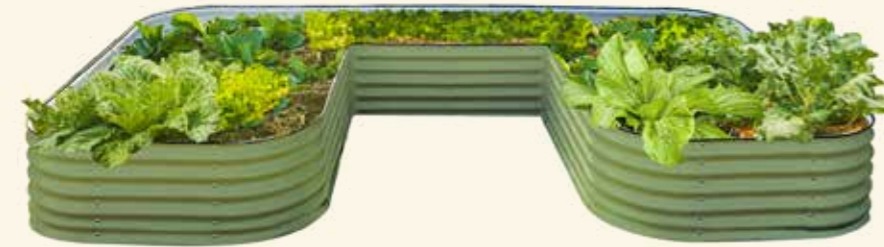

Model No.
VBUJB17G



17" Tall U- Jumbo Size-British Green Shaped Raised Garden Bed Kit

Our U-Shaped design offers a convenient wrap-around configuration, giving you easy access to more growing space for your fresh vegetables, herbs and flowers.

MSRP: \$569.95



Product Features

- 8
OPEN
SIDES
- 17
INCHES
TALL
- 20+
YEARS
DESIGN LIFE
- 120
MINUTES TO
ASSEMBLE
- 100%
RECYCLABLE
METAL

Configurations

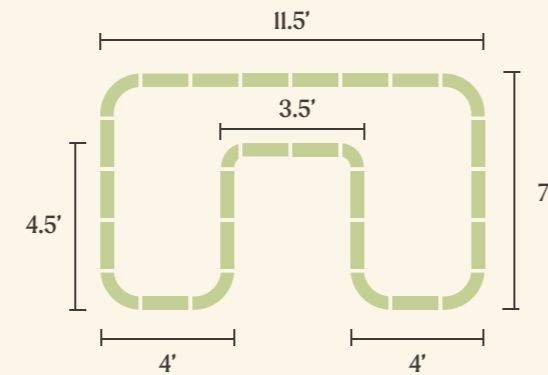

U-Shaped Jumbo

W x L x H: 7' x 11.5' x 17"
 Grow Area (sq ft): 64.75
 Cubic Feet: 92
 Cubic Yard: 3.4



Model No.
VBUJB17BG



17" Tall U- Jumbo Size-Modern Gray Shaped Raised Garden Bed Kit

Our U-Shaped design offers a convenient wrap-around configuration, giving you easy access to more growing space for your fresh vegetables, herbs and flowers.

MSRP: \$569.95



Product Features

- 8
OPEN
SIDES
- 17
INCHES
TALL
- 20+
YEARS
DESIGN LIFE
- 120
MINUTES TO
ASSEMBLE
- 100%
RECYCLABLE
METAL

Configurations

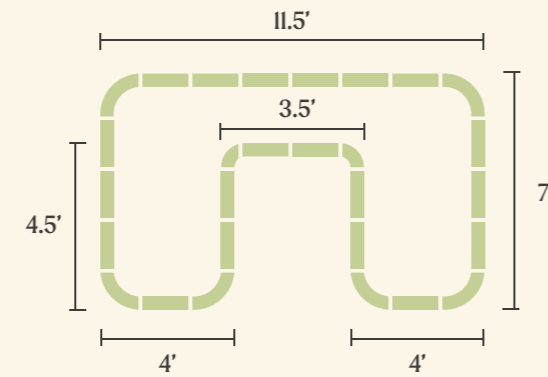

U-Shaped Jumbo

W x L x H: 7' x 11.5' x 17"

Grow Area (sq ft): 64.75

Cubic Feet: 92

Cubic Yard: 3.4



Model No.
VBUJB17MG



Cascading Metal Raised Garden Bed Kit - Standard Size - Pearl White

Named for the graceful tumbling of a waterfall, our Cascading Bed is a tiered raised garden bed that offers two heights in one. We designed this garden bed to offer an elegant configuration that combines the functions of our 17" and 32" Series, all in one compact 3.5ft x 3.5ft footprint. You can grow your deep-rooting plants in the taller section, and plants which require less depth in the front. The Cascading Bed is also well suited for displaying beautiful trailing plants, as the shape of the bed will allow plants to spill safely over the edge. The tiered design lends itself well to placement in an entryway, to warmly welcome guests through your front door or garden gate.

MSRP: \$239.95



Product Features

- 2
TIER
GARDENING
- 32
INCHES
TALL
- 20+
YEARS
DESIGN LIFE
- 120
MINUTES TO
ASSEMBLE
- 100%
RECYCLABLE
METAL

Configurations

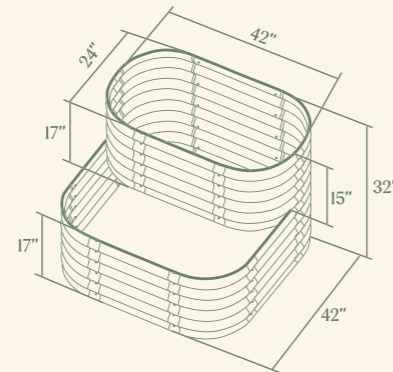

Cascading

Item Dimensions: 42"L x 42"W x 32"H

Top Part Dimensions: 42"L x 24"W x 17"H

Volume: 26 cubic ft



Model No.
VBCA3535W



Cascading Metal Raised Garden Bed Kit - Standard Size - Olive Green

Named for the graceful tumbling of a waterfall, our Cascading Bed is a tiered raised garden bed that offers two heights in one. We designed this garden bed to offer an elegant configuration that combines the functions of our 17" and 32" Series, all in one compact 3.5ft x 3.5ft footprint. You can grow your deep-rooting plants in the taller section, and plants which require less depth in the front. The Cascading Bed is also well suited for displaying beautiful trailing plants, as the shape of the bed will allow plants to spill safely over the edge. The tiered design lends itself well to placement in an entryway, to warmly welcome guests through your front door or garden gate.

MSRP: \$239.95



Product Features

- 2
TIER
GARDENING
- 32
INCHES
TALL
- 20+
YEARS
DESIGN LIFE
- 120
MINUTES TO
ASSEMBLE
- 100%
RECYCLABLE
METAL

Configurations

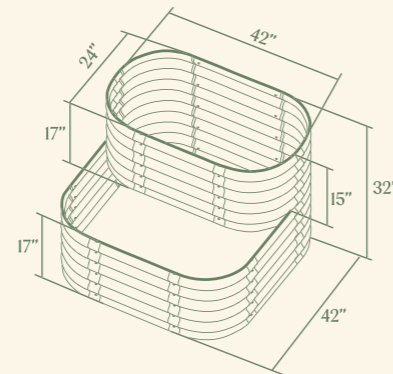

Cascading

Item Dimensions: 42" L x 42" W x 32" H

Top Part Dimensions: 42" L x 24" W x 17" H

Volume: 26 cubic ft



Model No.
VBCA3535G



Cascading Metal Raised Garden Bed Kit - Standard Size - British Green

Named for the graceful tumbling of a waterfall, our Cascading Bed is a tiered raised garden bed that offers two heights in one. We designed this garden bed to offer an elegant configuration that combines the functions of our 17" and 32" Series, all in one compact 3.5ft x 3.5ft footprint. You can grow your deep-rooting plants in the taller section, and plants which require less depth in the front. The Cascading Bed is also well suited for displaying beautiful trailing plants, as the shape of the bed will allow plants to spill safely over the edge. The tiered design lends itself well to placement in an entryway, to warmly welcome guests through your front door or garden gate.

MSRP: \$239.95



Product Features

- 2
TIER
GARDENING
- 32
INCHES
TALL
- 20+
YEARS
DESIGN LIFE
- 120
MINUTES TO
ASSEMBLE
- 100%
RECYCLABLE
METAL

Configurations

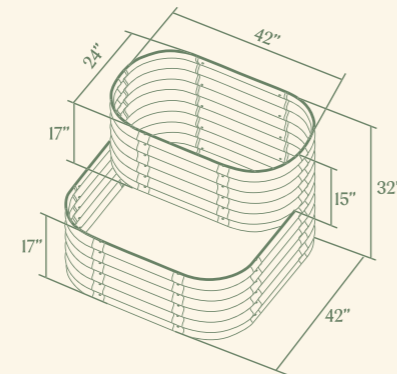

Cascading

Item Dimensions: 42"L x 42"W x 32"H

Top Part Dimensions: 42"L x 24"W x 17"H

Volume: 26 cubic ft



Model No.
VBCA3535BG



Cascading Metal Raised Garden Bed Kit - Standard Size-Modern Gray

Named for the graceful tumbling of a waterfall, our Cascading Bed is a tiered raised garden bed that offers two heights in one. We designed this garden bed to offer an elegant configuration that combines the functions of our 17" and 32" Series, all in one compact 3.5ft x 3.5ft footprint. You can grow your deep-rooting plants in the taller section, and plants which require less depth in the front. The Cascading Bed is also well suited for displaying beautiful trailing plants, as the shape of the bed will allow plants to spill safely over the edge. The tiered design lends itself well to placement in an entryway, to warmly welcome guests through your front door or garden gate.

MSRP: \$239.95



Product Features

2 TIER GARDENING	32 INCHES TALL	20+ YEARS DESIGN LIFE	120 MINUTES TO ASSEMBLE	100% RECYCLABLE METAL
------------------------	----------------------	-----------------------------	-------------------------------	-----------------------------

Configurations

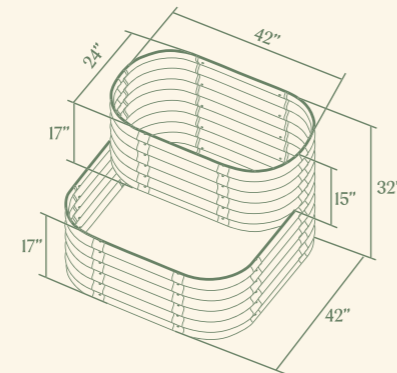

Cascading

Item Dimensions: 42" L x 42" W x 32" H

Top Part Dimensions: 42" L x 24" W x 17" H

Volume: 26 cubic ft



Model No.
VBCA3535BG





Small Shapes & Parts

Tree Surround & Watering Ring Kit- Pearl White

Give your trees room to grow with Vego Garden's Tree Surround & Watering Ring Kit! Using a tree surround raises the plant, allowing you to easily control the soil that your tree will thrive in, as well as neatly contain mulch, and protect your tree from moisture loss, flooding, & damage from lawn equipment.

Paired with the heavy-duty 16 gallon slow release watering ring, your trees will be set to thrive for years to come! Vego's tree watering bags are donut-shaped to easily fit around the trunk of your tree, and neatly into the Tree Surround. Placed under or over mulch, these UV-resistant watering bags provide slow-release irrigation to the roots of your tree, reducing shock and stress.

Tree Surround: 36 Inches Wide, 8 Inches Tall
Watering Ring: 36 Inches Wide, 16 Gallon, 12 Hours Slow Drip Irrigation



MSRP: \$69.95



Model No.
VRB3608W+WR



Tree Surround & Watering Ring Kit- Olive Green

Give your trees room to grow with Vego Garden's Tree Surround & Watering Ring Kit! Using a tree surround raises the plant, allowing you to easily control the soil that your tree will thrive in, as well as neatly contain mulch, and protect your tree from moisture loss, flooding, & damage from lawn equipment.

Paired with the heavy-duty 16 gallon slow release watering ring, your trees will be set to thrive for years to come! Vego's tree watering bags are donut-shaped to easily fit around the trunk of your tree, and neatly into the Tree Surround. Placed under or over mulch, these UV-resistant watering bags provide slow-release irrigation to the roots of your tree, reducing shock and stress.

Tree Surround: 36 Inches Wide, 8 Inches Tall
Watering Ring: 36 Inches Wide, 16 Gallon, 12 Hours Slow Drip Irrigation



MSRP: \$69.95



Model No.
VRB3608G+WR





Model No.
VBKID17W

17" Tall Kids First Garden Bed 42" x 24" - Pearl White

As a family with young children, we want to encourage them to spend more time in the garden and learn more about nature. This is how we came up with the idea of the Kids First Garden Bed. The kids garden bed measures 17" tall, 2 ft. x 3.5 ft. Despite its name, this kid's garden bed can actually grow a lot of vegetables. You can easily fit 6 tomato plants in the summer, or 16 carrot plants in the fall. You can also use it as an Herb Garden to grow mint, basil and rosemary!

MSRP: \$119.95



Product Features

- 1
KID-FRIENDLY
BED
- 32
INCHES
TALL
- 20+
YEARS
DESIGN LIFE
- 30
MINUTES TO
ASSEMBLE
- 100%
RECYCLABLE
METAL





Model No.
VBKID17G

17" Tall Kids First Garden Bed 42" x 24" - Olive Green

As a family with young children, we want to encourage them to spend more time in the garden and learn more about nature. This is how we came up with the idea of the Kids First Garden Bed. The kids garden bed measures 17" tall, 2 ft. x 3.5 ft. Despite its name, this kid's garden bed can actually grow a lot of vegetables. You can easily fit 6 tomato plants in the summer, or 16 carrot plants in the fall. You can also use it as an Herb Garden to grow mint, basil and rosemary!

MSRP: \$119.95



Product Features

- 1
KID-FRIENDLY
BED
- 32
INCHES
TALL
- 20+
YEARS
DESIGN LIFE
- 30
MINUTES TO
ASSEMBLE
- 100%
RECYCLABLE
METAL





Model No.
VBKID17BG

17" Tall Kids First Garden Bed 42" x 24" - British Green

As a family with young children, we want to encourage them to spend more time in the garden and learn more about nature. This is how we came up with the idea of the Kids First Garden Bed. The kids garden bed measures 17" tall, 2 ft. x 3.5 ft. Despite its name, this kid's garden bed can actually grow a lot of vegetables. You can easily fit 6 tomato plants in the summer, or 16 carrot plants in the fall. You can also use it as an Herb Garden to grow mint, basil and rosemary!

MSRP: \$119.95



Product Features

- 1
KID-FRIENDLY
BED
- 32
INCHES
TALL
- 20+
YEARS
DESIGN LIFE
- 30
MINUTES TO
ASSEMBLE
- 100%
RECYCLABLE
METAL





Model No.
VBKID17MG

17" Tall Kids First Garden Bed 42" x 24" - Modern Gray

As a family with young children, we want to encourage them to spend more time in the garden and learn more about nature. This is how we came up with the idea of the Kids First Garden Bed. The kids garden bed measures 17" tall, 2 ft. x 3.5 ft. Despite its name, this kid's garden bed can actually grow a lot of vegetables. You can easily fit 6 tomato plants in the summer, or 16 carrot plants in the fall. You can also use it as an Herb Garden to grow mint, basil and rosemary!

MSRP: \$119.95



Product Features

- 1
KID-FRIENDLY
BED
- 32
INCHES
TALL
- 20+
YEARS
DESIGN LIFE
- 30
MINUTES TO
ASSEMBLE
- 100%
RECYCLABLE
METAL



17" Tall Herb Garden Bed 24" Wide - Twin Pack - Pearl White

The Herb Garden twin pack is a set of two cute oval shaped metal beds. These compact garden beds are perfect for herbs, or small fruit trees.

MSRP: \$179.95



Product Features

2 SUPER COMPACT BEDS | 17 INCHES TALL | 20+ YEARS DESIGN LIFE | 30 MINUTES TO ASSEMBLE | 100% RECYCLABLE METAL

Configurations

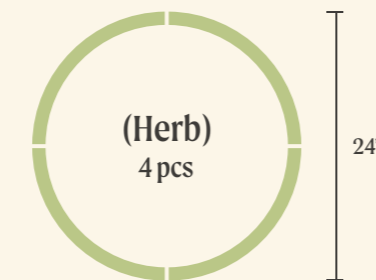

Herb
 Diameter(in): 24"
 Height(in): 17"
 Thickness: 0.6mm
 Volume: 4.5cu ft each



Model No. **VBHRB17W2**

17" Tall Herb Garden Bed 24" Wide - Twin Pack - Olive Green

The Herb Garden twin pack is a set of two cute oval shaped metal beds. These compact garden beds are perfect for herbs, or small fruit trees.

MSRP: \$179.95



Product Features

2 SUPER COMPACT BEDS | 17 INCHES TALL | 20+ YEARS DESIGN LIFE | 30 MINUTES TO ASSEMBLE | 100% RECYCLABLE METAL

Configurations

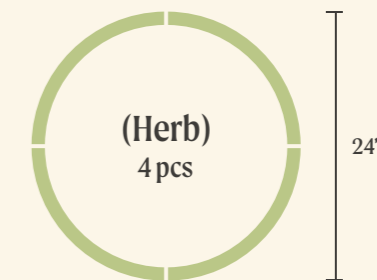

Herb
 Diameter(in): 24"
 Height(in): 17"
 Thickness: 0.6mm
 Volume: 4.5cu ft each



Model No. **VBHRB17G2**

17" Tall Herb Garden Bed 24" Wide - Twin Pack - British Green

The Herb Garden twin pack is a set of two cute oval shaped metal beds. These compact garden beds are perfect for herbs, or small fruit trees.

MSRP: \$179.95



Product Features

2 SUPER COMPACT BEDS	17 INCHES TALL	20+ YEARS DESIGN LIFE	30 MINUTES TO ASSEMBLE	100% RECYCLABLE METAL
----------------------------	----------------------	-----------------------------	------------------------------	-----------------------------

Configurations

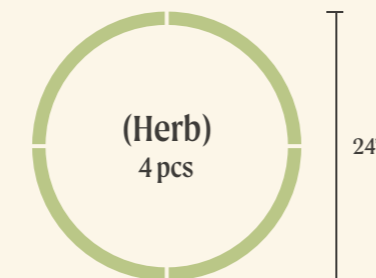

Herb
Diameter(in): 24"
Height(in): 17"
Thickness: 0.6mm
Volume: 4.5cu ft each



Model No.
VBHRB17BW2

17" Tall Herb Garden Bed 24" Wide - Twin Pack - Modern Gray

The Herb Garden twin pack is a set of two cute oval shaped metal beds. These compact garden beds are perfect for herbs, or small fruit trees.

MSRP: \$179.95



Product Features

2 SUPER COMPACT BEDS	17 INCHES TALL	20+ YEARS DESIGN LIFE	30 MINUTES TO ASSEMBLE	100% RECYCLABLE METAL
----------------------------	----------------------	-----------------------------	------------------------------	-----------------------------

Configurations

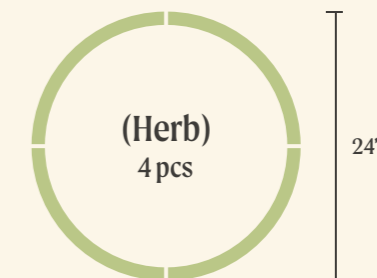

Herb
Diameter(in): 24"
Height(in): 17"
Thickness: 0.6mm
Volume: 4.5cu ft each



Model No.
VBHRB17MG2

17" Tall Berry Garden Bed 30" Wide - Twin Pack-Pearl White

The Berry Garden twin pack is a set of two cute rounded metal beds. These compact garden beds are perfect for berries, shrubs, or small fruit trees.

MSRP: \$199.95



Product Features

2 SUPER COMPACT BEDS		17 INCHES TALL		20+ YEARS DESIGN LIFE		30 MINUTES TO ASSEMBLE		100% RECYCLABLE METAL
----------------------------	--	----------------------	--	-----------------------------	--	------------------------------	--	-----------------------------

Configurations

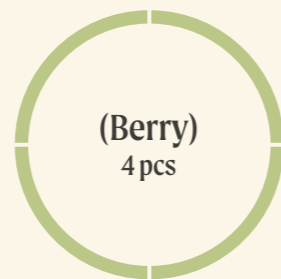

Berry
Diameter(in): 30"
Height(in): 17"
Thickness: 0.6mm
Volume: 7cu ft each



Model No.
VBBRY17W2

17" Tall Berry Garden Bed 30" Wide - Twin Pack-Olive Green

The Berry Garden twin pack is a set of two cute rounded metal beds. These compact garden beds are perfect for berries, shrubs, or small fruit trees.

MSRP: \$199.95



Product Features

2 SUPER COMPACT BEDS		17 INCHES TALL		20+ YEARS DESIGN LIFE		30 MINUTES TO ASSEMBLE		100% RECYCLABLE METAL
----------------------------	--	----------------------	--	-----------------------------	--	------------------------------	--	-----------------------------

Configurations



Berry
Diameter(in): 30"
Height(in): 17"
Thickness: 0.6mm
Volume: 7cu ft each



Model No.
VBBRY17G2

17" Tall Berry Garden Bed 30" Wide - Twin Pack - British Green

The Berry Garden twin pack is a set of two cute rounded metal beds. These compact garden beds are perfect for berries, shrubs, or small fruit trees.

MSRP: \$199.95



Product Features

2 SUPER COMPACT BEDS	17 INCHES TALL	20+ YEARS DESIGN LIFE	30 MINUTES TO ASSEMBLE	100% RECYCLABLE METAL
----------------------------	----------------------	-----------------------------	------------------------------	-----------------------------

Configurations

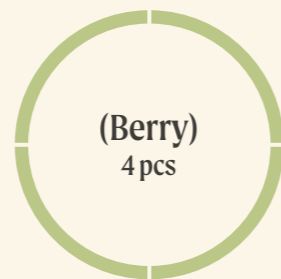

Berry
Diameter(in): 30"
Height(in): 17"
Thickness: 0.6mm
Volume: 7cu ft each



Model No.
VBBRY17BG2

17" Tall Berry Garden Bed 30" Wide - Twin Pack - Modern Gray

The Berry Garden twin pack is a set of two cute rounded metal beds. These compact garden beds are perfect for berries, shrubs, or small fruit trees.

MSRP: \$199.95



Product Features

2 SUPER COMPACT BEDS	17 INCHES TALL	20+ YEARS DESIGN LIFE	30 MINUTES TO ASSEMBLE	100% RECYCLABLE METAL
----------------------------	----------------------	-----------------------------	------------------------------	-----------------------------

Configurations



Berry
Diameter(in): 30"
Height(in): 17"
Thickness: 0.6mm
Volume: 7cu ft each



Model No.
VBBRY17MG2

Bracing Rods - Twin Pack

Bracing rods are designed for reinforcement of extra long Vego Garden raised beds. Made from aluminum, the rods are strong but lightweight. The metal bracing rods feature an internally threaded design, and can be installed easily with the same bolt and washers included in the raised bed package. The rods will not be visible from the outside once garden is filled with soil. We include bracing rods in all our garden bed kits large enough to require them, so there is no need to purchase additional rods. To build a longer garden bed than standard size, please purchase our Extension Kit which includes both extra panels and bracing rods. Each Twin Pack includes a qty of 2 rods.
Each Twin Pack has 2 qty of rods included.

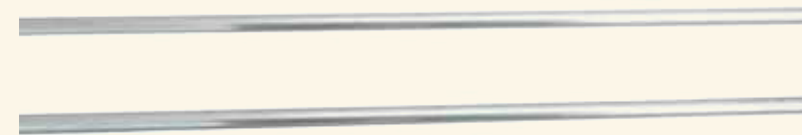

MSRP

Model No	Size
BR20T	2.0'
BR25T	2.5'
BR35T	3.5'
BR40T	4.0'
BR45T	4.5'
BR50T	5.0'





Advanced Beds

Self-Watering Garden Bed-Pearl White

Experience hassle-free gardening with Vego Garden's Self Watering Garden Bed! This raised garden bed is designed with an innovative wicking cell system that closes the bottom of the bed, providing just the right amount of moisture for your plants to thrive. The 3.5" tall wicking cell serves as a reservoir, collecting excess water and redistributing it to your plants over time, so you don't have to water as often. It is also designed with air pruning strips so that your plants' roots air prune and don't get oversaturated. Available in three sizes - 2x4, 2x6, and 2x8 - the Self Watering Garden Bed is easy to assemble and suits any outdoor space. Plus, with the wicking cells serving as the bed's bottom, it can be placed on a patio or balcony instead of soil. Get ready to grow your own garden with Vego Garden's Self Watering Garden Bed!



MSRP



Model No	Dimension
VSWB2040W	2 X 4ft
VSWB2060W	2 X 6ft
VSWB2080W	2 X 8ft

Configurations



Wicking Cell

Closing the bottom of the bed there is a 3.5" tall, self-watering, wicking cell. A wicking cell is a reservoir which collects excess water, and redistributes it to your plants over time, meaning you have to water less often.

Self-Watering Garden Bed-Olive Green

Experience hassle-free gardening with Vego Garden's Self Watering Garden Bed! This raised garden bed is designed with an innovative wicking cell system that closes the bottom of the bed, providing just the right amount of moisture for your plants to thrive. The 3.5" tall wicking cell serves as a reservoir, collecting excess water and redistributing it to your plants over time, so you don't have to water as often. It is also designed with air pruning strips so that your plants' roots air prune and don't get oversaturated. Available in three sizes - 2x4, 2x6, and 2x8 - the Self Watering Garden Bed is easy to assemble and suits any outdoor space. Plus, with the wicking cells serving as the bed's bottom, it can be placed on a patio or balcony instead of soil. Get ready to grow your own garden with Vego Garden's Self Watering Garden Bed!



MSRP



Model No	Dimension
VSWB2040G	2 X 4ft
VSWB2060G	2 X 6ft
VSWB2080G	2 X 8ft

Configurations



Wicking Cell

Closing the bottom of the bed there is a 3.5" tall, self-watering, wicking cell. A wicking cell is a reservoir which collects excess water, and redistributes it to your plants over time, meaning you have to water less often.

Self-Watering Garden Bed-British Green

Experience hassle-free gardening with Vego Garden's Self Watering Garden Bed! This raised garden bed is designed with an innovative wicking cell system that closes the bottom of the bed, providing just the right amount of moisture for your plants to thrive. The 3.5" tall wicking cell serves as a reservoir, collecting excess water and redistributing it to your plants over time, so you don't have to water as often. It is also designed with air pruning strips so that your plants' roots air prune and don't get oversaturated. Available in three sizes - 2x4, 2x6, and 2x8 - the Self Watering Garden Bed is easy to assemble and suits any outdoor space. Plus, with the wicking cells serving as the bed's bottom, it can be placed on a patio or balcony instead of soil. Get ready to grow your own garden with Vego Garden's Self Watering Garden Bed!



MSRP



Model No	Dimension
VSWB2040BG	2 X 4ft
VSWB2060BG	2 X 6ft
VSWB2080BG	2 X 8ft

Configurations



Wicking Cell

Closing the bottom of the bed there is a 3.5" tall, self-watering, wicking cell. A wicking cell is a reservoir which collects excess water, and redistributes it to your plants over time, meaning you have to water less often.

Self-Watering Garden Bed-Modern Gray

Experience hassle-free gardening with Vego Garden's Self Watering Garden Bed! This raised garden bed is designed with an innovative wicking cell system that closes the bottom of the bed, providing just the right amount of moisture for your plants to thrive. The 3.5" tall wicking cell serves as a reservoir, collecting excess water and redistributing it to your plants over time, so you don't have to water as often. It is also designed with air pruning strips so that your plants' roots air prune and don't get oversaturated. Available in three sizes - 2x4, 2x6, and 2x8 - the Self Watering Garden Bed is easy to assemble and suits any outdoor space. Plus, with the wicking cells serving as the bed's bottom, it can be placed on a patio or balcony instead of soil. Get ready to grow your own garden with Vego Garden's Self Watering Garden Bed!



MSRP



Model No	Dimension
VSWB2040MG	2 X 4ft
VSWB2060MG	2 X 6ft
VSWB2080MG	2 X 8ft

Configurations



Wicking Cell

Closing the bottom of the bed there is a 3.5" tall, self-watering, wicking cell. A wicking cell is a reservoir which collects excess water, and redistributes it to your plants over time, meaning you have to water less often.

Self-Watering Planter - Twin Pack- Pearl White



Experience hassle-free gardening with Vego Garden's Self Watering Planter! This raised garden bed is designed with an innovative wicking cell system that closes the bottom of the bed, providing just the right amount of moisture for your plants to thrive. The 3.5" tall wicking cell serves as a reservoir, collecting excess water and redistributing it to your plants over time, so you don't have to water as often. It is also designed with air pruning strips so that your plants' roots air prune and don't get oversaturated. The 2x2 ft Self Watering Planter is easy to assemble and suits any outdoor space. Plus, with the wicking cells serving as the bed's bottom, it can be placed on a patio or balcony instead of soil.

MSRP: \$249.95



Model No.
VSWB2020TW



Configurations



Wicking Cell

Closing the bottom of the bed there is a 3.5" tall, self-watering, wicking cell. A wicking cell is a reservoir which collects excess water, and redistributes it to your plants over time, meaning you have to water less often.

Self-Watering Planter - Twin Pack- Olive Green



Experience hassle-free gardening with Vego Garden's Self Watering Planter! This raised garden bed is designed with an innovative wicking cell system that closes the bottom of the bed, providing just the right amount of moisture for your plants to thrive. The 3.5" tall wicking cell serves as a reservoir, collecting excess water and redistributing it to your plants over time, so you don't have to water as often. It is also designed with air pruning strips so that your plants' roots air prune and don't get oversaturated. The 2x2 ft Self Watering Planter is easy to assemble and suits any outdoor space. Plus, with the wicking cells serving as the bed's bottom, it can be placed on a patio or balcony instead of soil.

MSRP: \$249.95



Model No.
VSWB2020TG



Configurations



Wicking Cell

Closing the bottom of the bed there is a 3.5" tall, self-watering, wicking cell. A wicking cell is a reservoir which collects excess water, and redistributes it to your plants over time, meaning you have to water less often.

Self-Watering Planter - Twin Pack- British Green



Experience hassle-free gardening with Vego Garden's Self Watering Planter! This raised garden bed is designed with an innovative wicking cell system that closes the bottom of the bed, providing just the right amount of moisture for your plants to thrive. The 3.5" tall wicking cell serves as a reservoir, collecting excess water and redistributing it to your plants over time, so you don't have to water as often. It is also designed with air pruning strips so that your plants' roots air prune and don't get oversaturated. The 2x2 ft Self Watering Planter is easy to assemble and suits any outdoor space. Plus, with the wicking cells serving as the bed's bottom, it can be placed on a patio or balcony instead of soil.

MSRP: \$249.95



Model No.
VSWB2020TBG



Configurations



Wicking Cell

Closing the bottom of the bed there is a 3.5" tall, self-watering, wicking cell. A wicking cell is a reservoir which collects excess water, and redistributes it to your plants over time, meaning you have to water less often.

Self-Watering Planter - Twin Pack- Modern Gray



Experience hassle-free gardening with Vego Garden's Self Watering Planter! This raised garden bed is designed with an innovative wicking cell system that closes the bottom of the bed, providing just the right amount of moisture for your plants to thrive. The 3.5" tall wicking cell serves as a reservoir, collecting excess water and redistributing it to your plants over time, so you don't have to water as often. It is also designed with air pruning strips so that your plants' roots air prune and don't get oversaturated. The 2x2 ft Self Watering Planter is easy to assemble and suits any outdoor space. Plus, with the wicking cells serving as the bed's bottom, it can be placed on a patio or balcony instead of soil.

MSRP: \$249.95



Model No.
VSWB2020TMG



Configurations



Wicking Cell

Closing the bottom of the bed there is a 3.5" tall, self-watering, wicking cell. A wicking cell is a reservoir which collects excess water, and redistributes it to your plants over time, meaning you have to water less often.



Elevated Rolling Garden Bed-Pearl White

Standing 39" tall our Elevated Rolling Garden Beds are perfect for your patio or balcony. They feature 4 heavy duty, locking wheels, a shelf underneath to store your gardening essentials, and a handle on each end for easy rolling. This is a great option for apartments or small homes, and offers an inventive way to transport delicate plants inside easily.

*Note: Cover System is sold separately

MSRP



Model No	Dimension
VEB2040W	2 X 4ft
VEB2060W	2 X 6ft

Configurations



Elevated Rolling Garden Bed-Olive Green

Standing 39" tall our Elevated Rolling Garden Beds are perfect for your patio or balcony. They feature 4 heavy duty, locking wheels, a shelf underneath to store your gardening essentials, and a handle on each end for easy rolling. This is a great option for apartments or small homes, and offers an inventive way to transport delicate plants inside easily.

*Note: Cover System is sold separately

MSRP



Model No	Dimension
VEB2040G	2 X 4ft
VEB2060G	2 X 6ft

Configurations





Elevated Rolling Garden Bed - British Green

Standing 39" tall our Elevated Rolling Garden Beds are perfect for your patio or balcony. They feature 4 heavy duty, locking wheels, a shelf underneath to store your gardening essentials, and a handle on each end for easy rolling. This is a great option for apartments or small homes, and offers an inventive way to transport delicate plants inside easily.

*Note: Cover System is sold separately

MSRP



Model No	Dimension
VEB2040BG	2 X 4ft
VEB2060BG	2 X 6ft

Configurations



Elevated Rolling Garden Bed - Modern Gray

Standing 39" tall our Elevated Rolling Garden Beds are perfect for your patio or balcony. They feature 4 heavy duty, locking wheels, a shelf underneath to store your gardening essentials, and a handle on each end for easy rolling. This is a great option for apartments or small homes, and offers an inventive way to transport delicate plants inside easily.

*Note: Cover System is sold separately

MSRP



Model No	Dimension
VEB2040MG	2 X 4ft
VEB2060MG	2 X 6ft

Configurations





Model No.
VGFP RB20W

Dragon Fruit Rolling Planter-Pearl White

The dragon fruit plant is actually a cactus, and requires a specialized trellis to support its water-filled branches. We combined our Rolling Planter with some innovative new tools to create a Dragon Fruit Planter, which makes it easy to grow dragon fruit at home! The wicking cell enclosed in the bottom helps regulate and conserve water, & the heavy duty locking wheels make it easy to roll your frost-sensitive cactus inside during colder months.

MSRP: \$259.95



Dimensions

Total height: 5ft. tall from wheels to top of trellis

Garden bed measures 17" tall, has a diameter of 24", and the wheels measure about 7" tall

Interior depth measures 13.5" due to the 3.5" wicking cell which closes the bottom of the bed





Model No.
VGFPRB20G

Dragon Fruit Rolling Planter-Olive Green

The dragon fruit plant is actually a cactus, and requires a specialized trellis to support its water-filled branches. We combined our Rolling Planter with some innovative new tools to create a Dragon Fruit Planter, which makes it easy to grow dragon fruit at home! The wicking cell enclosed in the bottom helps regulate and conserve water, & the heavy duty locking wheels make it easy to roll your frost-sensitive cactus inside during colder months.

MSRP: \$259.95



Dimensions

Total height: 5ft. tall from wheels to top of trellis

Garden bed measures 17" tall, has a diameter of 24", and the wheels measure about 7" tall

Interior depth measures 13.5" due to the 3.5" wicking cell which closes the bottom of the bed





Model No.
VGFPRB20BG

Dragon Fruit Rolling Planter-British Green

The dragon fruit plant is actually a cactus, and requires a specialized trellis to support its water-filled branches. We combined our Rolling Planter with some innovative new tools to create a Dragon Fruit Planter, which makes it easy to grow dragon fruit at home! The wicking cell enclosed in the bottom helps regulate and conserve water, & the heavy duty locking wheels make it easy to roll your frost-sensitive cactus inside during colder months.

MSRP: \$259.95



Dimensions

Total height: 5ft. tall from wheels to top of trellis

Garden bed measures 17" tall, has a diameter of 24", and the wheels measure about 7" tall

Interior depth measures 13.5" due to the 3.5" wicking cell which closes the bottom of the bed





Model No.
VGFPRB20MG

Dragon Fruit Rolling Planter-Modern Gray

The dragon fruit plant is actually a cactus, and requires a specialized trellis to support its water-filled branches. We combined our Rolling Planter with some innovative new tools to create a Dragon Fruit Planter, which makes it easy to grow dragon fruit at home! The wicking cell enclosed in the bottom helps regulate and conserve water, & the heavy duty locking wheels make it easy to roll your frost-sensitive cactus inside during colder months.

MSRP: \$259.95



Dimensions

Total height: 5ft. tall from wheels to top of trellis

Garden bed measures 17" tall, has a diameter of 24", and the wheels measure about 7" tall

Interior depth measures 13.5" due to the 3.5" wicking cell which closes the bottom of the bed





Model No.
VRPRB20TW

Rolling Planter - Twin Pack-Pearl White

This 2ft by 2ft rounded square rolling planter might be small, but it's mighty! Perfect for your patio, and easy to roll inside during frosty seasons, our rolling planters feature heavy duty locking wheels, super sturdy frames, and wicking cells for easy watering. Some might say they're overbuilt, but we prefer to think of them as built to last a lifetime.

Note: Twin packs are sold with two rolling planters per box

MSRP: \$299.95



Dimensions

Total height: 24" tall from wheels to top edge

Garden bed measures 17" tall, and wheels measure about 7" tall

Interior depth measures 13.5" due to the 3.5" wicking cell which closes the bottom of the bed





Model No.
VRPRB20TG

Rolling Planter - Twin Pack-Pearl White

This 2ft by 2ft rounded square rolling planter might be small, but it's mighty! Perfect for your patio, and easy to roll inside during frosty seasons, our rolling planters feature heavy duty locking wheels, super sturdy frames, and wicking cells for easy watering. Some might say they're overbuilt, but we prefer to think of them as built to last a lifetime.

Note: Twin packs are sold with two rolling planters per box

MSRP: \$299.95



Dimensions

Total height: 24" tall from wheels to top edge

Garden bed measures 17" tall, and wheels measure about 7" tall

Interior depth measures 13.5" due to the 3.5" wicking cell which closes the bottom of the bed





Model No.
VRPRB20TBG

Rolling Planter - Twin Pack-British Gray

This 2ft by 2ft rounded square rolling planter might be small, but it's mighty! Perfect for your patio, and easy to roll inside during frosty seasons, our rolling planters feature heavy duty locking wheels, super sturdy frames, and wicking cells for easy watering. Some might say they're overbuilt, but we prefer to think of them as built to last a lifetime.

Note: Twin packs are sold with two rolling planters per box

MSRP: \$299.95



Dimensions

Total height: 24" tall from wheels to top edge

Garden bed measures 17" tall, and wheels measure about 7" tall

Interior depth measures 13.5" due to the 3.5" wicking cell which closes the bottom of the bed





Model No.
VRPRB20TMG

Rolling Planter - Twin Pack-Modern Gray

This 2ft by 2ft rounded square rolling planter might be small, but it's mighty! Perfect for your patio, and easy to roll inside during frosty seasons, our rolling planters feature heavy duty locking wheels, super sturdy frames, and wicking cells for easy watering. Some might say they're overbuilt, but we prefer to think of them as built to last a lifetime.

Note: Twin packs are sold with two rolling planters per box

MSRP: \$299.95



Dimensions

Total height: 24" tall from wheels to top edge

Garden bed measures 17" tall, and wheels measure about 7" tall

Interior depth measures 13.5" due to the 3.5" wicking cell which closes the bottom of the bed





Add Ons

Solar Garden Light

Let your garden light the way with Vego's Solar Garden Lights! These waterproof, solar-charged lights are magnetic, and snap flush into the corrugated pattern of your garden bed. Simply turn on the light, magnet to your garden bed, and enjoy the ambiance of an evening stroll through your garden.

Note: To test the light, turn on & cover the solar panel with your hands, or hold it in the dark and it should illuminate. If it does not, let the light charge in full sun for 5-6 hours, then test again.

Model No	Size
VSGL-2	2 Pack
VSGL-4	4 Pack
VSGL-6	6 Pack
VSGL-8	8 Pack

Dimensions

Width: 4"

Length: 4.4"

Thickness: 3"

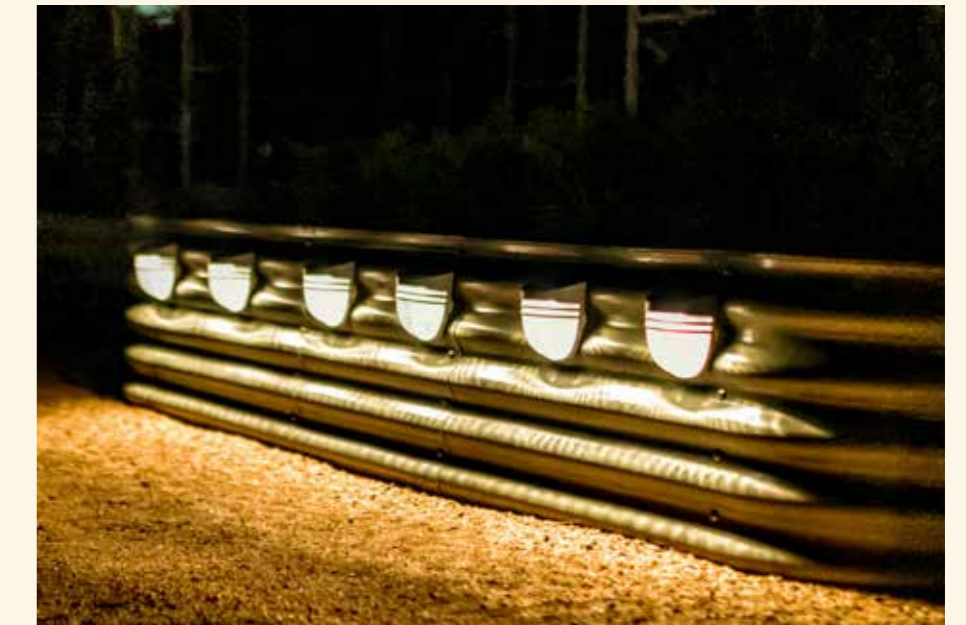



Model No.
VTB01

Garden Tool Box

Your garden set up just got more convenient. Introducing the Vego Garden Tool Box! This sturdy toolbox hangs securely from the edge of your garden bed, and its hinged lid means your tools are never out of reach! Drainage holes in the bottom extend the life of your tools by allowing them to dry after use.

MSRP: \$39.95

Dimensions

Length: 16 inches

Width: 7.5 inches

Height: 10 inches



Cover System & Mister Irrigation

Pests in your garden are now a thing of the past. Modularly designed, Vego Garden's Modular Cover System can be customized to match the configuration of any Vego Garden raised garden bed. The frame, which is made of durable powder coated steel, conveniently attaches to the garden bed's interior through the existing bolt holes for a secure, custom fit.

The top of the frame is gently arched, to allow a little extra height for your plants to thrive. While you can use the frame alone as a trellis, in addition to the frame, we've designed a series of covers, custom fit to the size and shape of the frame to protect your plants from the elements.

Included with the Cover System is Vego's state of the art Mister Irrigation System. Designed for easy installation with your Cover System and standard garden hose, the pre-cut irrigation tubes clip securely to the frame, and the mister nozzles can be adjusted to gently mist the plants inside.



Cover Model	Cover/Bed Dimension	Garden Bed Kit	Cover Height (")	Installed Height on 17"	Installed Height on 32" Model
VC2050	2.0' x 5.0'	4 In 1	36	53	68
VC3535	3.5' x 3.5'	4 In 1	36	53	68
VC2065	2.0' x 6.5'	6 In 1	36	53	68
VC3550	3.5' x 5.0'	6 In 1	36	53	68
VC2080	2.0' x 8.0'	9 In 1	36	53	68
VC3565	3.5' x 6.5'	9 In 1	36	53	68
VC2595	2.5' x 9.5'	10 In 1	38	55	70
VC4080	4.0 x 8.0'	10 In 1	38	55	70
VCRB35	3.5' Round	3.5' (42") Round	41	58	73
VCRB20T	2.0' Round	Herb Twin Pack	28	45	NA
VC2035	2.0' x 3.5'	Kids Garden	28	45	NA
VC2040	2.0' x 4.0'	Elevated	28	NA	NA
VC2060	2.0 x 6.0	Elevated	28	NA	NA





Arched Trellis System

Trellis: Corrosion resistant, powder coated metal.

Connectors: Injection molding Polypropylene (PP) Plastic.

Hardware: Grade 304 Stainless Steel hardware.



Configuration	VAT15	VAT20	VAT35	VAT45	VAT55	VAT60	VAT70
Section	Single	Single	Single	VAT45	VAT55	VAT60	VAT70
Trellis Length	1.5'	2.0'	3.5'	4.5'	5.5'	6.0'	1.0'
Bed W x L	2.0' x 3.5'	3.0'	2.0' x 5.0' 3.5' x 5.0'	2.0' x 6.5' 3.5' x 6.5'	4.0' x 8.0'	2.0' x 8.0'	2.5' x 9.5'





Wall Trellis System

Trellis: Corrosion resistant, powder coated metal.

Connectors: Injection molding Polypropylene (PP) Plastic.

Hardware: Grade 304 Stainless Steel hardware.



Configuration	VWTRB35	VWT35	VWT40	VWT50	VWT65	VWT2080	VWT4080	VWT95
Section	Triple	Triple	Triple	Triple	Five	Five	Five	Five
Trellis Length	3.5'	3.5'	4.0'	5.0'	6.5'	8.0'	8.0'	9.5'
Bed W x L	3.5' Round	2.0' x 3.5'	2.0' x 4.0'	2.0' x 5.0'	2.0' x 6.5'	2.0' x 8.0'	4.0' x 8.0'	2.5' x 9.5'



In-Ground Worm Composter

The Vego Garden In-Ground Worm Composter makes sustainable and efficient gardening a breeze by turning your organic waste into rich, nutrient-dense garden bed material. Simply dig a hole in the ground of your Vego Garden, bury the Worm Composting Bin, fill with organic waste and worms, and let nature do the work. It's that simple!

Note: worms are not included.

Model No	Set
VWC01LG	Single
VWC01LGTWN	Twin Pack

Configurations

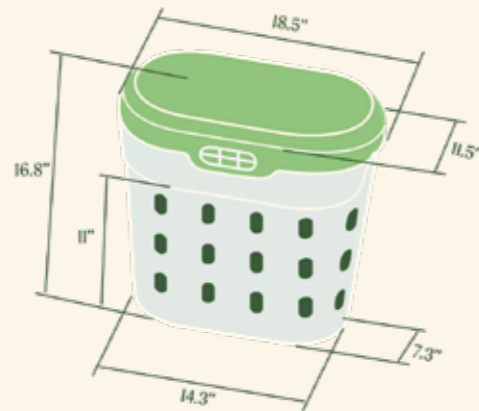

Materials & Dimensions

Injection Mold with durable, BPA-free Polypropylene Plastic (PP), specifically meant for outdoor use.
 Dimensions: 18.5"L x 11.5" W x 16.8"H
 Thickness: 3.0mm
 Volume: 5.0 Gallons (usable), 8.0 Gallons (total)



Wicking Cells

Experience hassle-free gardening with Vego Garden's Self Watering Planter! This raised garden bed is designed with an innovative wicking cell system that closes the bottom of the bed, providing just the right amount of moisture for your plants to thrive. The 3.5" tall wicking cell serves as a reservoir, collecting excess water and redistributing it to your plants over time, so you don't have to water as often. It is also designed with air pruning strips so that your plants' roots air prune and don't get oversaturated. The 2x2 ft Self Watering Planter is easy to assemble and suits any outdoor space. Plus, with the wicking cells serving as the bed's bottom, it can be placed on a patio or balcony instead of soil.

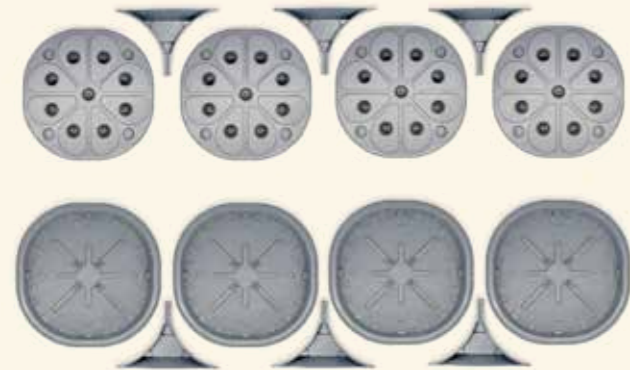

Model No	Dimensions
VSW2020T	2 x 2 ft Twin Pack (2 cells)
VSW2080T	2 x 8 ft (4 cells + 6 corners)

Configurations



Wicking Cell

Closing the bottom of the bed there is a 3.5" tall, self-watering, wicking cell. A wicking cell is a reservoir which collects excess water, and redistributes it to your plants over time, meaning you have to water less often.



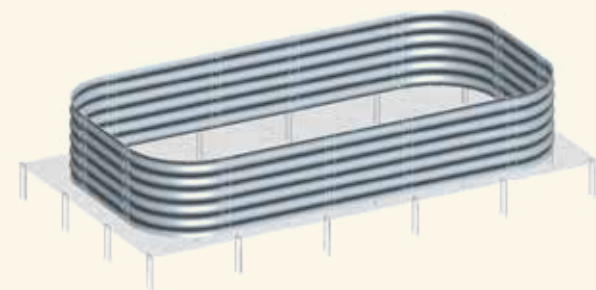

Stainless Steel Gopher Net

Free from harmful toxins and chemicals, our Gopher Net is a safe, cruelty-free way to prevent gophers and other burrowing visitors from entering your garden beds. Made from extra thick 304 grade stainless steel, the screen and staples are designed to be durable and last for decades under the soil, and are tailor-made to fit each of our popular configurations.

***Note: Gopher Nets are sold individually and do not include garden beds.**

Model No	Garden Bed Configuration	Gopher Net Size	Staple Qty
VGN2050	4.0' x 8.0'	4.5' x 8.5'	24
VGN2065	2.5' x 9.5'	3.0' x 10.0'	24
VGN2080	3.5' x 6.5'	4.0' x 7.0'	20
VGN2595	2.0' x 8.0'	2.5' x 8.5'	20
VGN3535	3.5' x 5.0'	4.0' x 5.5'	16
VGN3550	2.0' x 6.5'	2.5' x 7.0'	16
VGN3565	3.5' x 3.5'	4.0' x 4.0'	12
VGN4080	2.0' x 5.0'	2.5' x 5.5'	12





Seeding Trays

Standard Seedling Trays

Featuring eight spacious growing cells per tray, you can ensure great seed-starts and propagations with Vego Garden's innovative Seedling Trays!

With air-pruning strips along the sides of each cell, you can say goodbye to root binding and transplant shock for your seedlings; plus, each cell's individual draining hole allows for hassle-free plug extraction. Additionally, specialized drip-watering channels provide gentle hydration to the delicate seeds without upsetting their placement. Talk about the perfect way to set your seedlings up for success!

Note: lids sold separately

MSRP

Model No	VST8C-8	VST8C-16	VST8C-32	VST8C-64
Size	8 Pack	16 Pack	32 Pack	64 Pack

Dimensions

Top width: 5" x 5"

Bottom width: 4.75" x 4.75"

Cell depth: 2.75"

Individual cell width: 1" x 1"

8 trays fit neatly in a 1020 drip pan



Seed Starting Bundle - 10 in. x 10 in.

You can ensure great seed-starts and propagations with Vego Garden's innovative Seedling Suite products, and what better way to begin than with a bundle deal! Seedling bundles include everything you need to get your seedlings started, and can be customized to your needs.

Start with a 10 x 10 in bottom tray, and then select the Seedling Tray size you prefer - Standard or Jumbo! The bundle includes our specialty drip-irrigation lids for each tray.

MSRP

Model No	V1010BST	V1010BJB
Size	Standard	Jumbo

Dimensions

Bottom Tray:

10" x 10"

Seedling Trays:

Top width: 5" x 5"

Bottom width: 4.75" x 4.75"

Individual cell width: 1" x 1" or 2.5" x 2.5"

Lids

Length x Width: 5" x 5"

Height: 2.5"

Irrigation Chamber Depth: 2"



Seed Starting Bundle - 10 in. x 20 in.

You can ensure great seed-starts and propagations with Vego Garden's innovative Seedling Suite products, and what better way to begin than with a bundle deal! Seedling bundles include everything you need to get your seedlings started, and can be customized to your needs.

Start with a 10 x 20 in bottom tray, and then select the Seedling Tray size you prefer - all Standard size, all Jumbo size, or half and half! The bundle includes our specialty drip-irrigation lids for each tray.



MSRP

Model No	V1020BST	V1020BJB	V1020BMX
Size	Standard	Jumbo	Mix

Dimensions

Bottom Tray:

10" x 20"

Seedling Trays:

Top width: 5" x 5"

Bottom width: 4.75" x 4.75"

Individual cell width: 1" x 1" or 2.5" x 2.5"

Lids

Length x Width: 5" x 5"

Height: 2.5"

Irrigation Chamber Depth: 2"



Jumbo Seedling Trays

Featuring four extra-deep, jumbo growing cells per tray, you can ensure great seed-starts and propagations with Vego Garden's innovative Jumbo Seedling Trays! Perfect for larger plants like tomatoes, eggplants & more!

With air-pruning strips along the sides of each cell, you can say goodbye to root binding and transplant shock for your seedlings; plus, each cell's individual draining hole allows for hassle-free plug extraction. Additionally, specialized drip-watering channels provide gentle hydration to the delicate seeds without upsetting their placement. Talk about the perfect way to set your seedlings up for success!

Note: lids sold separately

MSRP

Model No	VST4C-8	VST4C-16	VST4C-32	VST4C-64
Size	8 Pack	16 Pack	32 Pack	64 Pack

Dimensions

Top width: 5" x 5"

Bottom width: 4.75" x 4.75"

Cell depth: 4"

Individual cell width: 2.5" x 2.5"

4 trays fit neatly in a 1010 bottom tray

8 trays fit neatly in a 1020 bottom tray



Seedling Tray Lids with Drip Irrigation

Featuring four extra-deep, jumbo growing cells per tray, you can ensure great seed-starts and propagations with Vego Garden's innovative Jumbo Seedling Trays! Perfect for larger plants like tomatoes, eggplants & more!

With air-pruning strips along the sides of each cell, you can say goodbye to root binding and transplant shock for your seedlings; plus, each cell's individual draining hole allows for hassle-free plug extraction. Additionally, specialized drip-watering channels provide gentle hydration to the delicate seeds without upsetting their placement. Talk about the perfect way to set your seedlings up for success!

Note: lids sold separately

MSRP

Model No	VSC0505-8	VSC0505-16	VSC0505-32	VSC0505-64
Size	8 Pack	16 Pack	32 Pack	64 Pack

Dimensions

Length x Width: 5" x 5"

Height: 2.5"

Irrigation Chamber Depth: 2"



Bottom Watering Trays

All the benefits of bottom watering without any of the mess! Vego Garden's Bottom Watering Trays are designed to pair perfectly with all our Seedling Suite products, featuring gentle ridges in the bottom to hold your Vego Seedling Trays securely in place.

The bottom trays are heavy duty and won't warp or crack in the elements, giving you years of use. Each tray is also shaped with two durable handles on each end, so you can easily and gently move your set up without disturbing your growing cells.

In two nursery standard sizes, 1010 and 1020, these leakproof bottom trays will coordinate neatly into your seed-starting set up. Talk about the perfect way to set your seedlings up for success!

Note: lids sold separately

MSRP

Dimensions

1010: 10" x 10" x 1"

1020: 10" x 20" x 1.5"



Model No	VSF1010-4	VSF1010-8	VSF1010-16	VSF1010-32	VSF1020-2	VSF1020-4	VSF1020-8	VSF1020-16
Size	10 in x 10 in	10 in x 10 in	10 in x 10 in	10 in x 10 in	10 in x 20 in	10 in x 20 in	10 in x 20 in	10 in x 20 in
Count	4 Pack	8 Pack	16 Pack	32 Pack	2 Pack	4 Pack	8 Pack	16Pack





Essentials



Organic Slow Release Fertilizer

A thriving garden begins with healthy soil. Locally sourced in Houston, TX, this professional grade organic fertilizer has been trusted since 1988 to provide the best soil and plant nutrition possible. Completely safe for you, children and pets & will never burn your plants. With over 70 minerals, your plants will be more disease resistant, tastier, and more nutritionally dense for you & your loved ones.

MSRP

Model No	SFSL624-6	SFSL624-12
Size	6 lb . Bag	12 lb . Bag

Application Rates

New Garden Beds: 4 lbs per 32 sq ft

Reapplication: 2 lbs per 32 sq ft

To calculate the sq ft of your garden bed, multiply its length by its width (using ft.)





Model No.
VBXXX

Straw Mulch

Vego Garden Straw Mulch is the perfect solution to reduce water loss in raised garden beds. Sustainably sourced from Florida, each 18 lb bag of Straw Mulch covers up to 160 sq ft or 5 of the 4 x 8 ft garden beds with a 2-inch layer of mulch. This sustainable mulch helps reduce evaporation, maintains optimal soil temperature, protects against direct sunlight, and promotes a thriving microorganism ecosystem. With its natural and pleasing appearance, Straw Mulch adds aesthetic value to your garden. It is easy to store and blends into the soil over time, enriching it with nutrients.

Note: Though not certified organic, the clean processing of the straw may result in minimal straw seed content, which can easily be removed once sprouted and decomposes quickly on the mulch surface.

MSRP:69.95

Application Rates

Coverage: 160 sq ft per bag

One bag covers five 4 x 8 ft garden beds

Spread once per season

To calculate the sq ft of your garden bed, multiply its length by its width (using ft.)





Model No.
VTHRHR

10 in 1 Hori Hori Knife Kit

Sharpen your gardening skill with Vego Garden's 10 in 1 Hori Hori Knife Kit. This innovative tool takes a classic Hori Hori to the next level with 10 unique functions and a heavy duty case that clips right to your belt. This is sure to be the last garden knife you'll ever need!

MSRP: \$59.95

Dimensions

Blade: 7 inches long, 2 inches wide

Handle: 5 inches

Knife+ Case: 13 inches

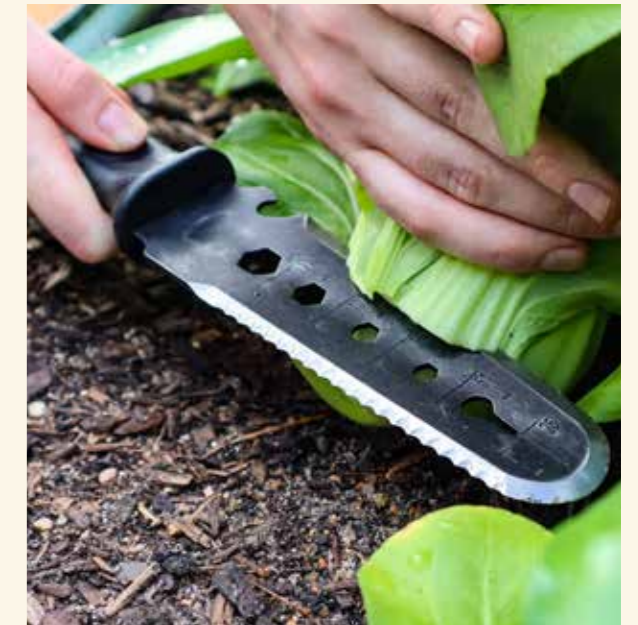



Modular Garden Sifter

Vego Garden's innovative Garden Sifter is modular, offering a removable screen for easy cleaning and flexibility. This Garden Sifter is perfect for sifting fine grain soil for seed starting, sifting compost, and easily & gently separating fresh worm castings from the hard working worms who created it. Ergonomically designed, and built to last from 304 stainless steel, this is certain to be the last sifter you'll ever need.

MSRP:49.95

Dimensions

Sifter: 14.5 in x 14.5 in x 3.3 in

Volume: Holds 0.4 cubic ft. of soil

Screen Size: Screen size 5mm x 5mm



Model No.
VSSS



Vego Salad Serving Bowl - 2 Pack- Pearl White

Garden-to-table just got more beautiful. Introducing Vego Garden's Salad Serving Bowls. Inspired by the iconic corrugated shape of our garden beds, and the perfect partner to the Vego Coffee Mug, the elegant, generously sized Vego Garden Salad Serving Bowls are the star of any table, and a fitting display for all of your harvests and recipes!

MSRP: \$49.95



Dimensions

Width: 10 inches

Depth: 2.24 inches

Standard Volume: 48 oz

Maximum Volume: 61 oz

Model No.
VSSB-2W



Vego Salad Serving Bowl - 2 Pack- Olive Green

Garden-to-table just got more beautiful. Introducing Vego Garden's Salad Serving Bowls. Inspired by the iconic corrugated shape of our garden beds, and the perfect partner to the Vego Coffee Mug, the elegant, generously sized Vego Garden Salad Serving Bowls are the star of any table, and a fitting display for all of your harvests and recipes!

MSRP: \$49.95



Dimensions

Width: 10 inches

Depth: 2.24 inches

Standard Volume: 48 oz

Maximum Volume: 61 oz



Model No.
VSSB-2G



Vego Salad Serving Bowl - 2 Pack- British Green

Garden-to-table just got more beautiful. Introducing Vego Garden's Salad Serving Bowls. Inspired by the iconic corrugated shape of our garden beds, and the perfect partner to the Vego Coffee Mug, the elegant, generously sized Vego Garden Salad Serving Bowls are the star of any table, and a fitting display for all of your harvests and recipes!

MSRP: \$49.95



Dimensions

Width: 10 inches

Depth: 2.24 inches

Standard Volume: 48 oz

Maximum Volume: 61 oz

Model No.
VSSB-2BG



Vego Salad Serving Bowl - 2 Pack- Modern Gray

Garden-to-table just got more beautiful. Introducing Vego Garden's Salad Serving Bowls. Inspired by the iconic corrugated shape of our garden beds, and the perfect partner to the Vego Coffee Mug, the elegant, generously sized Vego Garden Salad Serving Bowls are the star of any table, and a fitting display for all of your harvests and recipes!

MSRP: \$49.95



Dimensions

Width: 10 inches

Depth: 2.24 inches

Standard Volume: 48 oz

Maximum Volume: 61 oz

Model No.
VSSB-2MG





Model No.
VSSB-2W

Vego Coffee Mug-Pearl White

An early morning walk in the garden is a blessing for the whole day, and it will only be perfect with your favorite coffee. Inspired by the Herb Garden Bed shape, the Vego Coffee Mug is what you need in your hands every morning.

MSRP: \$19.95



Dimensions

Volume: 15.8 fl oz / 470 ml

Dimensions: 3.5 in. H x 4 in. L

Handle: 3 in. H x 1.5 in. W





Model No.
VSSB-2G

Vego Coffee Mug-Pearl White

An early morning walk in the garden is a blessing for the whole day, and it will only be perfect with your favorite coffee. Inspired by the Herb Garden Bed shape, the Vego Coffee Mug is what you need in your hands every morning.

MSRP: \$19.95



Dimensions

Volume: 15.8 fl oz / 470 ml

Dimensions: 3.5 in. H x 4 in. L

Handle: 3 in. H x 1.5 in. W





Model No.
VSSB-2BG

Vego Coffee Mug-British Green

An early morning walk in the garden is a blessing for the whole day, and it will only be perfect with your favorite coffee. Inspired by the Herb Garden Bed shape, the Vego Coffee Mug is what you need in your hands every morning.

MSRP: \$19.95



Dimensions

Volume: 15.8 fl oz / 470 ml

Dimensions: 3.5 in. H x 4 in. L

Handle: 3 in. H x 1.5 in. W





Model No.
VSSB-2MG

Vego Coffee Mug-Modern Gray

An early morning walk in the garden is a blessing for the whole day, and it will only be perfect with your favorite coffee. Inspired by the Herb Garden Bed shape, the Vego Coffee Mug is what you need in your hands every morning.

MSRP: \$19.95



Dimensions

Volume: 15.8 fl oz / 470 ml

Dimensions: 3.5 in. H x 4 in. L

Handle: 3 in. H x 1.5 in. W





Model No.
VGB1GY

Vego Garden Bag

The Vego Garden Tool Bag is the perfect for storing tools, water, and anything else you need for a day out in the garden! Overbuilt and designed for utility and comfort, this compact 5 gallon bag is a versatile aid to gardeners of any skill level. The last garden bag you'll ever need to buy.

*Tools not included

MSRP: \$119.95

Dimensions

Volume: 5 gallons

Dimensions: 7.5" L x 13.5" W x 11.5" H

Materials

Exterior: Overbuilt, puncture-resistant shell

Interior: TPU waterproof liner

Straps: Heavy duty nylon webbing

Bottom: Sturdy molded bottom





Model No.
TGPG2023

Texas Gardener Magazine Planning Guide 2023

Our trusted friends at Texas Gardener Magazine create a yearly planning guide for gardens in Gulf South. The 2023 Planning Guide provides day by day tips and room to record all of the important dates and events in your garden. Planning your garden helps ensure successful harvests, so this guide is a must-have for every gardener!

Note: This guide is designed for use across the entire Gulf South (USDA hardiness zones 6b-10a.)

MSRP: \$18.95

Dimensions

Volume: 5 gallons

Dimensions: 7.5" L x 13.5" W x 11.5" H

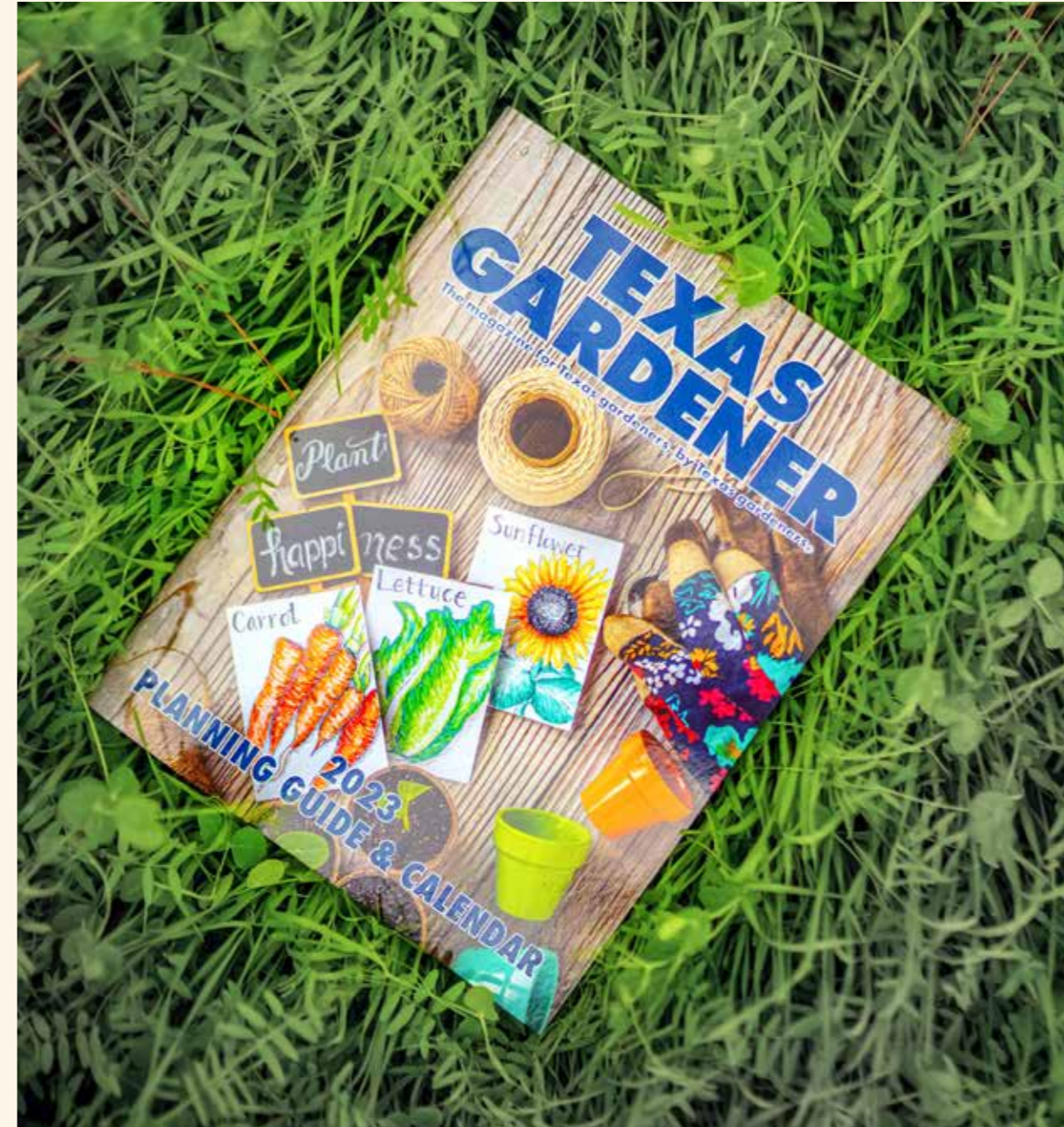



Locally Sourced Organic Worm Castings

Ready to take your gardening to the next level? Vego Garden is now offering Omri-Certified, organic worm castings sourced from our incredible local partners The Magic Worm Ranch! Worm castings are a gentle, effective, natural fertilizer produced as a byproduct by worms that provide essential nutrients to plants such as potassium, nitrogen, and phosphorus. These rich, organic worm castings also improve soil structure by increasing aeration, improving drainage, and enhancing moisture retention all at the same time! By purchasing worm castings through us here at Vego Garden you are helping support a remarkable small business here in Texas, and are helping to rebuild the life of our Earth's soil!

Note: Worm Castings do not contain live worms

Model No	TPWC-6LB	TPWC-12LB
Size	6 lb . Bag	12 lb . Bag



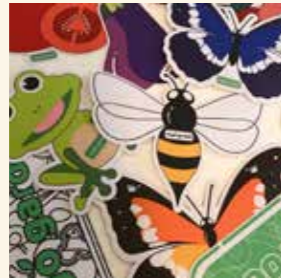

Vego Sticker Kit

Decorate your Vego Garden Beds with these AMAZING stickers! These stickers are made from high quality 3M material so they will last a long time whether you use them indoors or outdoors on your garden beds! 5" - 7" wide with matte finish

Model No	Kit
VSGCK	Garden Creatures Kit
VSVHK	Veggie Harvest Kit
VSVGK	Vego Garden Kit
VSC3K	Combo-All 3 Kits

Vego Garden eGift Card

Gifting a garden is just like gifting happiness. Send the best gift to your loved ones! They never expire, they're good for all our products, and no postage needed.

Denominations	\$25	\$50	\$100	\$200	\$500

Terms and Conditions

Vego Garden eGift Cards are digital gift cards and sent via email. Vego Garden eGift Cards are redeemable towards the purchase of eligible goods and services online at <https://Vegogarden.com> or a Vego Garden Customer Service Representative. If a purchase exceeds the balance on your eGift Card, the remaining amount must be paid with another payment method. Upon redemption, any unused balance will remain on the Gift Card for future purchases. Gift Cards cannot be returned; resold; cancelled; used to purchase other Gift Cards; used for unauthorized advertising purposes; redeemed for more than face value; transferred for value; or redeemed for cash or returned for a cash refund (except to the extent required by law). We reserve the right to make changes to these Gift Card Terms, at any time without notice, from time to time at our sole discretion.



CONTACT US



HQ Address: 1521 Greens Rd # 100 Houston, TX 77032



Phone: (866) 597-1888



Website: <https://vegogarden.com/>



Email: hello@vegogarden.com