



# ▶ CONTENTS



## 3 About Bird-X

## 4 Bird Netting

Exclusion netting prevents pest birds from entering specific areas – when installed properly, it is 100% effective.

## 5 Netting Hardware

Commercial-grade hardware needed to install Bird-X BirdNet – cables, screws, nuts, brackets, turnbuckles, ferrules, and more.

## 7 Bird Spikes

Bird spikes protect surfaces from pest bird infestation. Available in Stainless Steel or Plastic. Available in multiple lengths, heights, and widths.

## 9 Avishock™, Hardware & Chargers

Avishock™ track gives a mild electric shock when touched, conditioning birds and pest rodents to stay away from treated surfaces.

## 11 AviAngle™

AviAngle™ is a modular ledge exclusion system that prevents all pest birds and wildlife from landing on ledge-based areas

## 12 Bird Wire & Post

Bird Wire is great for high-profile ledges where a less visible solution is needed. Wires are installed at differing heights making it difficult for birds to land.

## 13 Solar Mesh Guard Kit

Solar Mesh Kits protect the roof, electrical wiring and solar panels from pest damage.

## 14 Indoor & Outdoor Laser Bird Control

Colored Laser Array frightens and deters birds for up to 10,000 sq. ft.

## 15 Gels, Liquids and Visual Deterrents

Bird Proof Gel, liquids, taste aversions, visual deterrents, and other sensory deterrents.

## 16 Sonic & Ultrasonic Electronic Bird Repellers

Electronic repellers provide effective, money-saving, humane bird control solutions.

## 18 Pigeon & Sparrow Traps

Humane traps allow birds a way in, but can only be removed manually

## 19 Bird Balls

Floating covers protect bodies of water from birds & other wildlife with up to 99% coverage



# BIRD-X

Humane Bird Control Solutions



*Humane & Eco-friendly Solutions*  
*Experienced Sales Consultants*  
*Unmatched Quality*  
*Worldwide Distribution*  
*Industry-Leading Customer Service*

Bird-X is the leading brand of *humane* and *eco-friendly* bird and wildlife control solutions worldwide—protecting human health, wildlife and the environment.

Established in 1964, our Chicago-based company manufactures a complete line of unique bird control products with an unmatched focus on quality, efficacy and customer service.

Bird-X works closely with professional installers and pest management professionals on projects of all sizes.

ASK ABOUT BECOMING A  
BIRD-X CERTIFIED INSTALLER

**BIRD-X**  
Certified Installer



800-662-5021 or 312-226-2473



solutions@bird-x.com



www.bird-x.com

# ▶ NETTING

## PREMIUM BIRDNET

This polyethylene netting is a permanent solution, ideal for commercial projects. The material is lightweight, pliable, maintenance-free, and durable. 10 year warranty.



**3/4" Black Polyethylene Knotted Net**  
25'x25'.....625 sq. ft.....[NET-PE-25-25](#)  
25'x50'.....1,250 sq. ft.....[NET-PE-25-50](#)  
50'x50'.....2,500 sq. ft.....[NET-PE-50-50](#)  
50'x100'.....5,000 sq. ft.....[NET-PE-50-100](#)  
100'x100'...10,000 sq. ft...[NET-PE-100-100](#)  
100'x200'...20,000 sq. ft...[NET-PE-100-200](#)

**2" Black Polyethylene Knotted Net**  
25'x25'.....625 sq. ft.....[NET-PE-25-25-2](#)  
25'x50'.....1,250 sq. ft.....[NET-PE-25-50-2](#)  
50'x50'.....2,500 sq. ft.....[NET-PE-50-50-2](#)  
50'x100'.....5,000 sq. ft.....[NET-PE-50-100-2](#)  
100'x100'...10,000 sq. ft...[NET-PE-100-100-2](#)



**3/4" Stone Polyethylene Knotted Net**  
25'x25'.....625 sq. ft.....[NET-PE-25-25-STONE](#)  
25'x50'.....1,250 sq. ft.....[NET-PE-25-50-STONE](#)  
50'x50'.....2,500 sq. ft.....[NET-PE-50-50-STONE](#)  
50'x100'...5,000 sq. ft.....[NET-PE-50-100-STONE](#)

**1 1/8" Black Polyethylene Knotted Net**  
25'x25'.....625 sq. ft.....[NET-PE-25-25-1](#)  
25'x50'.....1,250 sq. ft.....[NET-PE-25-50-1](#)  
50'x50'.....2,500 sq. ft.....[NET-PE-50-50-1](#)  
50'x100'...5,000 sq. ft.....[NET-PE-50-100-1](#)

## STRUCTURAL BIRDNET

This 1/2" standard mesh netting is a great economical solution for homeowners and gardeners. It is lightweight, pliable and weatherproof.

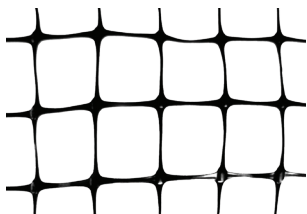

**1/2" Black Polypropylene Net**  
100'x14'.....1,400 sq. ft.....[NET-STR-100](#)  
200'x14'.....2,800 sq. ft.....[NET-STR-200](#)

## STANDARD BIRDNET

This 3/4" polypropylene is perfect for small businesses, homeowners, farmers, and gardeners. It is durable, plastic netting that is lightweight, pliable, and resistant to elemental damage. Lasts up to 5 years.

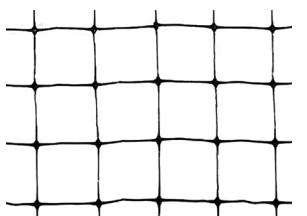

**3/4" Black Polypropylene Net**  
100'x14'.....1,400 sq. ft.....[NET-STD-100-14](#)  
200'x14'.....2,800 sq. ft.....[NET-STD-200-14](#)



# NETTING HARDWARE

## Bird Netting Install Overview

Corner/Primary attachments are under the most pressure and must be the strongest component in the system; be sure all attachments are firmly anchored. Be sure to install attachments every 45-50 feet for large jobs.

## Intermediate Attachments

These hold the cable tight against the structure to prevent bowing (giving birds room to enter/exit the area of coverage). Intermediate attachments should be installed every foot.

## Stringing Wire/Cable & Ferrules

The perimeter cable frames the entire area to support the netting. Ferrules secure the cables where they attach to the turnbuckles. Slide the ferrules onto the cable before you form your connecting loop and secure it to the cable with the ratchet tool. Be sure to use at least two ferrules per loop to ensure strength and durability of the perimeter cable.

## Turnbuckles

Turnbuckles also must be well anchored as they are subject to a great deal of tension between the cable and the corner attachments – be sure your components are well secured. When installing, make sure the turnbuckles are all the way open. Pull the cable as tight as possible through the turnbuckle. Before tightening, be sure all slack in the cable is removed, taking up as much tension as possible and fasten with a screwdriver, etc. Be sure not to pull out any fasteners or eyehooks when tightening.

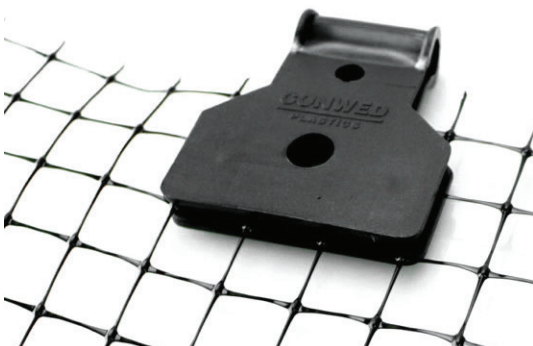

## Mounting Cable

500' Spool, 49 Strand Cable. Cable, 7x7, 3/32" (2mm) diameter with 920 lb. tensile. Stainless steel.

3/32"

**MTG-CABLE-SS**

1/16"

**MTG-CABLE-SS-1/16**

1/8"

**MTG-CABLE-SS-1/8**



## Lag Eye Screw

1/2" lag eye screw.

**Stainless Steel (10 pack)**

**MTG-LAG-SCREW-SS**



## Screw Eye

For wood or thick sheet metal surfaces. Corner/end attachment. 17/32" I.D., 1" lag thread.

**Stainless Steel (10 pack)**

**MTG-SCREW-MD-SS**



## Eyebolt w/Nut

Corner/end attachment for an I-beam or other thick metal.

**Stainless Steel (10 pack)**

**Galvanized (10 pack)**

**MTG-BOLT-MD-SS**

**MTG-BOLT-MD**



## Net Concrete Spikes

This hammer-in attachment can be used for stone, concrete or solid brick. It does not require a plastic anchor sleeve; the bent shaft holds it securely in place. Zinc coated.

**Stainless Steel Net Spikes**

**Galvanized Net Spikes**

**Small (100 pack)**

**Small (100 pack)**

**MTG-SPIKES-SS**

**MTG-SPIKES**



## Eyebolt Anchor

Corner/end attachment. M6 high load bearing expansion bolt anchor. For most masonry, stone, or concrete. This M6 netbolt needs a 14mm drill bit.

**Stainless Steel (10 pack)**

**MTG-NETBOLT-MD-SS**



## Mounting Clips

Install Bird-X netting easily. Heavy-duty clips snap onto netting edges and hold securely. Installs easily with screws, nails, adhesive, cable, or velcro.

**(250 pack)**

**MTG-CASE**



# ▶ NETTING HARDWARE

## Multi-Purpose Cable Bracket

1.25" bracket is used as an end or immediate bracket and installed as either a permanent fixture or as a quick release cable holder. 100 per pack.

*Stainless Steel (100 pack)*

**MTG-BRACKET-SS**



## Heavy Duty Steel Clamp

This clamp can hold up to 630 pounds of tension weight. Bolt to an I-beam or other steel structure and run your cable inside the jaws. Opens up to 3/4".

*Stainless Steel Clamp (10 pack)*

**MTG-CLAMP-1-SS**



## Girder Clip

This strong, hammer-on clip allows you to attach cable to hard-to-drill steel beams. Hammer the clip into the edge of an I-beam with the cable running through the jaws (not through the hole), and your cable is secure. SS at the end of a part # indicates Stainless Steel.



*1/8" – 1/4" (100 pack)*

**MTG-GIRD-1**

**MTG-GIRD-1-SS**

*5/16" – 1/2" (100 pack)*

**MTG-GIRD-2**

**MTG-GIRD-2-SS**

*3/16" – 3/4" (100 pack)*

**MTG-GIRD-4**

*3/4" – 1" (100 pack)*

**MTG-GIRD-5**

**MTG-GIRD-5-SS**

## Turnbuckles

Hook-and-Eye Turnbuckles for tensioning Net Cable.

*Stainless Steel Turnbuckles (10 pack)*

*Medium, 1/4" x 3-1/2" (Call for other size options)*

**MTG-TURN-MD-SS**



## Ferrules, 2.5MM

Double Sleeve Zinc/Copper Ferrules. For connecting cable runs (3/32"). Ratchet Crimper required. Two (2) ferrules per cable connection.

*Copper (100 pack)*

**MTG-FERR-C**



## Bracket with Hilti Pin

Used as a corner or intermediate attachment or as a quick-release cable holder.

**MTG-BRACKET-HILTI PIN**



## Net Ring Tool

Hand operated, auto-feed Ring Tool. Installs net rings around net, cable, zippers, etc.

**MTG-RING-TOOL**



## Net Rings

Net rings secure seams and fasten the Netting to the cable, zippers, etc. Ring Tool required. 2,500 per pack.

*Stainless Steel*

**MTG-RINGS-SS**

*Galvanized*

**MTG-RINGS**



## Net Access Clip

Connect pieces of netting together securely with stainless steel clips.

*3/4" Stainless Steel (100 pack)*

**MTG-ACCESS-CLIP**

*2" Stainless Steel (100 pack)*

**MTG-ACCESS-CLIP2**



## Net Zipper

UV resistant black zipper. Fasten to netting with net rings and ring tool.

*1' Black, 5MM*

**MTG-ZIPPER-1**

*3' Black, 5MM*

**MTG-ZIPPER3**

*6' Black, 5MM*

**MTG-ZIPPER**



## Net Ratchet Crimp Tool

Hand operated, ratcheting Crimper for ferrules.

**MTG-RATCHET**



## Pneumatic Ring Tool

16 gauge 3/4" C-Ring. Magazine capacity of 125.

**MTG-PN-RINGTOOL-3/4**

**MTG-PN-RINGTOOL-1/2**

**MTG-PN-RINGTOOL-1**



# STAINLESS STEEL BIRD SPIKES

Bird-X Stainless Steel Bird Spikes are resistant to weather, corrosion and decay. The flexible base allows for installation on curved surfaces. Stainless Steel Spikes have a 10-year warranty against material defects. CAD files and documented specifications available upon request.



## Narrow Bird Spikes

- Top width: 2.5"
- Base width: 0.5"
- Highest point: 4.3"
- 10 ft.....**SLS-10**
- 24 ft.....**SLS-24**
- 50 ft.....**SLS-50**
- 100 ft.....**SLS-100**

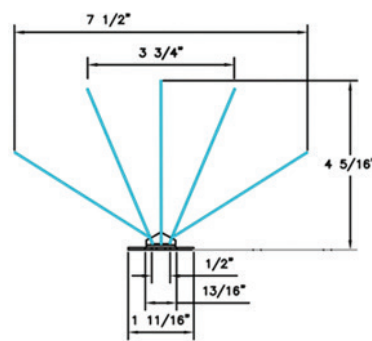
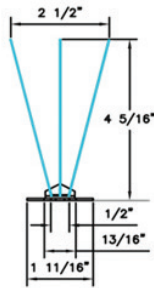

## Extra Wide Bird Spikes

- Top width: 7.5"
- Base width: 0.5"
- Highest point: 4.3"
- 10 ft.....**EWS-10**
- 24 ft.....**EWS-24**
- 50 ft.....**EWS-50**
- 100 ft.....**EWS-100**

## Standard Bird Spikes

- Top width: 4.5"
- Base width: 0.5"
- Highest point: 4.3"
- 10 ft.....**STS-10**
- 24 ft.....**STS-24**
- 50 ft.....**STS-50**
- 100 ft.....**STS-100**

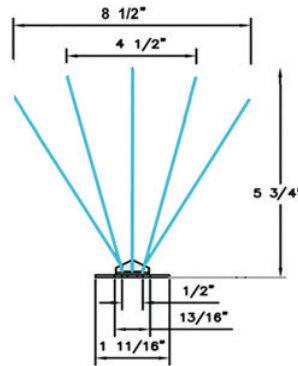
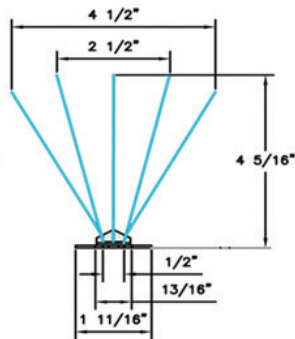

## Extra Tall Bird Spikes

- Top width: 8.5"
- Base width: 0.5"
- Highest point: 5.75"
- 98 ft.....**ETS-98**

## Spikes Special Adhesive

Designed for installing Bird-X Spikes. One (1) tube adheres 15-20 feet of spikes. *Weatherproof; works on a wide range of materials.*

10.5 oz. tube  
SSA

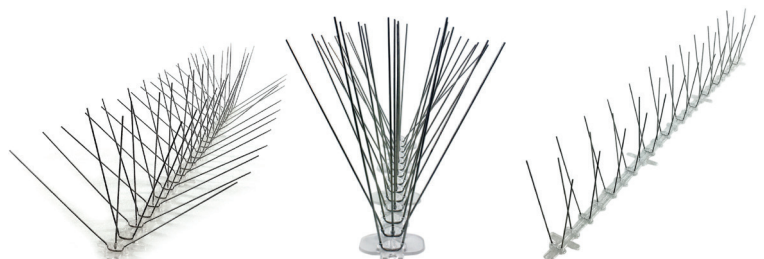

# ▶ PLASTIC BIRD SPIKES

Bird-X Plastic Bird Spikes are made of durable, weather-resistant polycarbonate. The flexible base allows for easy installation on curved surfaces. Plastic spikes have a 5-year warranty against material defects. CAD files and documented specifications available upon request.



## Narrow Bird Spikes

Top width: 2.5"

Base width: 0.75"

Highest point: 4.75"

10 ft.....**SP-10-N**

25 ft.....**SP-25-N**

50 ft.....**SP-50-N**

100 ft. ....**SP-100-N**

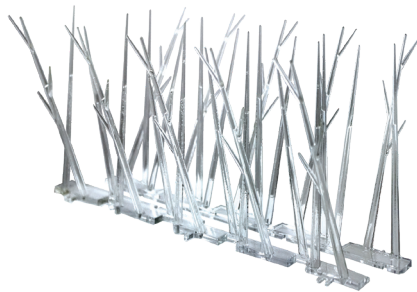

## Standard Bird Spikes

Top width: 4.5"

Base width: 1.75"

Highest point: 4.75"

10 ft.....**SP-10**

25 ft.....**SP-25**

50 ft.....**SP-50**

100 ft.....**SP-100**



## Spikes Special Adhesive

Designed for installing Bird-X Bird Spikes. One (1) tube adheres 15-20 feet of spikes. *Weatherproof; works on a wide range of materials.*

10.5 oz. tube

SSA





# SHOCK TRACK & HARDWARE

Train birds to stay away with electrified track that conforms to any structure. Avishock™ is flexible, low-profile and long-lasting. It was created with easier and safer installation in mind, featuring snap connectors, longer rolls, no sharp parts to reduce risk of injury, and a flatter base to reduce the use of glue.



## AVISHOCK™ TRACK

Brand new, low-profile design makes Avishock™ Track ideal for preserving building aesthetics.

Fewer energizers (and power sources) are required, making installation quick and easy and reducing overall material costs. Our copper strips are fully encased and durable despite weather conditions. Reliable performance over a long period of time due to UV and weather-resistant materials.

Favored by project owners, architects, and installers over other solutions when aesthetics are vital. Used extensively on heritage sites and challenging or modern building designs.

65 ft. Rolls



*Black*

SHK102



*Stone*

SHK101

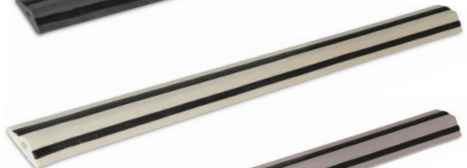

*Grey*

SHK105

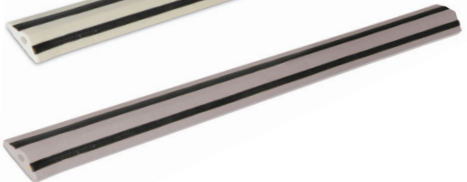

**Straight Connector (x20)**  
SHK121



**Corner Connector (x20)**  
SHK122



**Jumper (x20)**  
SHK123



**Female Spade Connectors (x100)**  
SHK023-100



**Male Spade Connectors (x100)**  
SHK029-100



**Connector Ring Terminal (x10)**  
SHK024



# ▶ SHOCK TRACK & HARDWARE

## Special Adhesive

Used to adhere Shock Track to a variety of surfaces. Weatherproof; works on a wide range of material.

10.5 oz. tube

SSA



## Digital Voltage Tester

Used to test that the track is powered. Tester reads in 100v increments up to 10,000. Put one probe to one track braid and the other to the second track braid. The reading should be between 5,000v and 9,000v (5.0 - 9.0kV)

SHK051



## Warning Plates (x25)

Hard-wearing plastic

SHK032



## Warning Window Stickers (x100)

SHK033



## Lead Wire (65')

Heavily insulated, twisted copper is easy to cut, strip and crimp. Used for connecting track to track to energizer.

Brown: SHK111

Black: SHK112

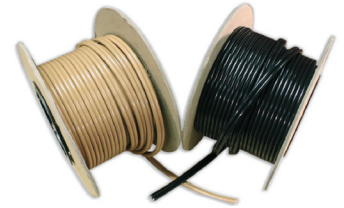

## Solar Charger

300-2,500 ft. of track

Solar-powered charger with weather resistant case.

SHK-C-SOL



## Wire Guides screw on (x100)

SHK031



## Wire Guides stick-on (x50)

SHK034

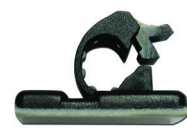

## 110V AC Charger

300-1,000 ft. of track

SHK-C-110



## Avishock™ Shears

Ideal for cutting Avishock™ track and lead wire.

SHK136



## 12V Battery Charger

300-2,500 ft. of track

SHK-C-12V



## Connector Crimp Tool

Used to crimp the Connectors to the Lead Wire.

SHK052



## Wire Stripping Tool

Used to strip the insulation from the Lead Wire.

SHK053

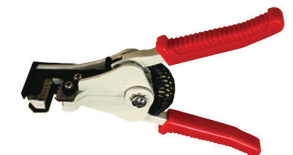

## Avishock™ 45° Cutting Guide

Ensure quick and accurate mitre cutting. Simply line up against the track and cut along the edge.

SHK054





## AVIANGLE™

AviAngle™ is a modular ledge exclusion system that prevents all pest birds and wildlife from landing on ledge-based areas. The smooth surface of the UV-protected PVC material prohibits birds and from landing and getting a stable foothold. AviAngle™ is resistant to virtually all weather conditions and harsh environments when installed according to manufacturer instructions.

AviAngle™ can be installed using Bird-X Special Adhesive, wood screws, nails or clamps, depending on the surface area and the application. AviAngle™ Base Unit will cover approximately 6" of ledge depth, comes in four (4') linear foot sections and is packaged in 12 sections per box for a total of forty-eight (48') linear feet per box.

### AVI-ANGLE

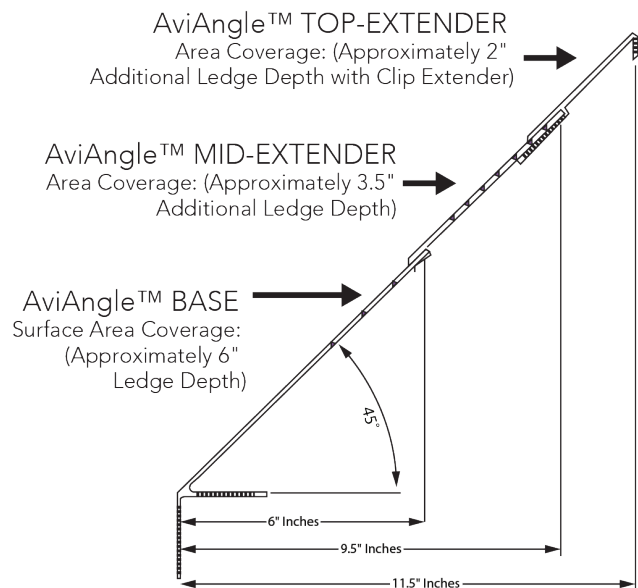

[VIEW THE AVIANGLE VIDEO GALLERY](#)



# ▶ BIRD WIRE & POST PRODUCTS

## Bird Wire Cable

Stainless steel wire. 1X7 nylon-coated. Diameter is 0.7mm.

- 250'
- BW-WIRE-250**
- 500'
- BW-WIRE**
- 1,000'
- BW-WIRE-1K**



## Glue-On Bases (10 pack)

Bases can be glued or screwed to surfaces. Posts are inserted in bases.

- Black**
- BW-BASE-BLACK**
- Grey**
- BW-BASE**
- Tan**
- BW-BASE-TAN**



## Standard Springs (100 pack)

Easily attach Bird Wire to posts.

**BW-SPRING**



## Micro Springs (100 pack)

Easily attach Bird Wire to posts.

**BW-SPRING-M**



## Crimps (100 pack)

To fasten Bird Wire to posts by threading it through crimps.

**BW-CRIMP**



## Posts (100 pack)

Stainless Steel Posts have flattened heads with hole for wire.

- 3.5"
- BW-POST-3.5**
- 4.5"
- BW-POST-4.5**
- 5"
- BW-POST-5**
- 6"
- BW-POST-6**



## Railing Clamps (10 pack)

Use to attach wire to round surfaces, such as pipes and posts.

- 1" Diameter
- BW-CLAMP-1**
- 2" Diameter
- BW-CLAMP-2**
- 3" Diameter
- BW-CLAMP-3**
- 4" Diameter
- BW-CLAMP-4**
- 6" Diameter (2 posts)
- BW-CLAMP-6**



## Triangular Ridge Bracket

Runs birdwire along roof ridges. Flexible base fits any angle or roof fridge. Includes three 3.5" posts.

**BW-BRACKET-TRI**



## Vertical Post & Wire Clamp

Stainless Steel Clamp used to install birdwire post to gutter bead, metal roof, or other vertical surfaces.

3.5" x 0.16"  
**BW-CLAMP-V**



## Horizontal Post & Wire Clamp

Stainless Steel Clamp used to install bird wire post to an I-beam or other horizontal steel surface.

3.5" x 0.16"  
**BW-CLAMP-H**





## SOLAR MESH KIT

Our solar mesh exclusion system secures around the perimeter of solar panels to exclude birds and animals from underneath the panel. The mesh is made of stainless steel welded into 1/2" squares and coated in thick, protective PVC coating that is resistant to UV degradation and chemical corrosion. Bespoke panel clips are made from UV protected nylon and secures mesh without damaging or voiding the panel warranty. Solar mesh can be mounted to any solar panel with a bracket depth of greater than 30 mm.

### Solar Kit

Includes 100 ft. of 8" mesh and 100 fastening clips.

### SOLAR KIT

Includes 100 ft. of 6" mesh and 100 fastening clips.

### SOLAR KIT-6

### Mesh Only

Material: 302 stainless steel

Length: 100 ft.

Wire gauge: 0.7 mm

Width: 8" (SOLAR KIT) or 6" (SOLAR KIT-6)

PVC thickness: 0.3 mm

Grid: 1/2" squares

### SOLAR MESH

### Fastening Clips Only

Material: UV protected nylon

Length: 123 mm

Clip depth: 32 mm

Width: 10 mm

Count: 100 pieces

### SOLAR CLIP



EASY TO INSTALL.  
WATCH OUR VIDEO.



# ▶ LASER BIRD CONTROL

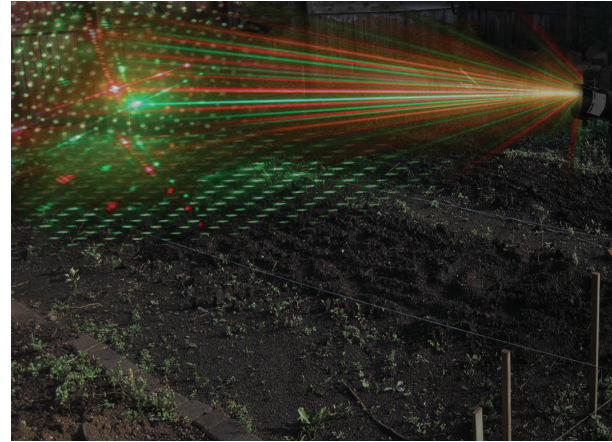

## BIRD-X LASERS

Indoor & Outdoor Laser Deterrent Devices flash the area and the pest with disorienting laser light and they quickly learn that this area is unwelcoming. Since the deterrent works by bothering the pests' eyesight, it is reliably effective against a huge variety of pest animals. Bird-X Laser Devices use "Fat Beam" technology to ensure our units are safe to use near humans while being strong enough to deter the pests.

### Includes:

- ✓ Mounting Accessories
- ✓ Remote Control with Timer Options
- ✓ Power Cord

### Indoor & Outdoor Laser Specifications:

- Laser color: Red + green
- Net Weight: 1.5kg
- Power: AC100-240V, 50-60Hz
- Electric Current: 100mA
- Classification: CLASS 3R
- Fuse: 2A
- Housing: Cast aluminum
- Beam Divergence: 60°



**BX-LASER-IN**



**BX-LASER-OUT**



# GELS, LIQUIDS AND VISUAL DETERRENENTS

## Bird Deflector

Uses sunlight and wind to create flashing lights during daylight hours to deter seagulls and other migratory birds. Can be screwed or glued into place. Equipped with adjustable angle arm for multiple positions.

*Aluminum and plastic design*

**BD**



## Daddi Long Legs

Thin, stainless steel rods constantly move to interfere with birds' wings when they attempt to land. Design is unobtrusive and practically invisible from a distance.

**DLL-2**

**DLL-4**

**DLL-6**

**DLL-8**



## Bird Proof Gel

Surface Repellent Gel; tacky substance keeps birds off surfaces. Discreet and low-profile, perfect for signs and entrances.

*12 tubes per case*

**BP-CART**



## Bird Free Optical Deterrent Gel Cups

Gel Cups create an illusion of fire using birds' ability to see ultraviolet light. This makes the area appear dangerous and uninhabitable to pest birds.

*15 cups per box*

**BP-CUPS**



## 4 The Birds: Repellent Liquid

Transparent, sticky liquid makes surfaces tacky and uncomfortable to birds.

*Gallon*

**BP-LIQ-1**



## Bird Stop

Taste aversion, liquid bird deterrent with a smell and taste that birds avoid.

*Gallon*

**BS-GAL**



## Safety Solvent Cleaner

Safely cleans and removes Bird Proof Liquid and/or Gel from surfaces.

*Gallon*

**BPS-GAL**



## Evo Blend Microbial Bird Dropping Cleaner

The Evo Blend Microbial Bird Dropping Cleaner's formulation helps break down and remove bird dropping build-up in a safe and effective manner on hard, nonporous surfaces.

The Cleaner is made up of non-harmful surfactants and probiotic microbes that are specifically bred to be especially effective on urine and fecal material.

*1 Gallon*

**BX-EVO**



# ▶ SONIC & ULTRASONIC DETERRENENTS

## Super BirdXPeller PRO

These units cover areas up to 6 acres.

*Version 1 repels: Pigeons, Starlings, Sparrows, & Gulls*

**SBXP-PRO-1**

*Version 2 repels: Crows, Blackbirds, Grackles, Cormorants, & Ravens*

**SBXP-PRO-2**

*Version WP repels: Woodpeckers & Sparrows*

**SBXP-PRO-WP**

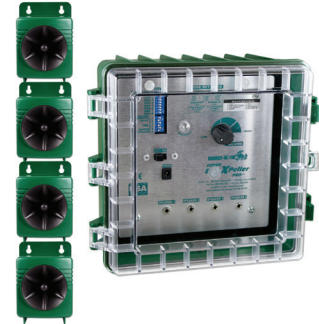

## BroadBand PRO

Both Sonic & Ultrasonic Bird Repeller. Covers up to 6 acres. Option to include 3 visual scares

**BB-PRO**



## GooseBuster

Sonic Goose Control Device uses authentic recordings of Canada geese alarm and alert sounds to deter geese. Covers up to 7 acres.

**GB**

---

## Solar Panel

Solar Panel converts sunlight into electricity and charges 12v batteries for DC (direct current) appliances. Works with Bird-X sonic devices.

**5W**

**SOLPAN**

**25W**

**SOLPAN2**



---

## Ultrason X

Ultrasonic Bird Repellers are simple to install, extremely low-profile, & highly effective. Repel pest birds discreetly & permanently using silent-to-humans ultrasonic sound waves. Ultrasonic technology is irritating & disorienting to birds, but remains a safe, humane & eco-friendly option. These units cover areas up to 3,600 sq. ft.

**USX**





# SONIC & ULTRASONIC DETERRENENTS ◀



ASK ABOUT OUR AIRPORT BIRD CONTROL SYSTEM

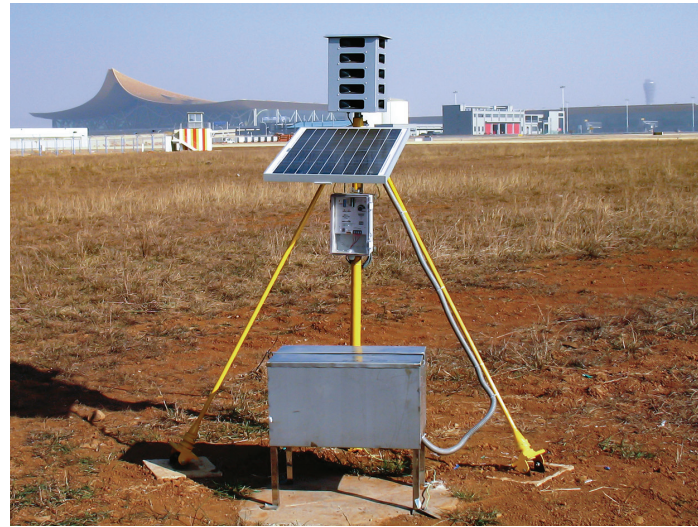

## Mega Blaster PRO

Our most powerful sonic system features two high-output amplifiers that drive our specially-designed 20 speaker tower. Solid-state electronics are mounted inside a NEMA-type control box, suitable for almost any large outdoor application. The intense sound output covers up to 25 acres, broadcasting distress calls at up to 125 decibels that frighten birds away for good.

MEGA

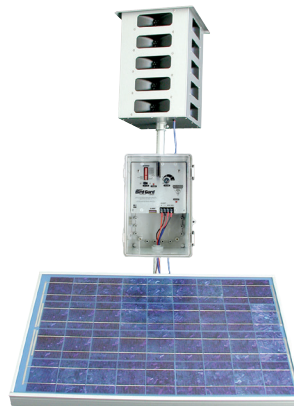

## QuadBlaster QB-4

The QuadBlaster QB-4 is an indoor ultrasonic bird control system composed of 4 built in speakers and solid steel construction. Optional powerful flashing strobe light add-on creates a multi-sensory attack to frighten pests away from the area. The QB-4 covers up to 6,500 sq. ft. in enclosed or semi-enclosed areas.

*QB-4 only*

QB4

*QB-4 + Strobe*

QB4+S



# ▶ TRAPS

## Pigeon Traps

Shade, water & feed container included

35" x 16" x 8"

PT3516/S/W/F

Shade, water & feed container included

46" x 24" x 10"

PT4624/S/1GW/F

Shade included

35" x 16" x 8"

PT3516/S

Trap only

35" x 16" x 8"

PT3516

Collapsible to 1" high

24" x 12" x 8"

PT2412/KD

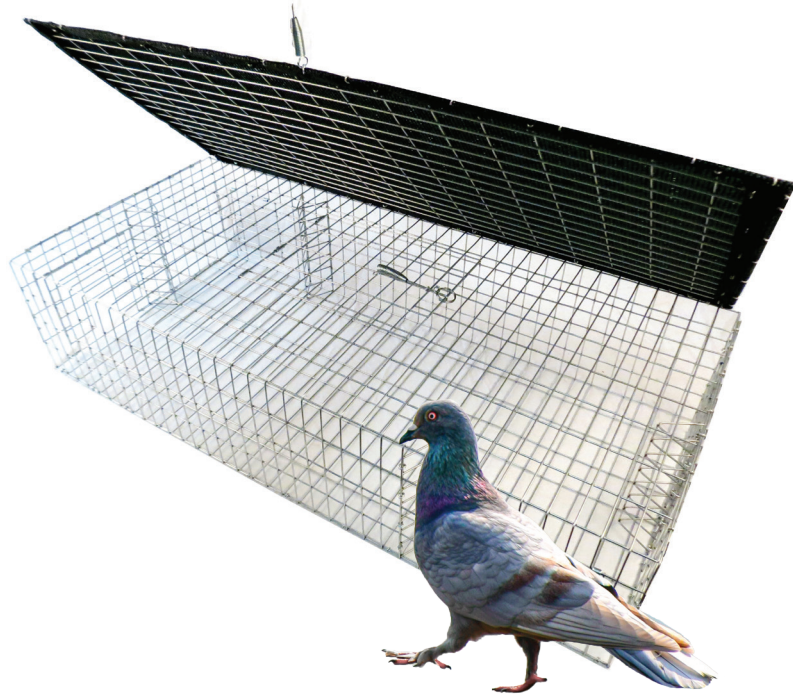

---

## Sparrow Traps

Trap only

16" x 12" x 6"

SP2

Water & feed container included

36" x 24" x 10"

SP3/W/F

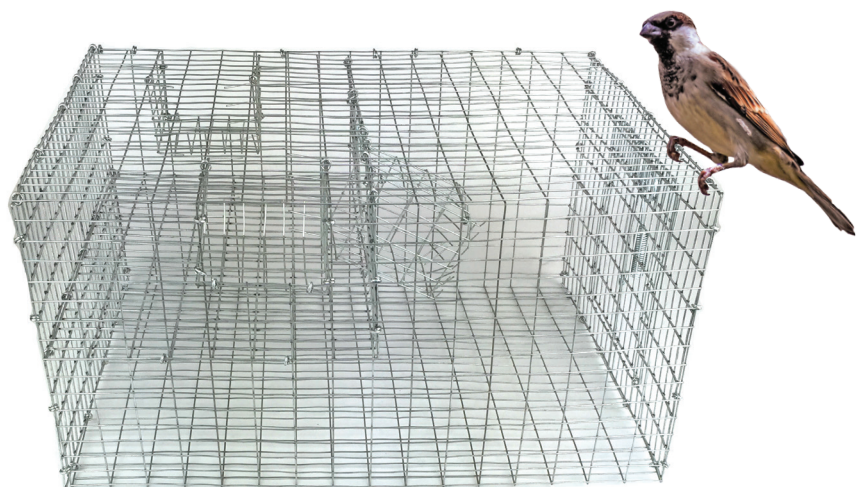



**UP TO 99% SURFACE COVERAGE**

## BIRD BALLS

Bird balls are floating bird and wildlife deterrents that rest on the surface of the water and block geese, ducks, swans, gulls, and other wildlife from entering bodies of water. The water becomes unattractive to the pest birds and wildlife — they simply don't recognize it as water. Bird Balls are weather-resistant, durable, long-lasting, and require little to no maintenance.

All floating cover options are made of 100% high-density polyethylene (HDPE). Food safe. Fully recyclable. A 10-year warranty against cracks and other wear is included.

### PRODUCT BENEFITS

- ✓ Quick and simple to install
- ✓ Virtually maintenance free
- ✓ Long-lasting
- ✓ Unaffected by rainwater, snow and frost
- ✓ Bird & wildlife control
- ✓ Odor control
- ✓ Algae control
- ✓ Heating cost reduced by up to 85%
- ✓ Decrease liquid loss through evaporation by up to 95%
- ✓ Reduce chemical consumption

### Armor Ball AQUA

Covers up to 90% of water surface. Product duration 25 years.

*HDPE*

**B-BALLS-ARM-B-AQ**



### Hexprotect AQUA

Covers up to 99% of water surface. Product duration 20-25 years. Will not stack, roll, or blow in the wind. Product maintains coverage in open spaces with high wind exposure.

*HDPE*

**B-BALLS-HT-AQ-CUS**

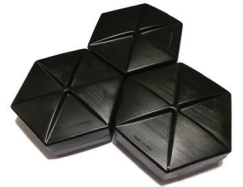

### Rhombo Hexoshield

Covers up to 99% of water surface. Product duration 20-25 years. Reduces evaporation up to 95%. Recommended in applications with tight fitting areas such as clarifiers, pools and water troughs.

*HDPE*

**B-BALLS-RHC-B-AQ-CUS**





## CONTACT US

800-662-5021 or 312-226-2473  
solutions@bird-x.com  
www.bird-x.com

